

VC-B30U PTZ Video Camera

Installation Guide - English



[Important]

To download the latest version of Quick Start Guide, multilingual user manual, software, or driver, etc., please visit Lumens
<http://www.MyLumens.com>

Table of Contents

Copyright Information	3
Chapter 1 Safety Instructions	4
Chapter 2 Package Contents	6
Chapter 3 Product Overview	7
3.1 Overview.....	7
3.2 Description of LED indicator	8
3.3 System Requirements	8
Chapter 4 Instruction for installation	9
4.1 Preparation before installation.....	9
4.2 Instruction for installation.....	9
4.3 Connecting the device.....	13
Chapter 5 Setting Menu Description	16
5.1 Functions of remote control.....	16
5.2 Setting Menu	17
Chapter 6 Descriptions of Major Functions	24
6.1 I would like to switch camera.....	24
6.2 I would like to control the camera.....	24
6.3 I would like to save the current lens position data.....	24
6.4 I would like to clear the saved position data.....	24
6.5 I would like to turn on the back light compensation function	25
6.6 I would like to adjust the shooting angle of the lens.....	25
6.7 I would like to zoom in/out images	25
6.8 I would like to adjust the focal length	25
6.9 I would like to adjust the AF speed.....	26
6.10 I would like to set the image mode	27

6.11 I would like to freeze images	27
6.12 I would like to rotate the image.....	27
6.13 I would like to change the camera direction	27
6.14 I would like to display the current status	27
6.15 I would like to reset to the original setting	27
Chapter 7 DIP switch setting.....	28
7.1 SYSTEM SWITCH	28
7.2 IR SELECT	28
Chapter 8 Troubleshooting.....	29

Copyright Information

Copyrights © Lumens Digital Optics Inc. All rights reserved.

Lumens is a trademark that is currently being registered by Lumens Digital Optics Inc.

Copying, reproducing or transmitting this file is not allowed if a license is not provided by Lumens Digital Optics Inc. unless copying this file is for the purpose of backup after purchasing this product.

In order to keep improving the product, Lumens Digital Optics Inc. hereby reserves the right to make changes to product specifications without prior notice. The information in this file is subject to change without prior notice.

To fully explain or describe how this product should be used, this manual may refer to names of other products or companies without any intention of infringement.

Disclaimer of warranties: Lumens Digital Optics Inc. is neither responsible for any possible technological, editorial errors or omissions, nor responsible for any incidental or related damages arising from providing this file, using, or operating this product.

Chapter 1 Safety Instructions

Always follow these safety instructions when setting up and using the product:

1 Operation

- 1.1 Please use the product in the recommended operating environment.
- 1.2 Do not place the product in tilted position.
- 1.3 Do not place the product on an unstable trolley, stand or table.
- 1.4 Do not use this product near water or source of heat.
- 1.5 Use attachments only as recommended.
- 1.6 Use the type of power source indicated on the product. If you are not sure of the type of power available, consult your distributor or local electricity company for advice.
- 1.7 Always take the following precautions when handling the plug. Failure to do so may result in sparks or fire:
 - Ensure the plug is free of dust before inserting it into a socket.
 - Ensure that the plug is inserted into the socket securely.
- 1.8 Do not overload wall sockets, extension cords or multi-way plug boards to avoid potential risks.
- 1.9 Do not block the slots and openings in the case of this product. They provide ventilation and prevent the product from overheating.
- 1.10 Except as specifically instructed in this User Manual, do not attempt to operate this product by yourself. Opening or removing covers may expose you to dangerous voltages and other hazards. Refer all servicing to licensed service personnel.
- 1.11 Unplug the product from the wall outlet and refer servicing to licensed service personnel when the following situations happen:
 - If the power cords are damaged or frayed.
 - If liquid is spilled into the Product or the Product has been exposed to rain or water.

2 Installation

- 2.1 For security considerations, please make sure the standard hanging rack you bought is in line with UL or CE safety approbations and installed by technician personnel approved by agents.

3 Storage

- 3.1 Do not place the Product where the cord can be stepped on as this may result in fraying or damage to the lead or the plug.
- 3.2 Never push objects of any kind through cabinet slots. Never allow liquid of any kind to spill into the Product.
- 3.3 Unplug this product during thunderstorms or if it is not going to be used for an extended period.
- 3.4 Do not place this product or accessories on top of vibrating equipment or heated objects.

4 Cleaning

4.1 Unplug all the cables before cleaning. Use a damp cloth for cleaning. Do not use liquid or aerosol cleaners.





5 Remote control (if the accessories are equipped with remote control)

5.1 Using an incorrect battery type in the remote control may result in breakdown. Follow local instructions on how to dispose of used batteries.

■ Precautions

Warning: To reduce the risk of fire or electric shock, do not expose this appliance to rain or moisture.

If the HD camera will not be used for an extended time, unplug it from the power socket.

	<p>Note</p> <p>Risk of Electric Shock Please do not open it by yourself.</p>		
<p>Caution: To reduce the risk of electric shock, do not remove cover (or back). No user-serviceable parts inside. Refer servicing to licensed service personnel.</p>			
	<p>This symbol indicates that this equipment may contain dangerous voltage which could cause electric shock.</p>		<p>This symbol indicates that there are important operating and maintenance instructions in this User Manual with this unit.</p>

■ FCC Warning

This HD camera has been tested and found to comply with the limits for a Class A digital device, pursuant to Article 15-J of FCC Rules. These limits are designed to provide reasonable protection against harmful interference in a commercial installation.

This digital apparatus does not exceed the Class A limits for radio noise emissions from digital apparatus as set out in the interference-causing equipment standard entitled "Digital Apparatus," ICES-003 of Industry Canada.

Cet appareil numérique respecte les limites de bruits radioélectriques applicables aux appareils numériques de Classe A prescrites dans la norme sur le matériel brouilleur: "Appareils Numériques," NMB-003 édictée par l'Industrie.

■ EN55032 (CE Radiation) Warning

Operation of this equipment in a residential environment could cause radio interference.

Chapter 2 Package Contents

VC-B30U



Instruction for
installation



Remote Control



Power Cord

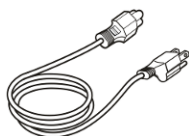

Appearance may vary
depending on
country/region

Power Adapter

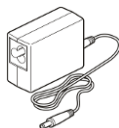

USB cable (USB 3.0)

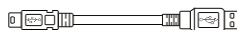

HDMI cable



Chapter 3 Product Overview

3.1 Overview

Front View



Back View

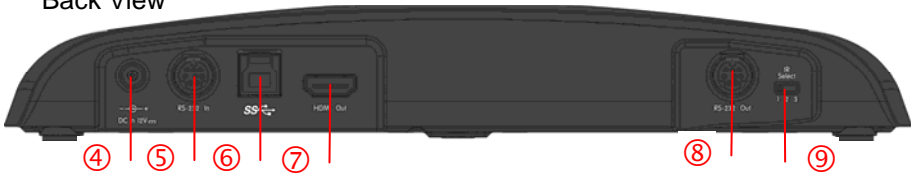

1. Camera Lens	2. Power LED Indicator
3. Standby LED Indicator	4. Power Input
5. RS232 IN	6. USB 3.0 Port
7. HDMI Output	8. RS232 Output
9. IR Select DIP Switch	

3.2 Description of LED indicator

3.2.1 Power:

3.2.1.1 No Light: Power off

3.2.1.2 Green light: In use

3.2.2 Standby:

3.2.2.1 No Light: Power on

3.2.2.2 Orange: Startup in progress or in standby mode

3.2.2.3 Flickering orange: Power off in progress

3.3 System Requirements

1. Windows System: Windows 7 or later
2. Chrome system
3. MAC System: Mac OS X (10.8 and above)

<Remark> When connecting to MAC, please refer to [Chapter 7 DIP Switch Setting](#), to modify DIP Switch

Chapter 4 Instruction for installation

4.1 Preparation before installation

Installation and connection of HD camera requires special skills. To install by yourself, please follow necessary steps, ensure steady and tight installation of the device, and pay attention to your safety to avoid any accident.

4.1.1 Ensure the safety of the installation environment. Please do not install the device on unstable ceiling or in a place where the device is in danger of falling to avoid any accident.

4.1.2 Please check whether accessories in the box are complete or not. Please contact the supplier for any shortage, and make sure to keep the accessories in the box intact.

4.1.3 Please choose a proper place for installation of camera in advance. Please determine an installation place according to the following requirements

4.1.1.1 Confirm the position for the object to be captured.

4.1.1.2 Confirm whether the camera is set at a proper distance from other light sources.

4.2 Instruction for installation

4.2.1 I would like to install camera on the desk

4.2.1.1 Precautions for installation

- ◆ Please install the machine on a flat desk
- ◆ Do not grab the camera head by hand when handling the device
- ◆ Do not rotate the camera head by hand. Improper rotation may result in breakdown of the camera

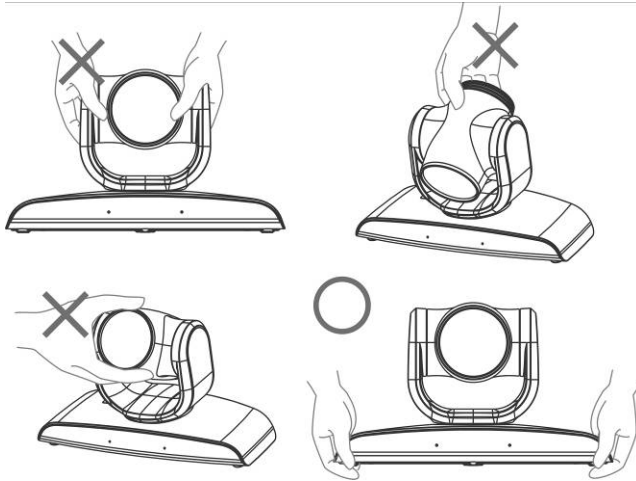

4.2.1.2 Installation steps

1. Install the camera on the wall with VC-AC03

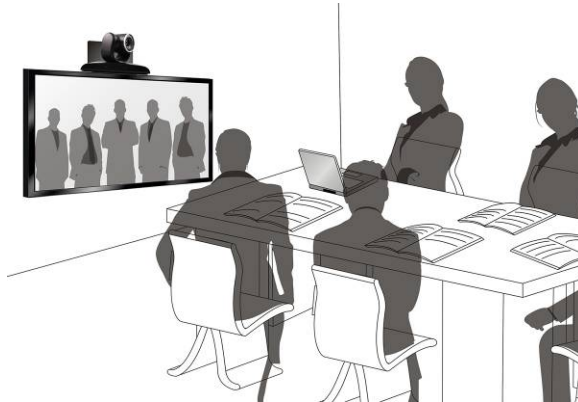

<Remark> For the installation of VC-AC03, please refer to [VC-AC03 Quick Installation Guide](#)

4.2.1.3 Camera Size

Length x Width x Height: 267.69 x 123 x 155.60 mm

Weight : 1.3 Kg

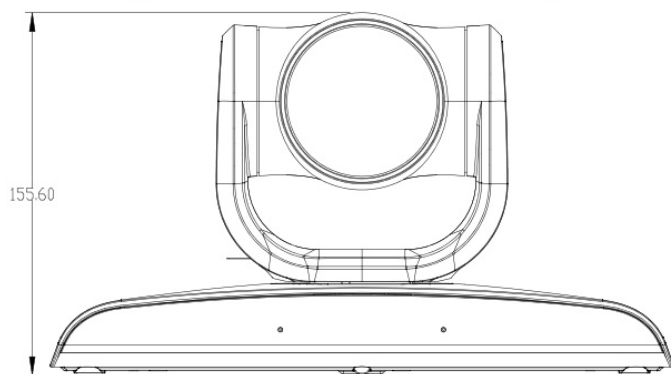
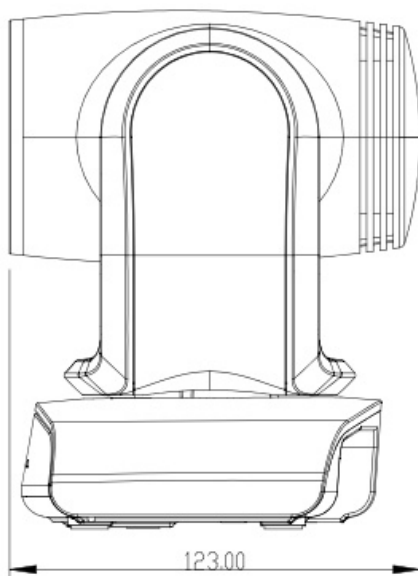
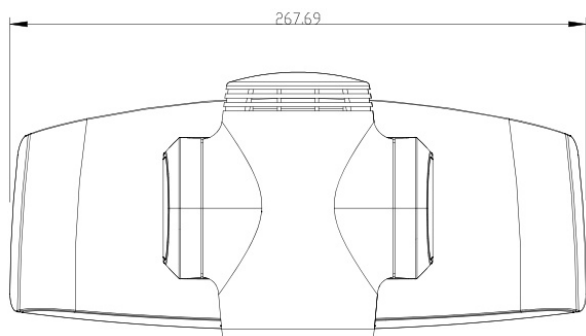

4.2.1.4 Precautions for installation

1. Before installation, please confirm the orientation of the machine relative to the object to be captured
2. It is recommended that the machine should be set at a distance of more than 1 meter away from the object to be captured. Please adjust for a best distance according to the magnification of the lens

4.3 Connecting the device

4.3.1 Video Conference - Connecting to PC

<Remark> Camera System Switch should be set to USB Mode

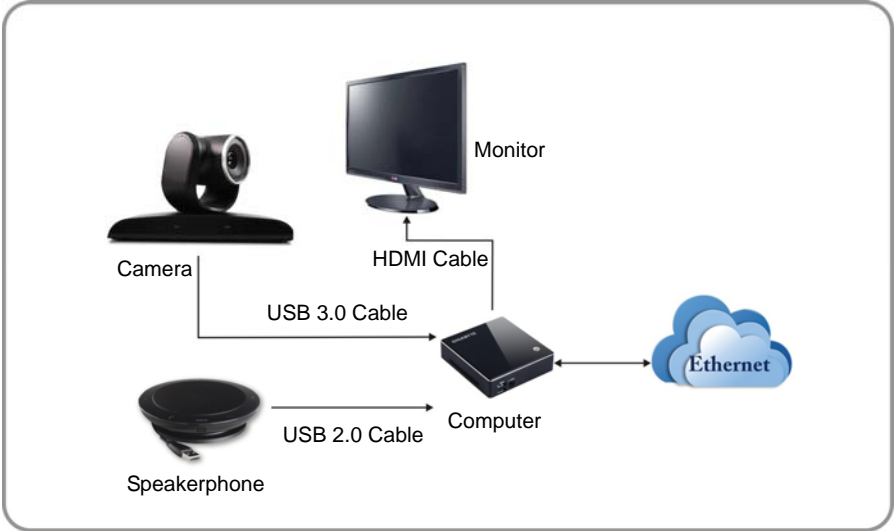

4.3.2 Video Conference - connecting to dual monitor

<Remark> Camera System Switch should be set to USB Mode

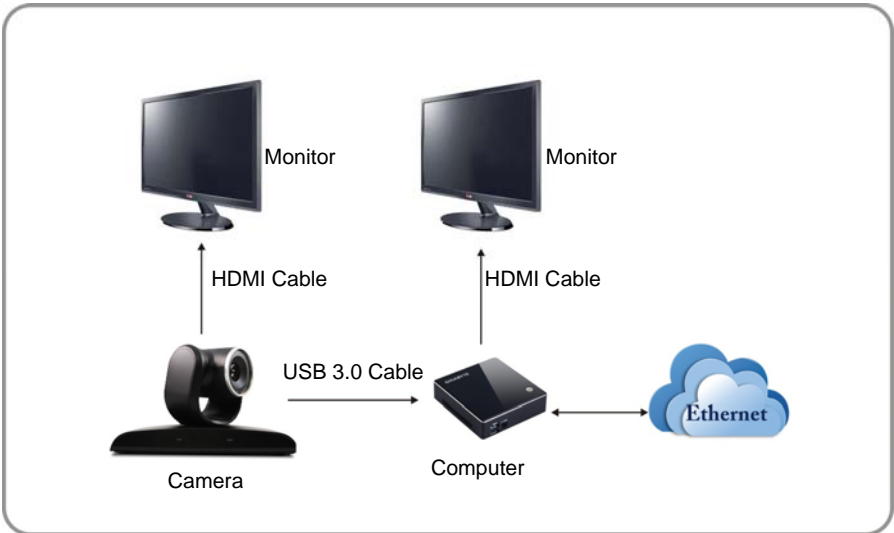

4.3.3 Video Conference - Connecting to the conference host

<Remark> Camera System Switch should be set to HDMI Mode

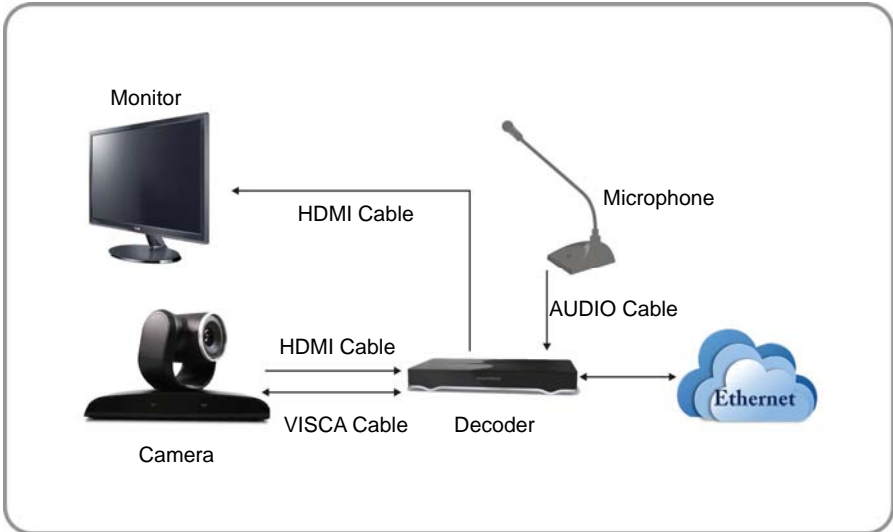

4.3.4 Connect Multiple VC-B30U Sets Through VISCA

<Remark> Camera System Switch should be set to HDMI Mode

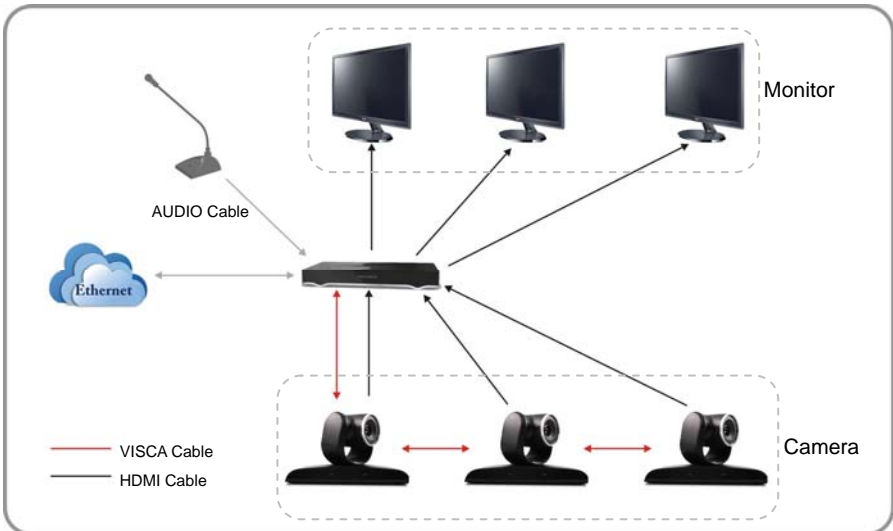

<Remark> With RS-232 in/out, at most 7 VCs can be connected.

4.3.5 IR Out

IR Out includes IR Right and IR Left, use VISCA command to switch:

1. IR right and IR left ON
2. IR left OFF, IR right ON
3. IR left ON, IR right OFF
4. NA (no signal from IR receiver.)

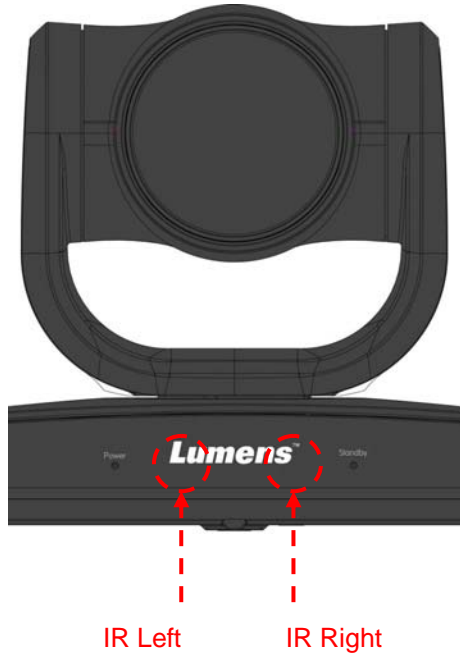

Chapter 5 Setting Menu Description

5.1 Functions of remote control

<Remark> The below functions are listed alphabetically.

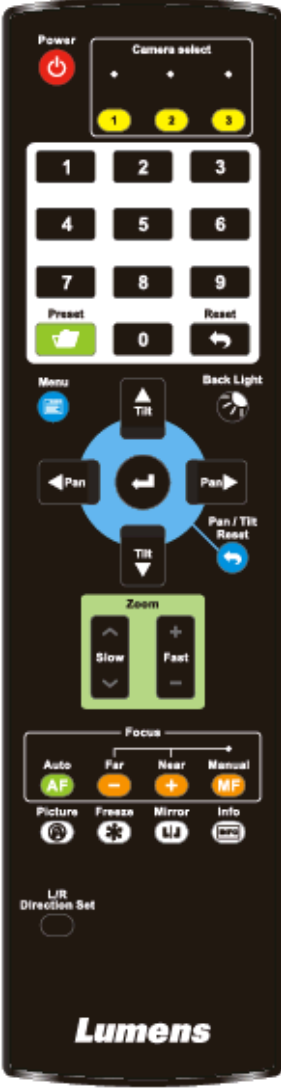
	Item	Description
	◀, ▶, ▲, ▼	Move the lens
	Back Light	Turn on/off back light compensation
	Camera select	Choose camera 1 ~ 3
	Focus-Manual / Far/Near	Turn on manual focus to adjust the focal length
	Focus-Auto	Auto Focus
	Freeze	Freeze the screen
	Home-Enter	Go back to the main page / Execute
	Info	Status information
	L/R Direction Set	L/R Direction / Normal
	Menu	Display OSD menu
	Mirror	Rotate the image (OFF / Mirror / Flip / Rotate)
	Pan/Tilt Reset	Clear the Pan / Tilt setting
	Picture	Switch image effect (OFF / Neg / B&W)
	Power	Power Switch
	Preset	Appoint an ID (0 ~ 9) to save the current position data
	Reset	Appoint an ID (0 ~ 9) to delete the current position data
	Zoom-Fast	Adjust image size
	Zoom-Slow	Fine-tune image size

5.2 Setting Menu

<Remark> Press [**Menu**] on the **remote control** to enter the setting menu; the **bold underlined** values in the following table are defaults.

1st Level Major Items	2nd Level Minor Items	3rd Level Adjustment Values		Function Descriptions	
Exposure	Mode	1. <u>Full Auto</u> 2. Smooth Auto 3. Shutter Pri 4. Iris Pri 5. Manual 6. White Board		Exposure mode setting	
	Exposure Comp.	<u>On</u> / Off		AE Level	
	Exposure Comp. Level	-6~ <u>C</u> ~4		The value can be adjusted only after Exposure Comp. is activated	
	Spot Light	On / <u>Off</u>		The value can be adjusted when the mode is set to Full Auto or Shutter Pri	
	Spot Light Position	X(0~8)Y(0~6)		The value can be adjusted only after Spot Light is activated	
	Shutter Pri		60/30 mode	50/25 mode	Shutter priority setting
			1/10000	1/10000	
			1/5000	1/5000	
			1/3000	1/3000	
1/2500			1/2500		
1/2000			1/1750		
1/1500			1/1250		
1/1000			1/1000		
1/725			1/600		
1/500	1/425				

		1/350	1/300	
		1/250	1/215	
		1/180	1/150	
		1/120	1/120	
		1/100	1/100	
		1/90	1/75	
		<u>1/60</u>	<u>1/50</u>	
		1/30	1/25	
		1/15	1/12	
		1/8	1/6	
		1/4	1/3	
		1/2	1/2	
		1/1	1/1	
	Iris Pri	<ol style="list-style-type: none"> 1. <u>F1.8</u> 2. F2.5 3. F3.6 4. F5.1 5. F7.2 6. F10 7. F14 8. F20 		Iris setting

	Manual Gain	<ol style="list-style-type: none"> 1. 0dB 2. 2 dB 3. 4 dB 4. 6 dB 5. 8 dB 6. 10 dB 7. 12 dB 8. 14 dB 9. 16 dB 10. 18 dB 11. 20 dB 12. 22 dB 13. 24 dB 14. 26 dB 15. 28 dB 16. 30 dB 		Manually set the gain																																
	Manual Speed	<table border="1" style="width: 100%; border-collapse: collapse;"> <tr> <td style="text-align: center;">60/30 mode</td> <td style="text-align: center;">50/25 mode</td> </tr> <tr><td style="text-align: center;">1/10000</td><td style="text-align: center;">1/10000</td></tr> <tr><td style="text-align: center;">1/5000</td><td style="text-align: center;">1/5000</td></tr> <tr><td style="text-align: center;">1/3000</td><td style="text-align: center;">1/3000</td></tr> <tr><td style="text-align: center;">1/2500</td><td style="text-align: center;">1/2500</td></tr> <tr><td style="text-align: center;">1/2000</td><td style="text-align: center;">1/1750</td></tr> <tr><td style="text-align: center;">1/1500</td><td style="text-align: center;">1/1250</td></tr> <tr><td style="text-align: center;">1/1000</td><td style="text-align: center;">1/1000</td></tr> <tr><td style="text-align: center;">1/725</td><td style="text-align: center;">1/600</td></tr> <tr><td style="text-align: center;">1/500</td><td style="text-align: center;">1/425</td></tr> <tr><td style="text-align: center;">1/350</td><td style="text-align: center;">1/300</td></tr> <tr><td style="text-align: center;">1/250</td><td style="text-align: center;">1/215</td></tr> <tr><td style="text-align: center;">1/180</td><td style="text-align: center;">1/150</td></tr> <tr><td style="text-align: center;">1/120</td><td style="text-align: center;">1/120</td></tr> <tr><td style="text-align: center;">1/100</td><td style="text-align: center;">1/100</td></tr> <tr><td style="text-align: center;">1/90</td><td style="text-align: center;">1/75</td></tr> </table>		60/30 mode	50/25 mode	1/10000	1/10000	1/5000	1/5000	1/3000	1/3000	1/2500	1/2500	1/2000	1/1750	1/1500	1/1250	1/1000	1/1000	1/725	1/600	1/500	1/425	1/350	1/300	1/250	1/215	1/180	1/150	1/120	1/120	1/100	1/100	1/90	1/75	Manually set the shutter
60/30 mode	50/25 mode																																			
1/10000	1/10000																																			
1/5000	1/5000																																			
1/3000	1/3000																																			
1/2500	1/2500																																			
1/2000	1/1750																																			
1/1500	1/1250																																			
1/1000	1/1000																																			
1/725	1/600																																			
1/500	1/425																																			
1/350	1/300																																			
1/250	1/215																																			
1/180	1/150																																			
1/120	1/120																																			
1/100	1/100																																			
1/90	1/75																																			

		<u>1/60</u>	<u>1/50</u>	
		1/30	1/25	
		1/15	1/12	
		1/8	1/6	
		1/4	1/3	
		1/2	1/2	
		1/1	1/1	
	Manual Iris	<ol style="list-style-type: none"> 1. <u>F1.8</u> 2. F2.5 3. F3.6 4. F5.1 5. F7.2 6. F10 7. F14 8. F20 		Manually set the iris
	Gain Limit	<ol style="list-style-type: none"> 1. 8 dB 2. 10 dB 3. 12 dB 4. 14 dB 5. 16 dB 6. 18 dB 7. 20 dB 8. 22 dB 9. 24 dB 10. 26 dB 11. 28 dB 12. <u>30dB</u> 		Max. limit value of electron gain
	WDR	<ol style="list-style-type: none"> 1. <u>Off</u> 2. 1 3. 2 4. 3 5. 4 6. 5 		WDR settings

White Balance	Mode	<ol style="list-style-type: none"> Auto Indoor Outdoor One Push WB ATW Manual Sodium Lamp 3000K 4300K 5000K 6500K 8300K WideAuto 	Select the color temperature mode <ol style="list-style-type: none"> 4000k ~ 7000k 3200k 5800k 1700k ~ 10000k 1700k ~ 10000k Custom 2800k 3000K 4300K 5000K 6500K 8000K 3000k ~ 7000k
	One Push Trigger	ENTER	One push trigger
	Manual R Gain	0~ C ~60	Adjustable when the white balance mode is set to Manual
	Manual B Gain	0~ C ~60	Adjustable when the white balance mode is set to Manual
Picture	Picture effect	<ol style="list-style-type: none"> Off Neg B & W 	Set the picture effect
	Sharpness	1~ A ~16	Adjust the sharpness of the image
	2D NR	<ol style="list-style-type: none"> Auto Off 1 2 3 4 5 	2D noise reduction settings

	3D NR	<ol style="list-style-type: none"> Off <u>Low</u> Typ Max Auto 	3D dynamic noise reduction settings
	Saturation	0~ <u>A</u> ~25	
	Hue	0~ <u>A</u> ~14	
	Gamma	0~ <u>A</u> ~3	
	Skin Tone	1~ <u>A</u> ~5	
	Brightness	0~ <u>A</u> ~14	
	Contrast	0~ <u>A</u> ~14	Contrast adjustment
	Black Level	<ol style="list-style-type: none"> <u>Off</u> Type 1 Type 2 Type 3 	Shadow details and translucency adjustment
Pan Tilt Zoom	Pan/Tilt Limit	On / <u>Off</u>	Turn on/off the angle limit setting
	Pan Right Limit	0~ <u>100</u>	Limit the right angle
	Pan Left Limit	<u>-100</u> ~0	Limit the left angle
	Tilt UP Limit	0~ <u>30</u>	Limit the upward angle
	Tilt Down Limit	<u>-30</u> ~0	Limit the downward angle
	D-Zoom Limit	<u>x1</u> ~x12	Limit the D-zoom multiple
D-Effect	Mirror	<ol style="list-style-type: none"> <u>Off</u> Mirror Flip Mirror + Flip 	Set the mode at which the image is turned
Auto Focus	AF Sensitivity	<ol style="list-style-type: none"> Low <u>Middle</u> High 	Select the AF triggering speed. The higher the speed is, the faster AF is triggered

	AF Frame	<u>Full Area</u> /Center Area	AF frame setting, when central area was set as AF frame, focusing will be on the center of the screen. When Full Frame was set as AF frame, focusing will be calculated based on the full screen
System	Prompt	On / <u>Off</u>	Turn on/off the prompt information on the display
	Motionless Preset	On / <u>Off</u>	When the function is enabled, the screen will Freeze when Preset is executed. Freeze will be released after Preset is completed. Supports HMDI output
	IR Receive	<u>On</u> / Off	Turn on/off the infrared reception
	Language	<u>English</u> / Chinese	Language
	Factory Reset	On / <u>Off</u>	Resume the factory default setting
Status			Display the current setting status

Chapter 6 Descriptions of Major Functions

6.1 I would like to switch camera

1. Press [**Camera 1 ~ 3**] on the **remote control** to select VC-B30U.
 - **Camera 1 ~ 3 is selected with IR SELECT.**

6.2 I would like to control the camera

The VC-B30U can be controlled using the “USB PTZ Camera Controller” software or the **VS-K20 Compact Camera Controller**.

- The USB PTZ Camera Controller software can be downloaded from the Lumens website. Refer to the [USB PTZ Camera Controller Manual](#) for more details.
- The **VS-K20 Compact Camera Controller can be purchased separately. Please refer to the [VS-K20 User Manual](#) for more details.**

6.3 I would like to save the current lens position data

1. Hold [**Preset + ID**] on the **remote control** to save the current position data.
 - **ID shall be a digit [0 ~ 9].**
 - **Use VISCA Command to store position data to [0 ~ 127]**

6.4 I would like to clear the saved position data

1. Hold [**Reset + ID**] on the **remote control** to clear the given position data.
 - **ID shall be a digit [0 ~ 9].**
 - **Use VISCA command to clear position data stored in [0 ~ 127]**

6.5 I would like to turn on the back light compensation function

1. Press **[Back Light]** on the **remote control** to turn on or turn off the back light compensation

6.6 I would like to adjust the shooting angle of the lens

1. Press **[Tilt ▲]** or **[Tilt ▼]** on the **remote control** to adjust the angle upward or downward.
2. Press **[Pan ►]** or **[Pan ◀]** on the **remote control** to adjust the angle to right or left.
3. Press **[Pan - Tilt Reset]** on the **remote control** to reset the angle to the center point.

6.7 I would like to zoom in/out images

6.7.1 Adjust image size

1. Press **[Fast +]** on the **remote control** to zoom in images.
2. Press **[Fast -]** on the **remote control** to zoom out images.

6.7.2 Fine-tune image size

1. Press **[Slow +]** on the **remote control** to zoom in images.
2. Press **[Slow -]** on the **remote control** to zoom out images.

6.8 I would like to adjust the focal length

6.8.1 Auto tune

1. Press **[AF]** on the **remote control** to adjust automatically.

6.8.2 Manual focus

1. Press **[MF]** on the **remote control** to turn on the manual focus function.
2. Press **Focus - [+]** or **Focus - [-]** to adjust.

6.9 I would like to adjust the AF speed

6.9.1 Adjust the AF Sensitivity

Triggering speed of focus. The higher the speed is, the faster focus is triggered

To shoot fast-moving objects, **AF Sensitivity** can be set to **[High]** or **[Medium]**, which is applicable to quick focus.

When the environment is too dark to enable auto focus or fixed objects have to be shot in different brightness, **AF Sensitivity** can be set to **[Low]**.

1. Press [MENU] to activate the setting menu.
2. Press [▶] or [◀] to select [Auto Focus].
3. Press [ENTER] to activate.
4. Press [▲] or [▼] to select [AF Sensitivity].
5. Press [ENTER] to activate.
6. Press [▶] or [◀] to select [High / Middle / Low].
7. Press [MENU] to exit.

6.9.2 Adjust the AF speed

The focus speed upon triggering **AF Sensitivity**

- **[Normal]** (default): Image flickering may not occur
- **[Fast]**: Fast focus speed

1. Press [MENU] to activate the setting menu.
2. Press [▶] or [◀] to select [Auto Focus].
3. Press [ENTER] to activate.
4. Press [▲] or [▼] to select [AF speed].
5. Press [ENTER] to activate.
6. Press [▶] or [◀] to select [Fast / Normal].
7. Press [MENU] to exit.

6.10 I would like to set the image mode

1. Press [**Picture**] on the **remote control** to switch [Off / Neg / B&W].

6.11 I would like to freeze images

1. Press [**Freeze**] on the **remote control** to freeze the current image on the display.

6.12 I would like to rotate the image

1. Press [**Mirror**] on the **remote control** to switch [Off / Mirror / Flip / Mirror + Flip].

6.13 I would like to change the camera direction

1. Press [**L/R Direction Set**] on the **remote control** to switch [L/R Direction / Off / Normal].

6.14 I would like to display the current status

1. Press [**Info**] on the **remote control** to display the current status information.

6.15 I would like to reset to the original setting

1. Press [**MENU**] to activate the setting menu.
2. Press [**▶**] or [**◀**] to select [**System**].
3. Press [**ENTER**] to activate.
4. Press [**▲**] or [**▼**] to select [**Factory Reset**].
5. Press [**ENTER**] to activate.
6. Press [**▶**] or [**◀**] to select [**On**].
7. Press [**ENTER**] to execute.

Chapter 7 DIP switch setting

<Note> Please turn off the machine before changing DIP switch setting.



7.1 SYSTEM SWITCH

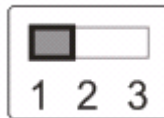

Setting	Function Descriptions
DIP 1	HDMI / USB Mode OFF:USB Mode / ON:HDMI Mode
DIP 2	Output Resolution OFF:1080P / ON:720P
DIP 3	Power Frequency OFF:60Hz / ON:50Hz
DIP 4	Bulk / ISO Mode OFF: Bulk Mode / ON:ISO Mode

7.2 IR SELECT



ID	Setting
1	
2	
3	

Chapter 8 Troubleshooting

This chapter describes problems you may encounter while using VC-B30U. If you have questions, please refer to related chapters and follow all the suggested solutions. If the problem still occurred, please contact your distributor or the service center.

No.	Problems	Solutions
1.	Boot without power signal	1. Make sure you have plugged in the power cord.
2.	There is no image output from VC-B30U	1. Check the power. 2. Make sure the display supports the output resolution; in general, the resolution is 1080p60/1080i60/720p60. 3. Replace the cables and make sure they are not faulty.
3.	VC-B30U cannot be operated by remote control	1. Please confirm that VC-B30U has been connected to the computer, and launch video software. 2. Please prevent VC-B30U from direct sunshine. 3. Make sure the energy-saving bulb and the IR touch screen are as far as possible in order to avoid interference. 4. When several VC-B30U are connected in the same area, the operation of two remote controls at the same time may result in signal interference. It is recommended to use one remote control only.
4.	Windows vista/Windows 7 do not support YUV2 1920 x 1080 resolution @60 fps	1. YUV2 1920 x 1080@60 fps is supported by USB 3.0 only. Please connect to USB 3.0 Host 2. Please adjust image resolution to 720P when YUV2 is not supported after connecting to USB 3.0 Host.
5.	When connected to the MAC computer, the video screen flicker or freeze	Please confirm that DIP Switch-DIP4 at the base of the camera is switched to "ON" when using Mac OS X 10.10 or earlier.