

Panasonic®

Operating Instructions

Memory Card Camera-Recorder

Model No. **AG-UX180**

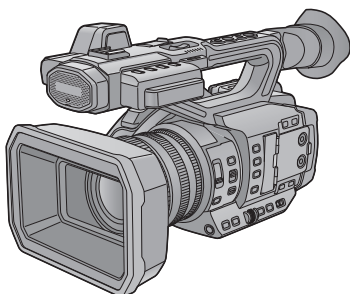

Please read these instructions carefully before using this product, and save this manual for future use.

AVCHD™
Progressive

HDMI

SD™
XC **U3**
I

DOLBY
DIGITAL

LEICA
DICOMAR

EJ **EN**
F1116YF0

ENGLISH
DVQP1165ZA

Български	Посетете следния уебсайт относно информация за безопасността и важни уведомления за продукта.
Hrvatski	Za sigurnosne informacije i važne obavijesti o proizvodu posjetite sljedeću internetsku stranicu.
Čeština	Na následujícím webu najdete bezpečnostní informace a důležité poznámky k tomuto produktu.
Dansk	Besøg følgende webside for sikkerhedsinformation og vigtige bemærkninger vedrørende produktet.
Nederlands	Ga naar de volgende website voor veiligheidsinformatie en belangrijke meldingen over het product.
Eesti	Toodet puudutava ohutusteabe ja oluliste märkuste saamiseks külastage järgmist veebilehte.
Suomi	Käy seuraavalla verkkosivulla saadaksesi turvallisuustietoja ja tärkeitä tietoja liittyen laitteeseen.
Ελληνικά	Για πληροφορίες σχετικά με θέματα ασφάλειας και σημαντικές ειδοποιήσεις που αφορούν το προϊόν σας, επισκεφτείτε τον ιστότοπο που ακολουθεί.
Magyar	A termékkel kapcsolatos biztonsági információkért és fontos értesítésekért látogasson el az alábbi weboldala.
Latviešu	Lai iegūtu informāciju par drošību un skatītu svarīgus paziņojumus par šo produktu, apmeklējiet tālāk norādīto tīmekļa vietni.
Lietuvių	Jeji reikia saugos informacijos ir svarbių pranešimų apie gaminį, apsilankykite toliau nurodytoje svetainėje.
Polski	Informacje o bezpieczeństwie i ważne informacje o produkcie znajdując się w poniższej witrynie internetowej.
Português	Consulte o seguinte website para as informações de segurança e importantes notificações sobre o produto.
Română	Vizitați următoarea pagină web pentru informații de securitate și notificări importante cu privire la produs.
Slovensky	Pre bezpečnostné informácie a dôležité oznámenia súvisiace s produktom navštívte túto webovú stránku.
Slovenščina	Za varnostne informacije in pomembna obvestila v zvezi z izdelkom obiščite naslednje spletno mesto.
Svenska	Besök följande webbplats för säkerhetsinformation och viktiga meddelanden om produkten.

<http://pro-av.panasonic.net/en/manual/index.html>

Information for Your Safety

For the AC mains plug of three pins



■ Caution for AC mains lead

For your safety, please read the following text carefully.

This appliance is supplied with a moulded three pin mains plug for your safety and convenience.

A 5-ampere fuse is fitted in this plug.

Should the fuse need to be replaced please ensure that the replacement fuse has a rating of 5-ampere and that it is approved by ASTA or BSI to BS1362.

Check for the ASTA mark  or the BSI mark  on the body of the fuse.

If the plug contains a removable fuse cover you must ensure that it is refitted when the fuse is replaced.

If you lose the fuse cover the plug must not be used until a replacement cover is obtained.

A replacement fuse cover can be purchased from your local dealer.

Before use

Remove the connector cover.

How to replace the fuse

The location of the fuse differ according to the type of AC mains plug (figures A and B). Confirm the AC mains plug fitted and follow the instructions below.

Illustrations may differ from actual AC mains plug.

1. Open the fuse cover with a screwdriver.

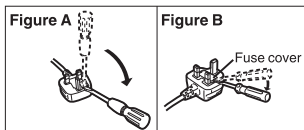

2. Replace the fuse and close or attach the fuse cover.

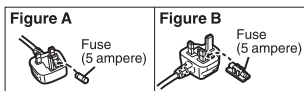

WARNING:

To reduce the risk of fire, electric shock or product damage,

- Do not expose this unit to rain, moisture, dripping or splashing.
- Do not place objects filled with liquids, such as vases, on this unit.
- Use only the recommended accessories.
- Do not remove covers.
- Do not repair this unit by yourself. Refer servicing to qualified service personnel.

CAUTION!

To reduce the risk of fire, electric shock or product damage,

- Do not install or place this unit in a bookcase, built-in cabinet or in another confined space. Ensure this unit is well ventilated.
- Do not obstruct this unit's ventilation openings with newspapers, tablecloths, curtains, and similar items.
- Do not place sources of naked flames, such as lighted candles, on this unit.

The mains plug is the disconnecting device. Install this unit so that the mains plug can be unplugged from the socket outlet immediately.

This unit is intended for use in moderate climates. (AG-UX180EJ)

This unit is intended for use in moderate and tropical climates. (AG-UX180EN)

■ Concerning the battery

Warning

Risk of fire, explosion and burns. Do not disassemble, heat above 60 °C or incinerate.

CAUTION

- Danger of explosion if battery is incorrectly replaced. Replace only with the type recommended by the manufacturer.
- When disposing of the batteries, please contact your local authorities or dealer and ask for the correct method of disposal.

For Europe only

■ EMC Electric and magnetic compatibility

This symbol (CE) is located on the rating plate.

■ Product identification marking

Product	Location
Memory Card Camera-Recorder	Bottom
Battery charger	Bottom
AC adaptor	Bottom

■ Disposal of Old Equipment and Batteries Only for European Union and countries with recycling systems



These symbols on the products, packaging, and/or accompanying documents mean that used electrical and electronic products and batteries must not be mixed with general household waste.

For proper treatment, recovery and recycling of old products and used batteries, please take them to applicable collection points in accordance with your national legislation.

By disposing of them correctly, you will help to save valuable resources and prevent any potential negative effects on human health and the environment. For more information about collection and recycling, please contact your local municipality.

Penalties may be applicable for incorrect disposal of this waste, in accordance with national legislation.



Note for the battery symbol (bottom symbol):

This symbol might be used in combination with a chemical symbol. In this case it complies with the requirement set by the

Directive for the chemical involved.

To remove the battery

Main Power Battery (Lithium ion Battery) (Refer to page 26 for the detail.)

While pressing the battery release button, remove the battery.

Back-up Battery (Lithium Battery)

- For the removal of the battery for disposal at the end of its service life, please consult your dealer.

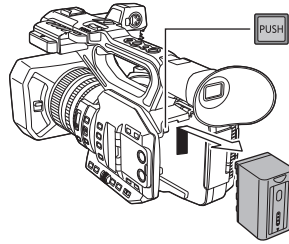

AEEE Yönetmeliğine Uygundur.
AEEE Complies with Directive of Turkey.

Note regarding the Power Management function specified under COMMISSION REGULATION (EC) No 1275/2008 implementing Directive 2009/125/EC of the European Parliament and of the Council.

This device is designed and manufactured for use at a broadcasting station and/or in a similar environment.

This device is not equipped with a Power Management function or the Power Management function is set to OFF as it will prevent the device from fulfilling its intended purpose for the reasons below.

1. If the device is a Studio Camera, a Weather Camera, a Mixer or other processor: A Power Management function may cause the device to suddenly stop during recording or while On Air.
2. If the device is a Studio Monitor: A Power Management function may cause video for the confirmation of whether a signal is normal, or whether the signal has been lost, to be unviewable.
3. If the device is a Camera Recorder: A professional camera recorder must be able to start quickly at any time, but a Power Management function will cause an increase in the time taken to resume from Stand-by mode.

■ Cautions for use

About this unit

The unit and the SD card become warm during use. This is not a malfunction.

Keep this unit as far away as possible from electromagnetic equipment (such as microwave ovens, TVs, video games etc.).

- If you use this unit on top of or near a TV, the pictures and/or sound on this unit may be disrupted by electromagnetic wave radiation.
- Do not use this unit near cell phones because doing so may result in noise adversely affecting the pictures and/or sound.
- Recorded data may be damaged, or pictures may be distorted, by strong magnetic fields created by speakers or large motors.
- Electromagnetic wave radiation generated by microprocessors may adversely affect this unit, disturbing the pictures and/or sound.
- If this unit is adversely affected by electromagnetic equipment and stops functioning properly, turn this unit off and remove the battery or disconnect AC adaptor. Then reinsert the battery or reconnect AC adaptor and turn this unit on.

Do not use this unit near radio transmitters or high-voltage lines.

- If you record near radio transmitters or high-voltage lines, the recorded pictures and/or sound may be adversely affected.

About connecting to a PC

- A USB 3.0 cable is not supplied with this unit. Use a commercially-available double-shielded USB 3.0 cable with a ferrite core. If possible, we recommend using a cable with a length of 1.5 m or less.

About using a headphone

- Excessive sound pressure from earphones and headphones can cause hearing loss.
- Listening at full volume for long periods may damage the user's ears.

Make sure to use the supplied cords and cables. If you use optional accessories, use the cords and the cables supplied with them. Do not extend the cords and the cables.

Do not spray insecticides or volatile chemicals onto the unit.

- If the unit is sprayed with such chemicals, its body may be marred and the surface finish may peel off.
- Do not leave rubber or plastic products in contact with the unit for a long time.

When you use the unit in a sandy or dusty place such as a beach, do not let sand or fine dust get into the body and terminals of the unit. Also, keep the unit away from sea water.

- Sand or dust may damage the unit. (Care should be taken when inserting and removing a card.)
- If sea water splashes onto the unit, wipe off the water with a well wrung cloth. Then wipe the unit again with a dry cloth.

When carrying the unit, do not drop or bump it.

- A strong impact can break the unit's casing, causing it to malfunction.
- When carrying this unit, please hold the handle, hand strap or shoulder strap firmly and treat it with care.

Cleaning

- Before cleaning, detach the battery or pull the AC cable from the AC outlet, and then wipe the unit with a soft, dry cloth.
- If the unit is very dirty, dip a cloth in water and squeeze firmly, and then wipe the unit with the damp cloth. Next, dry the unit with a dry cloth.

- Use of benzine, paint thinner, alcohol, or dishwashing liquid may alter the camera body or peel the surface finish. Do not use these solvents.
- When using a chemical dust cloth, follow the instructions that came with the cloth.

When you are not going to use the unit for an extended time

- When storing the unit, it is recommended that you place a desiccant (silica gel) in with it.

Do not lift up this unit by the handle with the tripod still attached

- When the tripod is attached, its weight will also affect the unit's handle, possibly causing the handle to break and hurting the user.
- To carry the unit while the tripod is attached, take hold of the tripod.

Do not swing the unit around, shake it by, or allow it hang from the handle

- Do not jar, swing, or shake the unit by its handle. Any strong jolt to the handle may damage the unit or result in personal injury.

Do not allow the cord to drag on the ground or pull a connected cord along the passage

- The cord will be damaged, causing fire or electrical shock, when the cord gets caught by the feet, excite will also cause personal injury.

When this unit is turned on, do not use it in direct contact with the skin for a long period of time.

- When using this unit for a long period of time, use a support such as a tripod. Low temperature burns may result if any high temperature part of this unit or hot air from the ventilation openings on the front side of the hand strap of this unit is in direct contact with the skin for a long period of time.

About the battery

The battery used in this unit is a rechargeable lithium-ion battery. It is susceptible to humidity and temperature and the effect increases the more the temperature rises or falls. In cold areas, the full charge indication may not appear or the low battery indication may appear about 5 minutes after starting use. At high temperatures, the protection function may be triggered, making it impossible to use the unit.

Be sure to detach the battery after use.

- If the battery is left attached, a minute amount of current continues to flow even if the unit is off. Keeping the unit in this state may result in over discharge of the battery. This may result in you not being able to use the battery even after it is charged.
- The battery should be stored in the vinyl bag so metal does not come into contact with the terminals.
- The battery should be stored in a cool place free from humidity, with as constant temperature as possible. (Recommended temperature: 15 °C to 25 °C, Recommended humidity: 40%RH to 60%RH)
- Extremely high temperatures or low temperatures will shorten the life of the battery.
- If the battery is kept in high-temperature, high-humidity, or oily-smoky places, the terminals may rust and cause malfunctions.
- To store the battery for a long period of time, we recommend you charge it once every year and store it again after you have completely used up the charged capacity.
- Dust and other matter attached to the battery terminals should be removed.

Prepare spare batteries when going out for recording.

- Prepare batteries enough to last for 3 to 4 times the period you are planning to record for. Cold places such as a ski resort can shorten recording time.

If you drop the battery accidentally, check to see if the terminals are damaged.

- When this unit or battery charger is attached with the terminal part in a deformed state, this unit or battery charger may be damaged.

Do not throw old battery into fire.

- Heating a battery or throwing it into a fire may result in an explosion.

If the operating time is very short even after the battery has been recharged, the battery has worn out. Please purchase a new battery.

About the AC adaptor/battery charger

- If the temperature of the battery is extremely high or extremely low, charging may take time or the battery may not be charged.
- If the CHARGE indicators keeps flashing in orange, make sure that the terminals of the battery or the battery charger are not exposed to dirt, foreign objects or dust, then reconnect them properly.
Disconnect the AC cable from the AC outlet when you remove dirt, foreign objects or dust on the terminals of the battery or the battery charger.
- If the battery's temperature is excessively high or excessively low, the CHARGE indicators will blink orange. Charging will start automatically when the battery reaches an acceptable temperature for charging.
- If the CHARGE indicators blinks orange when the battery's temperature is normal, the battery or the battery charger may be malfunctioning. In such cases, contact your dealer.
- If you use the AC adaptor or battery charger near a radio, radio reception may be disturbed. Keep the AC adaptor or battery charger 1 m or more away from the radio.
- When using the AC adaptor or battery charger, it may generate whirring sounds. However, this is normal.
- After use, be sure to disconnect the AC cable from the AC outlet. (If you leave this unit connected, the AC adaptor will consume approximately 0.1 W.)
- Always keep the electrodes of the AC adaptor, battery charger and battery clean.
- **Install the device near an AC outlet so that the power disconnection device (AC mains plug) can be accessed easily by hand.**

About the SD card

When disposing of or giving away the SD card, note that:

- Formatting and deletion of this unit or computer only changes the file management information and does not completely delete the data in the SD card.
- It is recommended that the main SD card is either physically destroyed or the SD card is physically formatted using this unit when disposing of or giving away the SD card.

- To physically format, connect this unit to the AC adaptor, select [OTHER FUNCTION] → [FORMAT MEDIA] → [SD CARD 1] or [SD CARD 2] from the menu, and touch [YES]. Press and hold recording start/stop button in the following screen for three seconds. Screen to delete the SD card data is displayed, so select [YES] and follow the instruction on the screen.

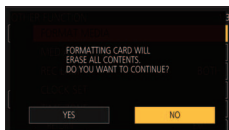

- The customer is responsible for the management of the data in the SD card.

LCD monitor/viewfinder

- When the LCD screen is dirty or condensation has occurred, please wipe it using a soft cloth such as a lens cloth.
- Do not touch the LCD monitor with your finger nails, or rub or press with strong force.
- It may become hard to see or hard to recognize the touch when the LCD protection sheet is affixed.
- When the unit has become very cold, for example due to storage in a cold area, its LCD monitor will be slightly darker than usual immediately after the unit is turned on. The normal brightness will be restored when the unit's internal temperature rises.

Extremely high precision technology is employed to produce the LCD Monitor screen. The result is more than 99.99% effective dots with a mere 0.01% of the dots inactive or always lit. However, this is not a malfunction and does not affect the recorded picture.

Extremely high precision technology is employed to produce the viewfinder screen. The result is more than 99.99% effective dots with a mere 0.01% of the dots inactive or always lit. However, this is not a malfunction and does not affect the recorded picture.

About personal information

When this unit is connected to iPad, the SSID, Password, and other personal information will be included in this unit. Setting a [NETWORK SETUP PASSWORD] is recommended to protect personal information. (→ 201)

Disclaimer

- Information including personal information may be altered or vanish due to erroneous operation, effect of static electricity, accident, malfunction, repair, or other handlings. Please note in advance that Panasonic is not liable in any way for any direct or indirect damage from the alteration or vanishing of information or personal information.

When requesting a repair, transferring to another party, or disposing.

- After making a copy of personal information, always delete information such as personal information and wireless LAN connection settings that you have saved within this unit with [NETWORK INITIAL SETTING]/[INITIAL SET]. (→ 199, 200)
- Remove the Memory Card from this unit when requesting a repair.
- Settings may return to factory default when this unit is repaired.
- Please contact the dealer where you purchased this unit or Panasonic if above operations are not possible due to malfunction.

When transferring to another party, or disposing of the Memory Card, please refer to “When disposing of or giving away the SD card, note that:”. (→ 7)

■ About the recording method for recording motion pictures

This unit can record motion pictures using three different recording methods, including MOV, MP4 and AVCHD*. (→ 43, 161)

* AVCHD Progressive (1080/60p, 1080/50p) supported.

MOV and MP4:

These recording methods are suitable for editing images. Audio is recorded in linear PCM.

- Those methods are not compatible with motion pictures recorded in AVCHD format.

- Those methods can record motion pictures in formats that support 4K. 4K motion pictures offer a resolution four times higher than that of full high-definition motion pictures.

AVCHD:

This recording method is suitable for playback on a high-definition compatible external monitor. Audio is recorded in Dolby® Digital.

■ Regarding system frequencies

You can change the system frequency (59.94 Hz/50.00 Hz) for this unit by using the menu. ([SYSTEM FREQ]: → 161, 198)

- You cannot store AVCHD scenes recorded with different system frequencies on the same SD card. If you have switched the system frequency, use another SD card.

■ Indemnity about recorded content

Panasonic does not accept any responsibility for damages directly or indirectly due to any type of problems that result in loss of recording or edited content, and does not guarantee any content if recording or editing does not work properly. Likewise, the above also applies in a case where any type of repair is made to the unit.

■ About Condensation (When the lens, the viewfinder or LCD Monitor is fogged up)

Condensation occurs when there is a change in temperature or humidity, such as when the unit is taken from outside or a cold room to a warm room. Please be careful, as it may cause the lens, the viewfinder or LCD monitor to become soiled, moldy, or damaged.

When taking the unit to a place which has a different temperature, if the unit is accustomed to the room temperature of the destination for about one hour, condensation can be prevented. (When the difference in temperature is severe, place the unit in a plastic bag or the like, remove air from the bag, and seal the bag.) When condensation has occurred, remove the battery and/or the AC adapter and leave the unit like that for about one hour. When the unit becomes accustomed to the surrounding temperature, fogginess will disappear naturally.

■ About security

Be careful about the possibility of theft or loss of the unit, and be careful not to leave the unit unattended. Please note that Panasonic does not accept any responsibility for the compromise, manipulation, and loss of information caused by these events.

■ Caution regarding laser beams



The lens may suffer damage if struck by a laser beam. Make sure that laser beams do not strike the lens when shooting in an environment where laser devices are used.

■ Cards that you can use with this unit

SDHC Memory Card and SDXC Memory Card

- 4 GB or more Memory Cards that do not have the SDHC logo or 48 GB or more Memory Cards that do not have the SDXC logo are not based on SD Memory Card Specifications.
- Refer to page 30 for more details on SD cards.

■ For the purposes of these operating instructions

- The battery pack is referred to as the "Battery".
- SDHC Memory Card and SDXC Memory Card are referred to as the "SD card".
- Function that can be used for Recording Mode:  Function that can be used for Playback Mode: 
- Scene(s) recorded with [REC MODE] set to [MOV] or [MP4]: "MOV/MP4 scene(s)".
- Scene(s) recorded with [REC MODE] set to [AVCHD]: "AVCHD scene(s)".
- Pages for reference are indicated by an arrow, for example: → 00

Contents

Information for Your Safety	3
Accessories	12
Optional accessories	13

Preparation

What you can do with this unit	14
Recording to the SD card	14
Linking to external devices	14
Remote operations with an iPad	16
Names and Functions of Main Parts	17
Power supply	24
Charging the battery	24
Inserting/removing the battery	26
Charging and recording time	27
Connecting to the AC outlet	29
Preparation of SD cards	30
Cards that you can use with this unit	30
Inserting/removing an SD card	31
Turning the unit on/off	32
Selecting a mode	32
Using the LCD monitor/Viewfinder	33
Setting how to turn on/off the LCD monitor and Viewfinder	33
Using the LCD monitor	34
How to use the touch screen	35
LCD monitor adjustment	36
Viewfinder adjustment	37
Recording yourself	38
Setting date and time	39
Using the menu screen	41

Recording

Before recording	42
Selecting a media to record	42
Formatting media	43
Recording motion picture	43
Switching between Auto and Manual Mode	45
Adjusting the Picture Quality	47
Using the zoom	49
Image Stabilizer Function	51
Focus	53
One Push AF	56
Push AF	57
Focus Assist	57
Manual Focus Assist	60
Focus Transition	61
White Balance	64
Iris/Gain adjustment	68
Iris adjustment	68
Gain adjustment	70
Manual shutter speed	72
Audio Input	75
Switching Audio Input	75
Adjusting the audio input level	77
Counter display	79
Setting the Time Code	79
Setting the User Information	81
Setting the Recording Counter	82
Synchronizing the time code with an external device	83
USER button	84
Setting the USER button	84
Using the USER button	85
Functions of the USER button	86
Useful functions	108
Color Bar Screen	108
ND filter	109
Switching the screen indications/ mode information display	110
Using Operation Icons	111
Using of jog dial	112

Playback

Motion picture/Still picture playback	115
Motion picture playback using operation icon	119
Useful functions	120
Creating still picture from motion picture	120
Repeat Playback	121
Resuming the previous playback	121
Playing back scenes or still pictures by date	121

Editing

Deleting scenes/still pictures	123
Protecting scenes/still pictures	124
Copying between SD cards	125

Linking to external devices

Connecting Headphones, a Remote Control or an External Monitor	127
Headphones	127
Remote control	127
External monitor	128
Setting the external output resolution	130
Connecting to a PC (File transfer/nonlinear editing)	134
Operating environment (mass storage)	134
Connecting to a PC	135
About the PC display	136
Copying/playing back with an external media device	138
Preparing for copying/playing back	138
Copy once	141
Copy selected files	141
Playing back the External Media	142
Using an iPad as a Remote Control (AG ROP application)	143
Before connection	144
Connecting this unit and an iPad	147
Operations during AG ROP application connection	151

Menu

Using the Menu	152
Scene file	152
System mode	161
User switch	168
Switch setting	169
Auto switch setting	176
Recording Setup	178
Audio Setup	187
Output Setup	189
Display setting	192
Other Functions	197
Network Setup	200
Maintenance	201
Video Setup	202
Picture Setup	203
Copy	203

Display

Indications	204
Messages	207
Warning Indications	213

Others

Troubleshooting	216
About recovery	220
Updating the firmware incorporated into the unit	220
About copyright	221
Recording functions that cannot be used simultaneously	223
Recording modes/approximate recordable time	224
Approximate number of recordable pictures	226
Specification	227

Accessories

Check the accessories before using this unit.

Keep the accessories out of reach of children to prevent swallowing.

Battery pack*1



Battery charger



AC adaptor



AC cable

- In Saudi Arabia, always use

(A).



Lens hood*3



- *1 The part number of the battery pack is AG-VBR59. Before purchasing an extra battery pack, check the optional accessories section. To purchase extra accessories, contact your dealer.
- *2 The INPUT terminal caps are supplied with the microphone holder.
- *3 The lens hood is attached to this unit at the time of purchase.

Caution for AC Mains Lead

FOR YOUR SAFETY PLEASE READ THE FOLLOWING TEXT CAREFULLY.

This product is equipped with 2 types of AC mains cable, Type C (B) and Type BF (A). Appropriate mains cable must be used in each local area, since the other type of mains cable is not suitable.

Microphone holder (→ 23)



Microphone holder mounting screws (→ 23)

12 mm length
(2 screws)



Eye cup (→ 22)



INPUT terminal cap (2 caps)*2



Optional accessories

Some optional accessories may not be available in some countries.

Product numbers correct as of November 2016. These may be subject to change.

Unidirectional microphone (AG-MC200G)
Battery pack (VW-VBD58/AG-VBR59/AG-VBR89/AG-VBR118)
Battery charger (AG-B23/AG-BRD50)
LED video light (VW-LED1)

What you can do with this unit

Recording to the SD card

It is possible to record motion pictures and still pictures to the SD card using a variety of recording functions.

- This unit supports relay/simultaneous/background/dual codec recording using double card slots.

Linking to external devices

USB Device Mode

Transfer data (files) to perform nonlinear editing on another device (PC, etc.).

- This unit supports USB 3.0.

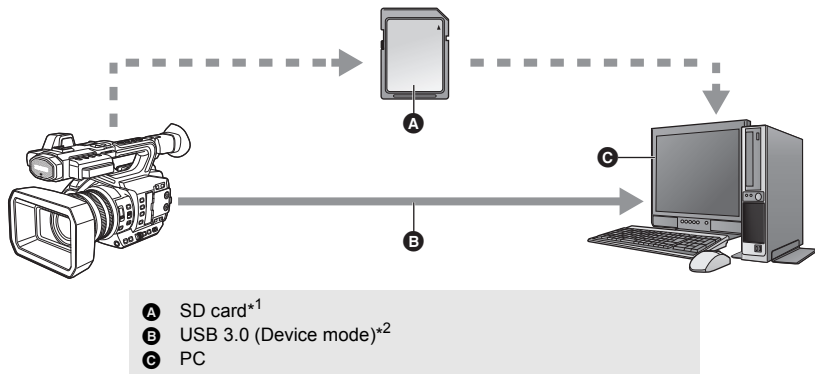

*1 SD cards are optional and not supplied with this unit.

*2 A USB 3.0 cable is not supplied with this unit. Use a commercially-available double-shielded USB 3.0 cable with a ferrite core.

If possible, we recommend using a cable with a length of 1.5 m or less.

USB Host Mode

If you connect an external media device, such as USB HDD or USB flash memory (commercially-available) to this unit, you can copy motion pictures and still pictures recorded on this unit to the external media device.

It can also play back the scenes and still pictures copied to the external media device.

- This unit supports USB 3.0.

Refer to the following support site for information about an external media device.

<http://pro-av.panasonic.net/>

(This Site is English only)

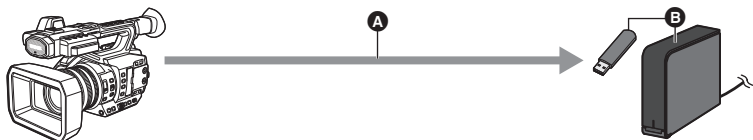

- A** USB 3.0 (Host mode)
- B** External media device (commercially-available)

Connecting to an external monitor

Connect an external monitor to output images.

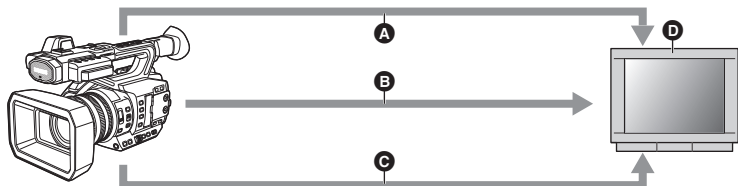

- A** AV cable*¹
- B** HDMI cable*²
- C** BNC cable*³
- D** External monitor

*¹ Use a commercially-available AV cable (with a four-conductor mini plug).

*² Use a commercially-available High Speed HDMI cable.

If possible, we recommend using a cable with a length of 3 m or less.

*³ To connect to the SDI OUT terminal, use a double-shielded BNC cable equivalent to 5C-FB (commercially-available).

When connecting with an HDMI cable using an HDMI-to-DVI converter, etc., be sure to connect the HDMI cable to the connector of this unit last.

Connecting the HDMI cable to the connector of this unit first may result in malfunction.

Remote operations with an iPad

Attaching a wireless module that support this unit (→ 144) to the USB HOST terminal of this unit allows you to connect to a wireless LAN network. You can perform the following operations by connecting this unit and an iPad on which the AG ROP application is installed:

- Checking the camera status
- Checking the thumbnail images of recorded scenes
- Playing back scenes recorded as sub recordings with [DUAL CODEC REC] set to [FHD 8Mbps]
- Controlling the camera remotely (recording control and Time Code/User Information operations)

Names and Functions of Main Parts

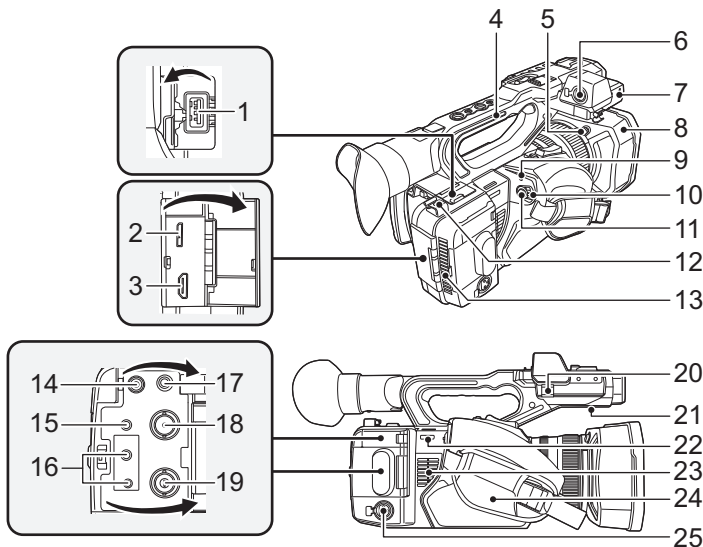

- 1 USB HOST terminal (→ 138, 143)
- 2 USB DEVICE terminal (→ 135)
- 3 HDMI OUT connector [HDMI] (→ 128)
- 4 Handle
- 5 Lens hood release button (→ 21)
- 6 Audio input terminal 1 (XLR 3 pin) [AUDIO INPUT1] (→ 23, 75)
- 7 Microphone holder attachment part (→ 23)
- 8 Lens hood (→ 21)
- 9 Status indicator (→ 32)
- 10 Power switch (→ 32)
- 11 Recording start/stop button (→ 43)
- 12 Cable holder
 - Secures an HDMI cable.
- 13 Inlet (cooling fan) (→ 42)
- 14 DC input terminal [DC IN] (→ 29)
 - Do not use any other AC adaptors except the supplied one.
- 15 AV OUT terminal (→ 128)
- 16 Camera remote terminal [CAM REMOTE] (→ 127)
 - FOCUS IRIS terminal (3.5 mm diameter mini jack)
 - ZOOM S/S terminal (2.5 mm diameter super mini jack)
- 17 Headphone terminal [] (→ 114, 127)
- 18 SDI OUT terminal (→ 128)
- 19 TC PRESET IN/OUT terminal (→ 83)
- 20 Microphone cable clamper (→ 23)
- 21 Speaker
- 22 Shoulder strap fixture
- 23 Inlet (cooling fan) (→ 42)
- 24 Hand strap (→ 22)
- 25 Audio input terminal 2 (XLR 3 pin) [AUDIO INPUT2] (→ 23, 75)

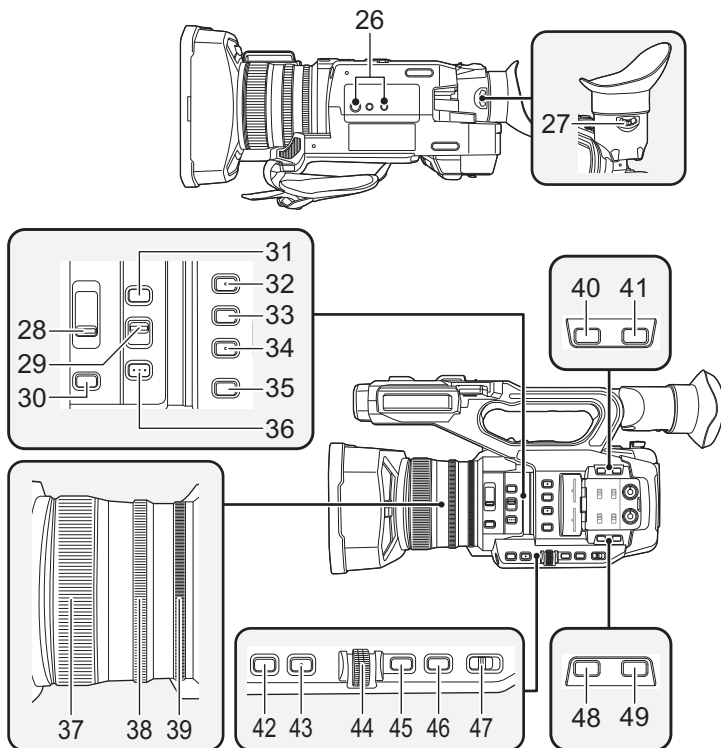

26 Tripod receptacle

- There are tripod mounting holes that are compatible with 1/4-20UNC and 3/8-16UNC screws. Use the size that matches the diameter of the tripod's fixing screw.
- Attaching a tripod with a screw length of 5.5 mm or more may damage the unit.

27 Eyepiece corrector lever (→ 37)

28 ND filter switch [ND FILTER] (→ 109)

29 Focus Auto/Manual/∞ switch [FOCUS A/M/∞] (→ 53)

30 Iris button [IRIS] (→ 68)

31 FOCUS ASSIST button (→ 57)

32 User 1 button [USER1] (→ 85)

33 User 2 button [USER2] (→ 85)

34 User 3 button [USER3] (→ 85)

35 Display/Mode check button [DISP/ MODE CHK] (→ 85, 110)

36 PUSH AUTO button (→ 53)

37 Focus ring (→ 53)

38 Zoom ring (→ 49)

39 Iris ring (→ 68)

40 User 6 button [O.I.S.] (→ 51, 85)

41 User 7 button [LCD/EVF] (→ 33, 85)

42 Gain button [GAIN] (→ 70)

43 White Balance button [WHITE BAL] (→ 64)

44 Jog dial [SEL/PUSH SET] (→ 64, 70, 72, 112, 117)

45 Menu button [MENU] (→ 41)

46 Shutter speed button [SHUTTER] (→ 72)

47 Auto/Manual switch [AUTO/MANU] (→ 45)

48 User 4 button [WFM] (→ 85, 97)

49 User 5 button [ZEBRA] (→ 85, 99)

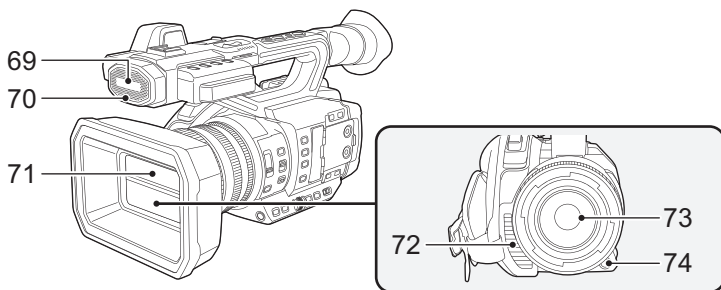
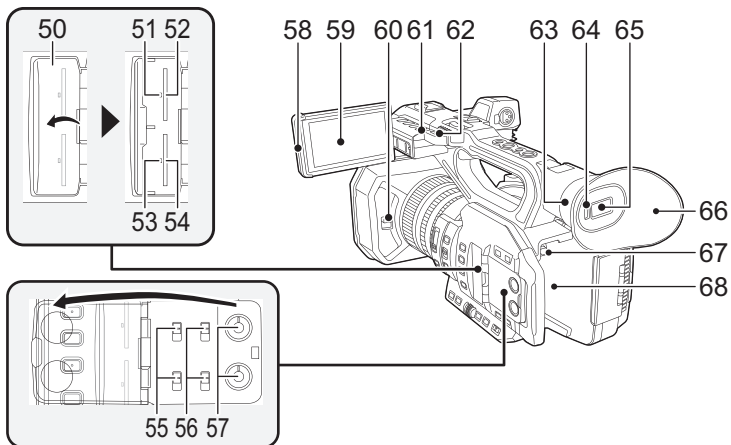

- 50 SD Card slot cover (→ 31)
- 51 Access lamp (card 1) (→ 31)
- 52 Card slot 1 (→ 31)
- 53 Access lamp (card 2) (→ 31)
- 54 Card slot 2 (→ 31)
- 55 INPUT1 / INPUT2 switches (→ 75)
- 56 CH1 SELECT/CH2 SELECT switches (→ 75)
- 57 AUDIO LEVEL CH1/AUDIO LEVEL CH2 knobs (→ 77)
- 58 LCD monitor extract part (→ 34)
- 59 LCD monitor (Touch screen) (→ 35)
- 60 Lens cover open/close lever (→ 21)
- 61 Recording lamp (Rear) (→ 197)
- 62 Shoulder strap fixture
- 63 Eye cup mount (→ 22)
- 64 Eye sensor (→ 38)
- 65 Viewfinder (→ 37)
- 66 Eye cup (→ 22)
- 67 Battery release button [PUSH] (→ 26)
- 68 Battery holder (→ 26)
- 69 Built-in microphone
- 70 Recording lamp (Front) (→ 197)
- 71 Lens cover (→ 21)
- 72 Exhaust opening (cooling fan) (→ 42)
- 73 Lens (LEICA DICOMAR)
- 74 User 9 button [AWB] (→ 64, 85)

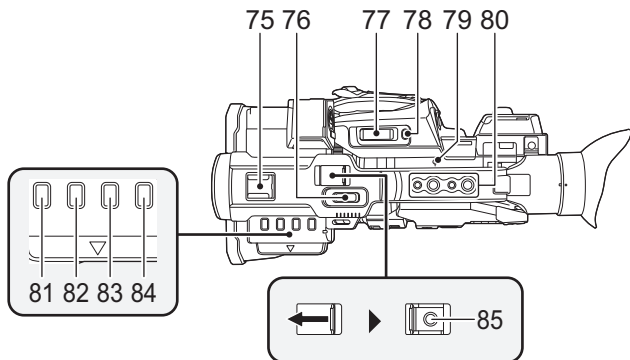

75 Accessory shoe

76 Sub zoom lever (→ 49, 175)

- This lever functions in the same manner as the zoom lever.
- The zoom speed is controlled with this lever in a way different from the way it is controlled with the zoom lever. (→ 50)

77 Zoom lever [T/W] (→ 49) (In Recording Mode)

Volume lever [+VOL-] (→ 117)/
Thumbnail display switch [Q/]
(→ 117) (In Playback Mode)

78 User 8 button [REC CHECK] (→ 85, 90)

79 Focal plane index [ϕ]

- Indicates the focal plane of the MOS sensor.

80 Handle mounting hole

(Size of the mounting hole)

- 1/4-20UNC×2
- 3/8-16UNC×2

81 Thumbnail button [THUMBNAIL] (→ 32)

82 Counter button [COUNTER] (→ 79)

83 Counter reset/Time code setting button [RESET/TC SET] (→ 81, 83)

84 Color Bar Screen button [BARS] (→ 108)

85 Sub recording start/stop button (→ 175)

- This button functions in the same manner as the recording start/stop button.

■ Attaching/detaching the lens hood

(How to detach the lens hood)

While pressing and holding the lens hood release button, rotate the lens hood in the direction of the arrow to detach it.

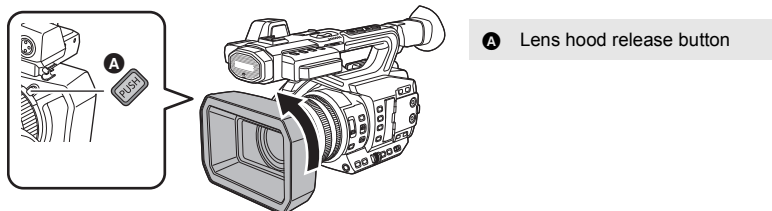

(How to attach the lens hood)

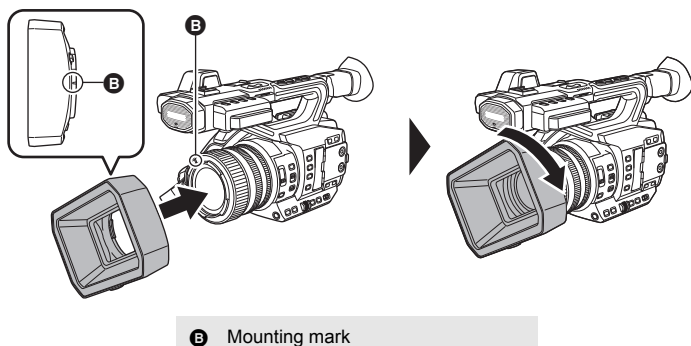

1 Fit the lens hood into this unit.

- Align the mounting mark on the lens hood with the mounting mark on this unit.

2 Rotate the lens hood in the direction of the arrow.

- Rotate until it clicks into place.

Opening/closing the lens cover

You can open/close the lens cover by sliding the lens cover open/close lever.

- When this unit is not in use, close the lens cover to protect the lens.

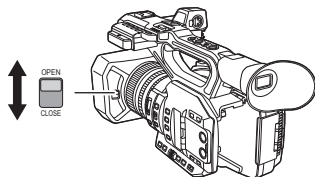

- Do not press the lens cover hard. This may damage the lens or the lens cover.
- Depending on the various filters or the MC protector attached to the front side of this unit's lens, you may not be able to open/close the lens cover or attach the lens hood.

■ Adjust the length of the hand strap so that it fits your hand.

Adjust the hand strap according to the size of your hand.

- If you find it difficult to fasten the buckle **(B)**, move the pad **(A)** forward, and fasten the buckle **(B)** again.

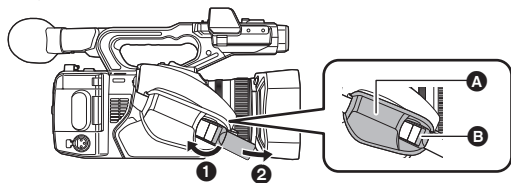

- 1 Open the buckle.
- 2 Pull the end of the belt.

■ Attaching the eye cup

- 1 Align the mounting mark on the eye cup mount with the corresponding mark on the eyecup.
- 2 Attach the eye cup so that the notch on the eye cup mount is aligned with the protrusion inside the eye cup.

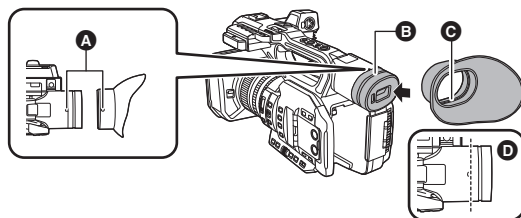

- A** Mounting marks
- B** Notch
- C** Protrusion

- Push the eye cup in until it reaches the mounting mark. **(D)**

■ Attaching the front microphone

- The microphone holder is set up so that a 21 mm external microphone (AG-MC200G: optional) can be attached. Check in advance whether the microphone you wish to use can be attached.

1 Attach the microphone holder to the microphone holder attachment part.

- Attach by using a commercially available screw driver.
- When attaching the microphone holder, be sure to tighten the screws firmly even though you might hear a squeaking sound.

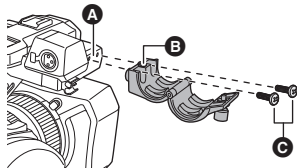

- A** Microphone holder attachment part
- B** Microphone holder
- C** Microphone holder mounting screws

2 Attach an external microphone (optional) to the microphone holder, and tighten the microphone holder screw.

3 Connect the external microphone to the AUDIO INPUT1 terminal (XLR 3 pin).

- When wiring the microphone cable, use the cable clamber of this unit.
- Keep the microphone holder screw, INPUT terminal cap out of reach of children to prevent swallowing.

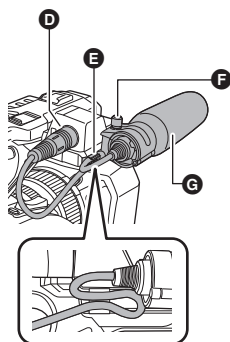

- D** AUDIO INPUT1 terminal (XLR 3 pin)
- E** Microphone cable clamber
- F** Microphone holder screw
- G** External microphone (optional)

■ Attaching the INPUT terminal cap

Attach the INPUT terminal cap while the AUDIO INPUT1, 2 terminals (XLR 3 pin) are not used.

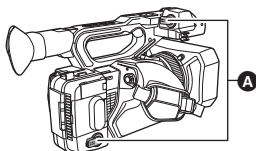

- A** INPUT terminal cap

Power supply

■ About batteries that you can use with this unit (as of November 2016)

The battery that can be used with this unit is VW-VBD58/AG-VBR59/AG-VBR89/AG-VBR118.

- The AG-VBR59/AG-VBR89/AG-VBR118 supports quick charging.

It has been found that counterfeit battery packs which look very similar to the genuine product are made available to purchase in some markets. Some of these battery packs are not adequately protected with internal protection to meet the requirements of appropriate safety standards. There is a possibility that these battery packs may lead to fire or explosion. Please be advised that we are not liable for any accident or failure occurring as a result of use of a counterfeit battery pack. To ensure that safe products are used we would recommend that a genuine Panasonic battery pack is used.

Charging the battery

When this unit is purchased, the battery is not charged. Charge the battery fully before using this unit for the first time.

Important:

- Do not use the AC cable with any other equipment as it is designed only for this unit. Also, do not use the AC cable from other equipment with this unit.
- It is recommended to charge the battery in a temperature between 10 °C and 30 °C. (The battery temperature should also be the same.)

■ About the Battery Charger

This unit can charge two battery packs simultaneously and supports quickcharging batteries.

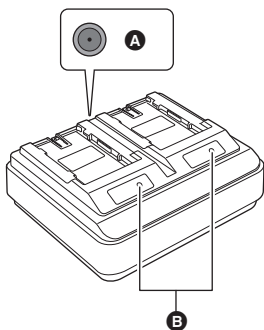

- A DC IN 12 V connector
- B CHARGE indicators [CHARGE 1/CHARGE 2]

CHARGE indicators [CHARGE 1/CHARGE 2]

Indicate the charge status as follows.

Indicator	Charge status
Lit green	Quick charging is in progress. (Battery charging time: → 27)
Lit orange	Normal charging is in progress.
Blinking orange	Charging has stopped due to an error. (→ 7)
Off	Charging is complete, or a battery pack is not inserted.

DC IN 12 V connector [⬠⬠⬠⬠]

Connects to the DC plug of the AC adaptor.

■ Charging the battery

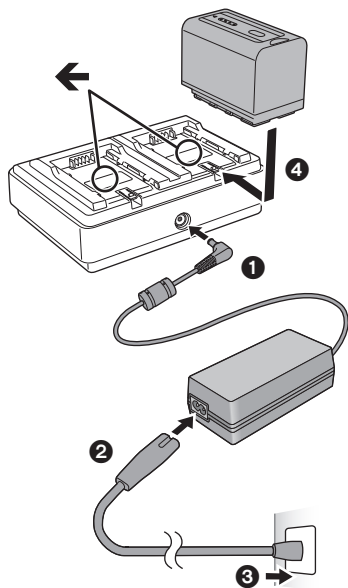

1 Connect the DC plug of the AC adaptor to the DC IN 12 V connector of battery charger.

2 Connect the AC mains lead to the AC adaptor.

- Perform step **2** first, and then step **3**. Insert the AC mains lead all the way in until it stops.

3 Insert the battery into the battery charger.

- Slide the battery horizontally into the battery charger along the “←” mark.
- The corresponding CHARGE indicator lights and charging starts.
- The CHARGE indicator turns off when charging is complete. Slide the battery to remove it.

-
- We recommend using Panasonic batteries (→ 27).
 - If you use other batteries, we cannot guarantee the quality of this product.
 - Do not heat or expose to flame.
 - Do not leave the battery(ies) in a car exposed to direct sunlight for a long period of time with doors and windows closed.
 - After the battery is inserted, it may take some time for it to be detected and the CHARGE indicator to light. If the CHARGE indicator does not light after 10 seconds, insert the battery again.
 - If two batteries that support quick charging are inserted, priority will be given to the battery inserted in the CHARGE 1 slot, and the battery inserted in the CHARGE 2 slot will be charged in normal-charge mode. When charging on the CHARGE 1 slot progresses to a certain point, charging on the CHARGE 2 slot will automatically switch to quick-charge mode. In addition, the charge indicator (LED lamps) on the battery inserted in the CHARGE 2 slot may turn off depending on the charge status of the battery.
 - The battery charger determines the state of the battery first to perform optimal charging. It will, as a result, take about 20 seconds for charging to start after the CHARGE indicator on the battery charger lights. When charging starts, the charge indicator (LED lamps) on a battery that supports quick charging will flash. If you remove and reinsert a battery or swap batteries while charging is in progress on both the CHARGE 1 and CHARGE 2 slots, charging for both batteries will stop temporarily, and the battery charger will determine the state of the batteries again before restarting. Therefore, it will take about 20 seconds to restart charging.
 - Insert the battery that you want charged first in the CHARGE 1 slot.

Inserting/removing the battery

Install the battery by inserting it in the direction shown in the figure.

- Insert the battery until it clicks and locks.

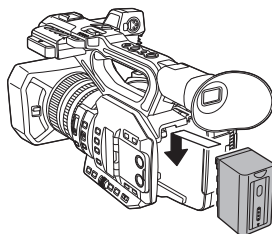

Removing the battery

Make sure that the power switch is set to OFF and the status indicator is turned off, and then remove by holding onto it taking care not to drop. (→ 32)

While pressing the battery release button, remove the battery.

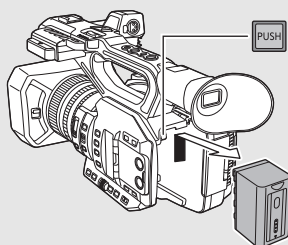

Charging and recording time

Charging/Recording time

Battery model number	Voltage/Capacity (minimum)	Charging time	System Frequency setting (→ 161)	Continuously recordable time
Supplied battery/ AG-VBR59 (optional)	7.28 V/5900 mAh	3 h 20 min	59.94 Hz	3 h 25 min
			50.00 Hz	3 h 35 min
AG-VBR89 (optional)	7.28 V/8850 mAh	4 h	59.94 Hz	5 h 10 min
			50.00 Hz	5 h 30 min
AG-VBR118 (optional)	7.28 V/11800 mAh	4 h 40 min	59.94 Hz	6 h 50 min
			50.00 Hz	7 h 15 min
VW-VBD58 (optional)	7.2 V/5800 mAh	5 h 20 min	59.94 Hz	3 h 20 min
			50.00 Hz	3 h 35 min

- The above charging times apply when the supplied battery charger is used.
- The times given apply when the ambient operating temperature is 25 °C and the relative operating humidity is 60%. Charging time may be longer at other temperatures and humidity levels.
- The continuous recordable time given applies under the conditions below. The time becomes shorter under other conditions.
 - The LCD monitor is open
 - A cable is not inserted to the external output terminal
- "h" is an abbreviation for hour, "min" for minute and "s" for second.
- These times are approximations.
- **The indicated charging time is for when the battery has been discharged completely. Charging time and recordable time vary depending on the usage conditions such as high/low temperature.**



-
- The batteries heat up after use or charging. This is not a malfunction.
 - The optional battery charger AG-B23 (DE-A88) can be used to charge the battery but charging will take longer.

Checking the remaining power of the battery

You can check the remaining power of the battery by looking at the battery capacity indication displayed on this unit's screen or by looking at the supplied battery AG-VBR59.

■ Checking the remaining power using this unit

Battery capacity indication

- The display changes as the battery capacity reduces.  If the battery discharges, then  will flash red.

- Depending on the menu setting, the battery capacity indication is not displayed (→ 195)
[DISP SETUP] → [CARD & BATTERY]

■ Checking the remaining power using the battery

If you press the CHECK button when charging is not in progress, the indicator (LED lamps) will light in green so that you can check the remaining power of the battery.

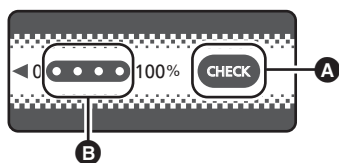











- A** CHECK button
- B** Indicator

- The remaining power of the battery is an approximate guide.
- When the LED lamp does not light up even if you press the CHECK button, the battery is exhausted. Charge the battery.

How to read the indicator

An approximate guide of the charging progress is indicated by the flashing position of the LED lamps when charging is in progress. The LED lamps turn off when charging is complete.

:Flashing in green/ :Lit in green/ :Off

LED lamp status		Remaining power of the battery / Charging progress
When checking the remaining power	During charging	
		0% to 25%
		25% to 50%
		50% to 75%
		75% to 100%

- The display of the indicator is an approximate guide. When the battery pack is connected to the video camera or the charger, refer to the remaining power display of the connected device. The display of the connected device may differ from that of the battery pack's indicator.

Connecting to the AC outlet

The unit is in the standby condition when the AC adaptor is connected. The primary circuit is always "live" as long as the AC adaptor is connected to an electrical outlet.

Important:

- Use the supplied AC adaptor. Do not use the AC adaptor of another device.
- Do not use the AC cable with any other equipment as it is designed only for this unit. Also, do not use the AC cable from other equipment with this unit.

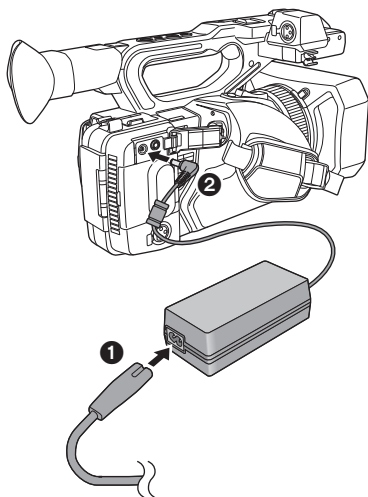

1 Connect the AC cable to the AC adaptor and the AC outlet.

2 Connect the AC adaptor to the DC input terminal [DC IN].

- Make sure to set the power switch to OFF and the status indicator is turned off when disconnecting the AC adaptor. (→ 32)

- Insert the plugs as far as they will go.

-
- Even when you use the AC adaptor for recording images, keep the battery connected. This allows you to continue the recording even if a power failure occurs or the AC adaptor is unplugged from the AC outlet by accident.
 - This unit consumes a small amount of power even when turned off. When leaving the product unused for a long time, disconnect the AC adaptor from the AC outlet for power saving.

Preparation of SD cards

The unit can record motion pictures or still pictures to an SD card.

Cards that you can use with this unit

- The cards that you can use are correct as of November 2016.
- We recommend that you use a Panasonic Memory Card.

Card type	Capacity
SDHC Memory Card	4 GB to 32 GB
SDXC Memory Card	48 GB to 128 GB

- We do not guarantee the operation of SD cards other than the ones above.
- 4 GB or more Memory Cards that do not have the SDHC logo or 48 GB or more Memory Cards that do not have the SDXC logo are not based on SD Memory Card Specifications.
- This unit is compatible with UHS-I UHS Speed Class3 standard SDHC/SDXC Memory Cards.
- When the write-protect switch **A** on SD card is locked, no recording, deletion or editing will be possible on the card.
- Keep the Memory Card out of reach of children to prevent swallowing.

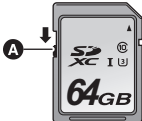

■ About the Speed Class ratings for recording motion pictures

- Depending on [REC MODE] (→ 161) and [REC FORMAT] (→ 162), the required card differs. Use a card that meets the following ratings of the SD Speed Class or UHS Speed Class. Use of a non-compatible card may cause recording to stop suddenly.
- SD Speed Class and UHS Speed Class are the speed standards regarding continuous writing. To check the class, see the labelled side, etc. of the card.

Recording modes	Recording function or Recording format	Speed Class ratings	Label examples
MOV/MP4	VFR Mode, Super Slow Recording, 100 Mbps or more	UHS Speed Class3*	U3
	50 Mbps	UHS Speed Class1 or more	U1
		Class10 or more	CLASS10
AVCHD	All	Class4 or more	CLASS4

* If you select [UHD 2160/59.94p 150M] or [UHD 2160/50.00p 150M], you will need an SDXC Memory Card with a capacity of at least 64 GB that supports UHS Speed Class3.

Inserting/removing an SD card

When using an SD card for the first time, it is necessary to format the SD card. (→ 43) When the SD card is formatted, all of the recorded data is deleted. Once the data is deleted, it cannot be restored.

Caution:

Check that the access lamp has gone off.

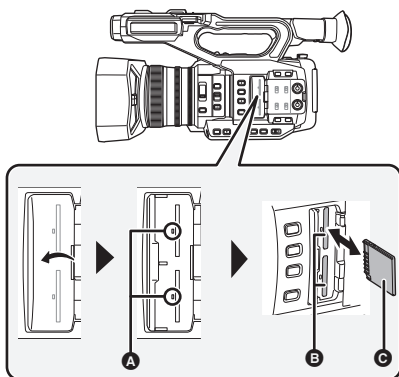

Access lamp **A**

- When this unit is accessing the SD card, the access lamp lights up.

1 Open the SD card slot cover and insert (remove) the SD card into (from) the card slot **B**.

- One SD card can be inserted into each of the card slot 1 and the card slot 2.
- Face the terminal side **C** in the direction shown in the illustration and press it straight in as far as it will go.
- Press the center of the SD card and then pull it straight out.

2 Securely close the SD card slot cover.

- Do not touch the terminals on the back of the SD card.
- Do not apply strong shocks, bend, or drop the SD card.
- Electrical noise, static electricity or the failure of this unit or the SD card may damage or erase the data stored on the SD card.
- When the card access lamp is lit, do not:
 - Remove the SD card
 - Turn the unit off
 - Insert and remove the USB Cable
 - Expose the unit to vibrations or shockPerforming the above while the lamp is on may result in damage to data/SD card or this unit.
- Do not expose the terminals of the SD card to water, dirt or dust.
- Do not place SD cards in the following areas:
 - In direct sunlight
 - In very dusty or humid areas
 - Near a heater
 - Locations susceptible to significant difference in temperature (condensation can occur.)
 - Where static electricity or electromagnetic waves occur
- To protect SD cards, return them to their cases when you are not using them.
- About disposing of or giving away the SD card. (→ 7)

Turning the unit on/off

Set the power switch to ON while pressing the lock release button **B** to turn on the unit.

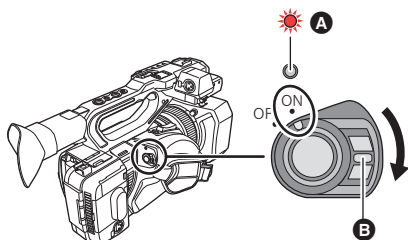

To turn off the unit

Set the power switch to OFF while pressing the lock release button. The status indicator goes off.

A The status indicator lights on.

- To turn on the unit again after the [ECONOMY (BATT)] or [ECONOMY (AC)] is activated, set the power switch to OFF once, and then to ON again. (→ 198)

Selecting a mode

Press the THUMBNAIL button to change the mode to Recording Mode or Playback Mode.

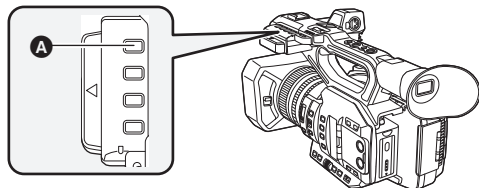

A THUMBNAIL button

Recording Mode (→ 43)	The recording screen is displayed. You can record motion pictures.
Playback Mode (→ 115)	The thumbnail screen for playback is displayed. You can play back motion pictures and still pictures.

- When you turn on this unit, it starts up in Recording Mode.
- If you press the recording start/stop button or sub recording start/stop button in Playback Mode, the mode will be switched to Recording Mode and recording will start.

Using the LCD monitor/Viewfinder

Setting how to turn on/off the LCD monitor and Viewfinder

Select the menu. (→ 41)

 : [OUTPUT SETUP] → [LCD/EVF OUTPUT] → desired setting

[AUTO]: The LCD monitor is turned on when the LCD monitor is extracted. When you move your eye closer to the eye cup of the viewfinder, the LCD monitor is turned off, and the viewfinder is turned on.

[LCD]: The LCD monitor is turned on when the LCD monitor is extracted. The viewfinder is not turned on.

■ To change the setting with a USER button

You can change how to turn on/off the LCD monitor and Viewfinder by registering [LCD/EVF OUTPUT] to a USER button.

- This function is registered to the USER7 button by default.
- Please refer to page 84 for details about setting the USER button.

When the recording screen is displayed, press the USER button to which [LCD/EVF OUTPUT] is registered.

- Switches the setting each time the button is pressed.
[AUTO] ↔ [LCD]
 - The setting is also applied to the [LCD/EVF OUTPUT] menu setting.
-
- If you wear certain types of glasses or hold the camera in certain ways, or when the eyepiece area is exposed to bright light, the eye sensor may not work correctly.
 - If the eye sensor does not work correctly, adjust the [EYE SENSOR] setting. (→ 38)
 - You can turn on/off the viewfinder by registering [EVF ON/OFF] to a USER button.

Using the LCD monitor

1 Extract the LCD monitor in the direction as indicated in the figure.

- Hold the LCD monitor extract part **A**, and extract the LCD monitor until it clicks into position.

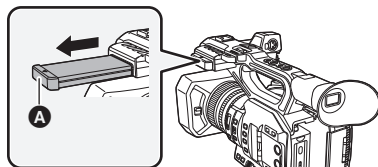

2 Rotate to the position that is easy to view.

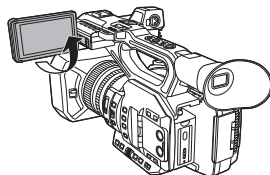

To retract the LCD monitor

Retract as shown in the figure with the LCD facing downward.

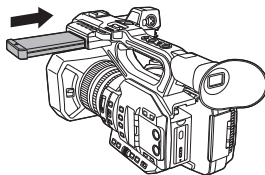

Range of rotation of the LCD monitor

- It can rotate up to 270° towards the lens.

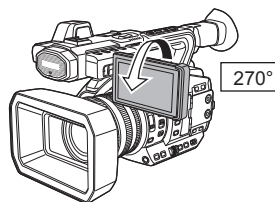

How to use the touch screen

You can operate by directly touching the LCD monitor (touch screen) with your finger.

■ Touch

Touch and release the touch screen to select icon or picture.

- Touch the center of the icon.
- Touching the touch screen will not operate while you are touching another part of the touch screen.

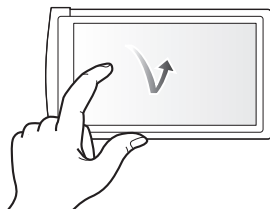

■ Slide while touching

Move your finger while pressing on the touch screen.

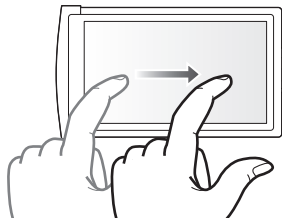

■ About the operation icons



Touch when changing a page or performing settings.

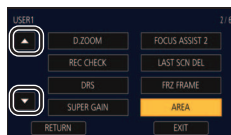

- Do not touch the LCD monitor with hard pointed tips, such as ball point pens.

LCD monitor adjustment

- These settings will not affect the images actually recorded.

[POWER LCD]

This makes it easier to view the LCD monitor in bright places including outdoors.

Select the menu. (→ 41)

 : [DISP SETUP] → [POWER LCD] →
[+1] (Makes brighter)/[0] (Normal)/[-1] (Makes less bright)

- When the AC adaptor is in use, [POWER LCD] is set to [+1] automatically.
- [0] is selected when:
 - [USB MODE SELECT] is set to [DEVICE] and this unit is connected to a PC. (→ 135)
- This item is not available while the LCD monitor is turned off.

[LCD SET]

It adjusts brightness and color density on the LCD monitor.

1 Select the menu. (→ 41)

 : [DISP SETUP] → [LCD SET]

2 Touch the desired setting item.

[COLOR]:	Color level of the LCD monitor
[BRIGHTNESS]:	Brightness of the LCD monitor
[CONTRAST]:	Contrast of the LCD monitor

3 Touch  /  to adjust settings.

- You can select a value between -16 and +16.

4 Touch [RETURN].

- Touch [EXIT] to exit the menu screen.

- This item is not available while the LCD monitor is turned off.

Viewfinder adjustment

- These settings will not affect the images actually recorded.

Adjusting the field of view

It adjusts the field of view to show the image on the viewfinder clearly.

1 Adjust the viewfinder to suit your vision so that you can see the display images clearly.

- Be careful not to trap your fingers when moving the viewfinder.

- The viewfinder can be lifted vertically up to approximately 90°.

- Bring your eye close to the viewfinder to turn it on.

2 Adjust the focus by operating the eyepiece corrector lever.

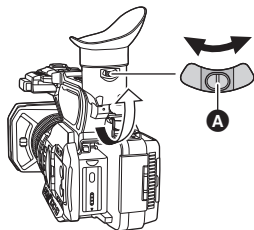

A Eyepiece corrector lever

[EVF SETTING]

It adjusts brightness and color density of the viewfinder.

- Use the jog dial to change the settings. (→ 112)

1 Select the menu. (→ 41)

MENU : [DISP SETUP] → [EVF SETTING] → desired setting

[COLOR]: Color level of the viewfinder

[BRIGHTNESS]: Brightness of the viewfinder

[CONTRAST]: Contrast of the viewfinder

2 Rotate the jog dial to move the cursor to the value display **A**.

- Push the jog dial to select the value display.

3 Rotate the jog dial to adjust the setting.

- Pushing the jog dial will set the value you have selected.

- You can select a value between -16 and +16.

4 Select [RETURN].

- Select [EXIT].

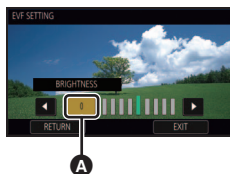

- This item is not available while the viewfinder is turned off.
- When [COLOR] is set to -16, images are displayed in black and white.

[EVF COLOR]

The recording images or playback images on the viewfinder can be selected between color/black and white.

Select the menu. (→ 41)

 : [DISP SETUP] → [EVF COLOR] → [ON] or [OFF]

[ON]: Displayed in color

[OFF]: Displayed in black and white

- If you adjust the [COLOR] setting in [EVF SETTING], [EVF COLOR] will be set to [ON].

[EYE SENSOR]

It adjusts sensitivity of eye sensor.

1 Select the menu. (→ 41)

 : [DISP SETUP] → [EYE SENSOR]

2 Touch  /  to adjust settings.

- You can select a value between -4 and +4.

3 Touch [EXIT] to complete the setting.

- When the [LCD/EVF OUTPUT] is set to [LCD], this item cannot be set. (→ 33)

Recording yourself

- Change the mode to Recording Mode. (→ 32)

Rotate the LCD monitor towards the lens side.

- Displaying during the recording yourself can be switched by setting [SELF SHOOT]. (→ 196)

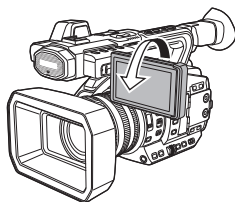

- Only some indications will appear on the screen when the [SELF SHOOT] is set to [MIRROR]. When  appears, return the direction of the LCD monitor to normal position and check the warning/alarm indication. (→ 207)
- When the viewfinder is turned up, the LCD monitor is turned off.

Setting date and time

When this unit is turned on, the message [SET TIME ZONE AND DATE/TIME] may appear. To make these settings, select [YES], and follow the instructions from Step 2-3 of the time zone setting procedure.

Time zone

Time difference from the Greenwich Mean Time can be set.

1 Select the menu. (→ 41)

MENU  : [OTHER FUNCTION] → [TIME ZONE]

2 Touch / and set the region to record.

3 Touch [EXIT] to complete the setting.

- If the [CLOCK SET] screen appears, perform [CLOCK SET].
- When the time zone setting is changed, the date/time setting of the unit also changes automatically.

Clock setting

1 Select the menu. (→ 41)

MENU  : [OTHER FUNCTION] → [CLOCK SET]

2 Touch the date or time to be set, then set the desired value using / .

- The year can be set between 2000 and 2039.

3 Touch [EXIT] to complete the setting.

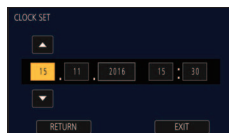

- The date and time function is driven by a built-in lithium battery.
- If the time display becomes [- -], the built-in lithium battery needs to be charged. To recharge the built-in lithium battery, connect the AC adaptor or attach a charged battery to this unit. Leave the unit as it is for approx. 24 hours and the battery will maintain the date and time for approx. 6 months. (The battery is still being recharged even if the unit is off.)
- The way that time is displayed can be changed in the menu settings. (→ 194) [DISP SETUP] → [DATE/TIME] or [DATE FORMAT]

■ Time zone table

Time difference	Region	Time difference	Region
0:00	London, Casablanca	+3:30	Tehran
-1:00	Azores	+4:00	Dubai, Abu Dhabi
-2:00	Fernando de Noronha	+4:30	Kabul
-3:00	Rio de Janeiro, Sao Paulo, Buenos Aires	+5:00	Islamabad, Karachi, Male
-3:30	Newfoundland	+5:30	Delhi, Kolkata, Mumbai, Chennai, Colombo
-4:00	Manaus, La Paz	+5:45	Kathmandu
-4:30	Caracas	+6:00	Dhaka
-5:00	Toronto, New York, Miami, Lima	+6:30	Yangon
-6:00	Chicago, Houston, Mexico City	+7:00	Bangkok, Jakarta
-7:00	Denver, Phoenix	+8:00	Beijing, Hong Kong, Kuala Lumpur, Singapore
-8:00	Vancouver, Seattle, Los Angeles	+9:00	Seoul, Tokyo
-9:00	Alaska, Anchorage	+9:30	Adelaide
-10:00	Hawaii, Honolulu, Tahiti	+10:00	Guam, Sydney
-11:00	Midway Islands	+11:00	Solomon Islands, New Caledonia
+1:00	Berlin, Paris, Rome, Madrid	+12:00	Fiji, Auckland, Wellington
+2:00	Helsinki, Athens, Cairo, Johannesburg	+12:45	Chatham Islands
+3:00	Moscow, Kuwait, Riyadh, Nairobi		

Using the menu screen

- You can also select menu items by operating the jog dial. (→ 112)

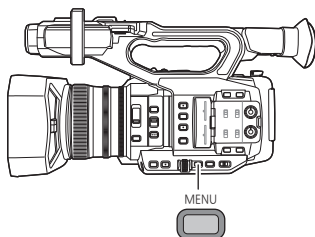

1 Press the MENU button .

2 Touch the top menu **A**.

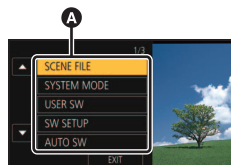

3 Touch the submenu **B**.

- Next (Previous) page can be displayed by touching

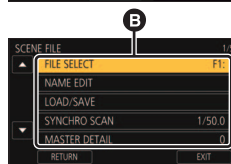

4 Touch the desired item to enter the setting.

5 Touch [EXIT] to exit the menu setting.

Before recording

- When recording, make sure your footing is stable and there is no danger of colliding with another person or object.
- Hold the eye cup of the viewfinder as close as possible to your eye.
- Adjust the angle of the LCD monitor according to the position in which the unit is held.
- When you are outdoors, record pictures with the sunlight behind you. If the subject is backlit, it will become dark in the recording.
- Keep your arms near your body and separate your legs for better balance.
- For stable images, it is recommended to use a tripod whenever possible.
- Do not block the cooling fan inlet or the exhaust opening with your hand or other objects.



Selecting a media to record

You can specify the card slot to which motion pictures are to be recorded.

Select the menu.

 : [RECORD SETUP] → [MEDIA SELECT] → [SD CARD 1]/[SD CARD 2]

- In the following situation, if you start recording with normal settings or start recording when [2 SLOTS FUNC.] (→ 178) is set to [RELAY REC], the card slot used for motion picture recording will be switched automatically:
 - An SD card is not inserted to the card slot selected in [MEDIA SELECT], or the SD card in the selected card slot is full when there is another SD card in the other slot.
- You can also change the card slot used for motion picture recording by pressing the USER button to which [SLOT SEL] is registered or touching the applicable USER button icon while recording is paused. (→ 84)

Formatting media

If you use the SD cards for the first time for recording with this unit, format the cards. Please be aware that if a medium is formatted, then all the data recorded on the medium will be erased and cannot be restored. Back up important data on a PC etc. (→ 134)

- When using two SD cards, format both SD cards.

1 Select the menu.

MENU : [OTHER FUNCTION] → [FORMAT MEDIA]

2 Touch [SD CARD 1] or [SD CARD 2].

- When formatting is complete, touch [EXIT] to exit the message screen.
- Do not turn this unit off or remove the SD card, while formatting. Do not expose the unit to vibrations or shock.

Use this unit to format media.

Do not format an SD card using any other equipment such as a PC. Otherwise it may not be possible to use the card on this unit.

Recording



Recording motion picture

- Before turning on this unit, open the lens cover. (→ 21)

1 Change the mode to Recording Mode. (→ 32)

- Extract the LCD monitor.

2 Press the recording start/stop button **B** to start recording.

- Recording will stop when you press the recording start/stop button again.

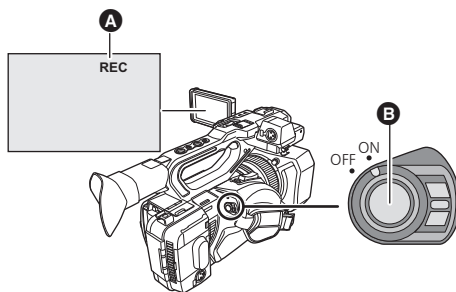

- A** When you begin recording, REC (red) is displayed.

■ Screen indications in the Recording Mode



TC 00:00:00:00	Counter display (→ 79)
1 / 2 (White)	Card slot number
R 1h20m	Approximate remaining recordable time • When the remaining time is less than 1 minute, R 0h00m flashes red.
[MAIN]	Card slot selected for motion picture recording (→ 42)*
[UHD 2160]	Recording format (→ 162)
150M	Bit rate (→ 162)
[MP4]	Recording mode (→ 161)
50.00p	Frame rate (→ 162)

* Displayed only during normal recording.

- To change the recording method, change [REC MODE] or [REC FORMAT]. (→ 161, 162)
- The images recorded between pressing the recording start/stop button to start recording and pressing it again to pause recording become one scene.
- When the file size of a recorded scene exceeds one of the following sizes or the recording time exceeds one of the following lengths of time, the scene will be divided automatically. (Recording continues.)

AVCHD scene	Approximately 4 GB
MOV/MP4 scene (when using an SDHC Memory Card)	Approximately 4 GB or 30 minutes
MOV/MP4 scene (when using an SDXC Memory Card)	Approximately 96 GB or 3 hours

- (Maximum recordable scenes of a single SD card)

Recording mode	MOV/MP4	AVCHD
Recordable scenes	Approx. 89100	Approx. 3900
Different dates (→ 121)	Approx. 900	Approx. 900

- When the SD card contains scenes recorded with [REC MODE] set to [MOV]/[MP4] and still pictures, the maximum recordable scenes and the maximum recordable scenes on each date will be smaller than those in the table above.
- Number of scenes that can be recorded will be less than above in following cases:
 - If you change [REC FORMAT]
 - When [2 SLOTS FUNC.] is set to [SIMULTANEOUS] or [DUAL CODEC] (→ 178)
 - During the Interval Recording (→ 183)
- Please refer to page 224 about approximate recordable time.



Switching between Auto and Manual Mode

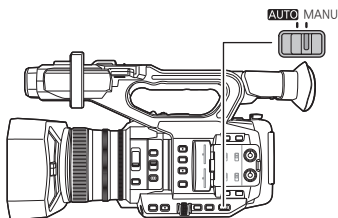

AUTO/MANU switch

Slide the switch to change Auto Mode/Manual Mode.

- **A** is displayed in the Auto Mode.

■ Auto Mode

In Auto Mode, this unit operates according to the [AUTO SW] menu settings.

- When the following settings are automatically adjusted in Auto Mode, the corresponding Manual Mode settings are canceled:
 - Focus (→ 53)
 - Iris (→ 68)
 - GAIN (→ 70)
 - Shutter speed (→ 72)

■ To enable/disable auto switch functions

You can enable/disable functions that are automatically adjusted in Auto Mode.

Select the menu.

 : [AUTO SW] → desired setting

Menu item	Setting
[A.IRIS]	<p>[ON]: Activates Auto Iris in Auto Mode.</p> <p>[OFF]: Activates Auto Iris as a manual mode. Use the IRIS button to switch between Auto Iris Mode and Manual Iris Mode.</p>
[AGC]	<p>[ON]: Activates Auto Gain in Auto Mode.</p> <p>[OFF]: Activates Auto Gain as a manual mode. The gain is adjusted according to the settings assigned to the GAIN button.</p>
[AUTO SHUTTER]	<p>[ON]: Activates Auto Shutter in Auto Mode.</p> <p>[OFF]: Activates Auto Shutter as a manual mode. Press the SHUTTER button to switch between Auto Shutter Mode and Manual Shutter Mode.</p>
[ATW]	<p>[ON]: Activates Auto Tracking White Balance in Auto Mode.</p> <p>[OFF]: Activates Auto Tracking White Balance as a manual mode. White Balance is adjusted according to the settings of the WHITE BAL button and the USER button to which [AWB] is registered. (→ 64)</p>

Menu item	Setting
[AF]	<p>[ON]: Activates Auto Focus in Auto Mode.</p> <p>[OFF]: Activates Auto Focus as a manual mode. Focus is adjusted according to the functions of the FOCUS A/M/∞ switch.</p>

Automatic Tracking White Balance

The Auto Tracking White (ATW) Balance function of this unit automatically adjusts the White Balance according to the lighting condition.

If Auto Tracking White Balance does not work correctly, switch to Manual Mode first, and then adjust the White Balance. (→ 64)

Auto Focus

The unit focuses automatically.

- Auto Focus does not work correctly in the following situations. Record pictures in the Manual Focus Mode. (→ 53)
 - Recording distant and close-up objects at the same time
 - Recording a subject behind dirty or dusty window
 - Recording a subject that is surrounded by objects with glossy surfaces or by highly reflective objects

■ Controls that are disabled in Auto Mode

Certain controls of this unit may be disabled in Auto Mode. Controls to be disabled vary by the [AUTO SW] menu settings.

Conditions that disable controls	Controls that are disabled in Auto Mode
[A.IRIS] is set to [ON].	Iris Ring, IRIS button
[AGC] is set to [ON].	GAIN button, the USER button to which [SUPER GAIN] is registered
[AUTO SHUTTER] is set to [ON].	SHUTTER button
[ATW] is set to [ON].	WHITE BAL button
[AF] is set to [ON].	Focus ring, FOCUS ASSIST button, FOCUS A/M/ ∞ switch, PUSH AUTO button, the USER button to which [FOCUS ASSIST 1], [FOCUS ASSIST 2], [PUSH AUTO] or [FOCUS TRANS] is registered



Adjusting the Picture Quality

You can set the picture quality of images to be recorded in the main menu → [SCENE FILE].

Detail function

This function thickens or weakens the outlines of images. It effectively softens or sharpens images, but in some cases, the whole image may become rough due to emphasized noise and edges. To avoid such problems, it is necessary not to add this effect on parts where emphasizing is not needed and keep the details of the parts.

■ Menu item

[MASTER DETAIL]:	Adjusts the degree of overall outline correction in images. (→ 154)
[DETAIL CORING]:	Adjusts the detail noise removal level. (→ 154)
[SKIN TONE DTL]:	Makes skin colors appear softer for a more attractive appearance. (→ 154)
[V DETAIL LEVEL]:	Adjusts the degree of vertical outline correction in images. (→ 154)

Skin tone function

This function makes human skin look smoother in images.

■ Menu item

[SKIN TONE DTL] (→ 154)

RB gain control function

When the White Balance mode is set to [Ach] or [Bch], this function enhances or reduces the intensity of red and blue. It works in combination with Auto White Balance.

- It does not work when the White Balance mode is set to [ATW], [P3200K], [P5600K], or [VAR].

■ Menu item

[RB GAIN CONTROL SETTING] (→ 155)

Chroma setting function

This function sets color saturation and phase. It applies effects on whole images. It cannot be set to individual color hue.

■ Menu item

[CHROMA LEVEL]:	Adjusts the color density. (→ 156)
[CHROMA PHASE]:	Adjusts the color balance. (→ 156)

Color correction function

This function sets color saturation and phase. It applies individual effect on 16 phases in an image. It can be set to individual color hue.

■ Menu item

[COLOR CORRECTION SETTING] (→ 157)

Black control function

This function sets the black level that is to be the reference of luminance.

■ Menu item

[MASTER PED] (→ 158)

Gamma function

This function optimizes the tone of images.

■ Menu item

[GAMMA MODE]: Sets the optimal tone and contrast of images for the scene to be recorded. (→ 158)

[BLACK GAMMA]: Sets the gamma curve for dark areas.(→ 158)

Knee function

This function sets the compression of video signals to prevent white saturation in images.

■ Menu item

[KNEE MODE]: Sets the compression level of highly bright image signals received by the image sensor to minimize white saturation. (→ 159)

[KNEE MASTER POINT]: Adjusts the knee point position in 0.5% steps. (→ 159)

[KNEE MASTER SLOPE]: Sets the knee inclination. (→ 159)



Using the zoom

The unit can deliver a maximum optical zoom of 20 \times .

- (When the picture size of [REC FORMAT] ([→ 162](#)) is 1920 \times 1080 or below)
It can zoom up to approx. 30 \times when the [i.Zoom] is set to [ON]. ([→ 50](#))
- You can check the zoom magnification on-screen, displayed as a value between Z00 and Z99.
The value gets larger as you zoom in, and smaller as you zoom out.
- You can change the unit of the on-screen zoom magnification display by changing the [ZOOM DISPLAY] setting in the [DISP SETUP] menu. You can also change the setting so that the on-screen display does not appear. ([→ 194](#))
- When [FOCUS MACRO] is set to [OFF], subjects at a distance of approximately 1.0 m to infinity can be brought into focus. When [FOCUS MACRO] is set to [ON] and the zoom position is at the W end, subjects at a distance of approximately 10 cm to infinity can be brought into focus. ([→ 104, 173](#))

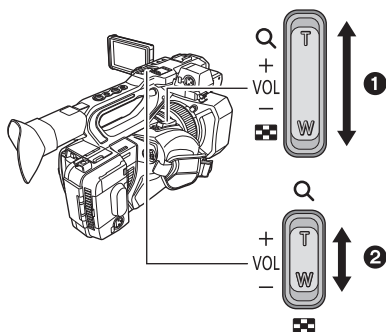

Zoom lever ①/Sub zoom lever ②

T side:

Close-up recording (zoom in)

W side:

Wide-angle recording (zoom out)

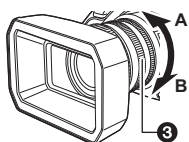

Zoom ring ③

A side:

Wide-angle recording (zoom out)

B side:

Close-up recording (zoom in)

- If you take your finger off the zoom lever during zoom operation, the operation sound may be recorded. When returning the zoom lever to the original position, move it quietly.
- The zoom magnification is maintained even after this unit is turned off.

Using the i.Zoom

When [i.Zoom] is set to [ON], you can zoom in while maintaining the beauty of high-definition picture quality up to a magnification of approx. 30×.

- Set [REC FORMAT] to a setting with a picture size of 1920×1080 or below. (→ 162)

Select the menu.

 : [SW SETUP] → [i.Zoom] → [ON]

- You can also use i.Zoom by registering [i.ZOOM] to a USER button. (→ 104)
- The zoom magnification display will change.
(Example)
 - iZ00 to iZ99: magnification levels that fall in the optical zoom range
 -  Z99: i.Zoom

● This function is not available in the following cases:

- During Super Slow Recording (→ 105)
- In Variable Frame Rate Mode (→ 102)
- When the size in [REC FORMAT] is set to 4K (4096×2160) or UHD (3840×2160)
- During Freeze Frame (→ 91)

Using Fast Zoom

When [FAST ZOOM] is set to [ON], you can use Fast Zoom while operating the zoom with the zoom lever.

1 Select the menu.

 : [SW SETUP] → [FAST ZOOM] → [ON]

2 Push the zoom lever fully to operate the zoom.

- The zoom magnification display changes when using Fast Zoom. (Example: )

■ About the zoom speed

- The zoom speed will vary depending on how far the zoom lever is pressed or how fast the zoom ring is rotated.
- The zoom operation using the sub zoom lever will be performed at a constant speed. Zoom speed of the sub zoom lever will vary depending on the setting of [SUB ZOOM]. (→ 175)

● You can also use Fast Zoom by registering [FAST ZOOM] to a USER button. (→ 84)

- The sound of the zoom mechanism becomes louder than usual during fast zoom operation. This may cause the sound to be recorded during recording.
- Depending on the subject, Auto Focus may not track it when Fast Zoom is in use.

Utilizing the USER button

Digital Zoom can be used by registering [D.ZOOM] to a USER button. (→ 89)

- Please refer to page 84 for details about setting the USER button.



Image Stabilizer Function

Use the Image Stabilizer to reduce the effects of shake during recording.

This unit is equipped with Hybrid Optical Image Stabilizer.

Hybrid Optical Image Stabilizer is a hybrid of Optical and Electrical Image Stabilizer.

1 Register [O.I.S.] to a USER button. (→ 84)

- This function is registered to the USER6 button by default.

2 Press the USER button to which [O.I.S.] is registered or touch the applicable USER button icon to switch the Image Stabilizer on/off.

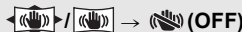

- You can also access this function by selecting menu items.

[SW SETUP] → [O.I.S.] → [ON]/[OFF]

- When [HYBRID O.I.S.] is [ON], is displayed. When [OFF], is displayed.
- This item cannot be set during Freeze Frame (→ 91)

■ Changing Image Stabilizer Mode

Select the menu.

MENU : [SW SETUP] → [HYBRID O.I.S.] → [ON] or [OFF]

When set to [ON], you can further improve image stabilization for holding the unit and recording a distant subject with zoom.

- Optical Image Stabilizer will be disabled and the setting cannot be changed in the following cases:
 - When Optical Image Stabilizer is set to (setting canceled)
 - When the size is set to 4K (4096×2160) or UHD (3840×2160) in [REC FORMAT] (→ 162)
 - During Super Slow Recording (→ 105)
 - In Variable Frame Rate Mode (→ 102)
- The setting cannot be changed during Freeze Frame (→ 91)

- Stabilization may not be possible under strong shaking conditions.
- When using a tripod, we recommend that you set the Image Stabilizer to (setting canceled).

Customizing the Image Stabilizer for various recording conditions

You can customize the Image Stabilizer by adjusting the [BLUR AMPLITUDE] and [BLUR FREQUENCY] settings individually.

■ Custom Optical Image Stabilizer

When [ON] is selected, the Image Stabilizer works with customized [BLUR AMPLITUDE] and [BLUR FREQUENCY] settings.

Select the menu.

MENU : [SW SETUP] → [CUSTOM O.I.S.] → [ON]

- The setting is fixed to [OFF] in the following case:
 - When the size in [REC FORMAT] is set to 4K (4096×2160) (→ 162)

■ Blur amplitude

You can adjust the performance of camera shake correction according to the level of camera shake during recording.

Select the menu.

 : [SW SETUP] → [BLUR AMPLITUDE] → desired setting

[1]/[2]/[3]/[4]/[5]

- If you set a smaller value, correction performance against minor camera shake will be enhanced. Even though smaller values allow more effective screen stabilization in situations with minor camera shake, such as when you are recording from a fixed position, they are less effective for correcting significant camera shake. We recommend setting a smaller value when you keep recording the same subject, for example.
- If you set a larger value, camera shake of varying degrees ranging from minor to significant will be corrected in a balanced manner. Although larger values allow you to correct significant camera shake more effectively, the screen becomes unstable when you are recording from a fixed position. We recommend that you set a larger value in situations where images are expected to be quite blurry, such as when recording in an unstable position.

■ Blur frequency

You can change the target frequency range for camera shake correction to adjust its performance according to the recording style.

Select the menu.

 : [SW SETUP] → [BLUR FREQUENCY] → desired setting

- [1]: This enhances the correction performance against camera shake of varying degrees, ranging from slow camera shake that falls in the low frequency range to fast and subtle camera shake that falls in the high frequency range. We recommend that you select this setting when recording a subject from a fixed position without panning or tilting this unit.
- [2]: This is a standard setting which enhances the correction performance against camera shake that falls in the average-to-high frequency range. Even while adjusting the position of this unit, you can keep the resulting motion in the image look natural and maintain the correction performance.
- [3]: This mainly enhances the correction performance against fast and subtle camera shake that falls in the high frequency range while weakening the correction performance against slow camera shake that falls in the low frequency range. We recommend that you use this setting when panning or tilting this unit many times while recording.



Focus

Perform focus adjustments using the focus ring. If auto focusing is difficult due to the conditions, then use Manual Focus.

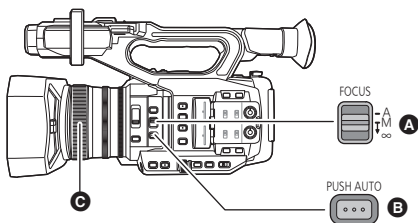

- A** FOCUS A/M/∞ switch
- B** PUSH AUTO button
- C** Focus ring

- Switch to Manual Mode. (→ 45)

1 Set the FOCUS A/M/∞ switch to [M] to enable Manual Focus.

- It will switch to MF from AF.

2 Adjust the focus by rotating the focus ring.

- The focus value can be set from MF00 (Focus distance*: approximately 10.0 cm [When [FOCUS MACRO] (→ 104, 173) is set to [ON]]) to MF99 (Focus distance*: infinity). The larger the focus value gets, the further the position where focus is achieved.

* Focus distance refers to the minimum distance where a subject can be brought into focus.

- If you move the FOCUS A/M/∞ switch towards [∞], focus will be adjusted to MF95 on the infinity side. (The FOCUS A/M/∞ switch will return to the [M] position.)
- To return to Auto Focus, set the FOCUS A/M/∞ switch to [A], or set [AF] to [ON] and switch to Auto Mode. (→ 45)

- If you set [FOCUS MACRO] to [ON], when the distance to the subject approaches within 0.95 m approx., the unit switches to the macro range and [AF] or [MF]. (The unit may switch to the macro range even when the distance to the subject is 0.95 m or more depending on the subject.)
- Depending on the zoom magnification, this unit may fail to switch to the macro range, or go to a non-displayed focus value.
- When you perform a zoom operation in the macro range, this unit may go out of focus.
- When [AF] is set to [ON] and this unit is set to Auto Mode, auto focusing is performed regardless of the position of FOCUS A/M/∞ switch. (→ 45)
- The unit of the focus value display varies depending on the [FOCUS DISPLAY] setting in the [DISP SETUP] menu. You can also change the setting so that the on-screen display does not appear. (→ 194)

■ To change the way you adjust focus with the focus ring

Select the menu.

 : [SW SETUP] → [FOCUS RING DRIVE]

- [SPEED]:** Adjusts the focus value according to the speed at which the focus ring is rotated.
- [COARSE]:** Adjusts the focus value according to the rotational position of the focus ring. Since the operation of the focus ring results in a greater change in focus value, this setting is suitable for making rough adjustments.
- [FINE]:** Adjusts the focus value according to the rotational position of the focus ring. Since the operation of the focus ring results in a smaller change in focus value, this setting is suitable for making fine adjustments.

■ To emphasize the outline of images

Setting [EVF/LCD DETAIL] to [ON] helps you achieve focus easier by emphasizing the outlines of an image displayed on the LCD monitor and viewfinder.

You can also adjust the emphasis level or change the frequency.

- You can also enable or disable this function with the applicable USER button. (→ 93)
- These settings will not affect the images actually recorded.

 : [DISP SETUP] → [EVF/LCD DETAIL] → [ON]

Adjusting the level of [EVF/LCD DETAIL]

1 Select the menu.

 : [DISP SETUP] → [EVF/LCD PEAK LEVEL]

2 Touch  /  to adjust settings.

- You can select a value between -3 and +3.

3 Touch [EXIT] to complete the setting.

Setting the peaking frequency of [EVF/LCD DETAIL]

Select the menu.

 : [DISP SETUP] → [EVF/LCD PEAK FREQ.] → [HIGH] or [LOW]

- [EVF/LCD DETAIL] is canceled in following cases:
 - If you use Focus Assist (peaking) (→ 57)

Customizing Auto Focus for various recording conditions

You can customize Auto Focus for various recording conditions by adjusting the settings of [AF SPEED], [AF SENSITIVITY], and [AF AREA WIDTH] individually.

■ Custom AF function

When [ON] is selected, Auto Focus works with customized [AF SPEED] and [AF SENSITIVITY] settings.

- **Switch to Auto Focus Mode.** (→ 53)

Select the menu.

 : [SW SETUP] → [CUSTOM AF] → [ON]

■ AF speed setup

You can change the focus speed of Auto Focus.

- **Switch to Auto Focus Mode.** (→ 53)
- **Set [CUSTOM AF] to [ON].**

1 Select the menu.

 : [SW SETUP] → [AF SPEED]

2 Touch  /  to adjust settings.

- You can select a value between -5 and +5.
- The larger the value is, the faster the focus speed will become. Conversely, the smaller the value is, the slower the focus speed will become.

3 Touch [EXIT] to complete the setting.

■ AF Sensitivity setup

You can enhance the stability or tracking performance of Auto Focus.

- **Switch to Auto Focus Mode.** (→ 53)
- **Set [CUSTOM AF] to [ON].**

1 Select the menu.

 : [SW SETUP] → [AF SENSITIVITY]

2 Touch  /  to adjust settings.

- You can select a value between 0 and 10.
- Setting a larger value will enhance the tracking performance of focus, making it easier to move focus between subjects at varying distances from this unit. We recommend that you set a larger value to keep focus on a fast-moving subject.
- Setting a smaller value will provide more stability to focus, making it easier to keep focus on the targeted subject even when an intervening object passes in front of the camera or the subject disappears from the view of this unit. We recommend that you set a smaller value to avoid bringing an intervening object or the background into focus.

3 Touch [EXIT] to complete the setting.

● This function is not available in the following cases:

- In manual focus mode (→ 53)
 - During Super Slow Recording (→ 105)
 - In Variable Frame Rate Mode (→ 102)
- When a faster [AF SPEED] value is selected, focus mechanism noise will be more audible. As a result, the noise may be recorded while recording is in progress.

■ AF Area Width Adjustment

You can adjust the effective area width for Auto Focus according to the size of the subject.

- **Switch to Auto Focus Mode.** (→ 53)

1 Select the menu.

 : [SW SETUP] → [AF AREA WIDTH] → [SET]

2 Push the jog dial.



3 Rotate the jog dial to adjust the AF area frame.

- A** [RETURN]
- B** AF area frame
- C** [EXIT]

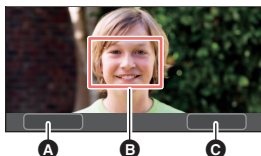

4 Touch [EXIT] to complete the setting.

- [AF-AREA] will be displayed on the screen.

- To cancel the settings, set [AF AREA WIDTH] to [OFF].
- If you push the jog dial in Step 2, the AF area frame turns yellow, allowing you to select [RETURN]/[EXIT] by rotating the jog dial. Push the jog dial to set the selected item.
- You can also adjust AF area width by registering [AF AREA] to a USER button. (→ 101)
- This function is not available in the following cases:
 - In manual focus mode (→ 53)
 - When using Area Mode (→ 92)
 - During Freeze Frame (→ 91)

One Push AF

If you press the PUSH AUTO button in Manual Focus Mode, the camera performs high-speed focusing until the image is focused.

- **Switch to Manual Focus Mode.** (→ 53)

Press PUSH AUTO button.

- Auto Focus will be activated and the camera will perform high-speed focusing until the image is focused.
 - The focus setting returns to Manual Focus Mode once the image is focused or a certain time has elapsed.
-
- You can also use One Push AF with the USER button to which [PUSH AUTO] is registered. (→ 84)
 - One Push AF does not work in following cases:
 - When Auto Focus is used

Push AF

If you press and hold the PUSH AUTO button, Manual Focus will be temporarily switched to Auto Focus.

- **Set this unit to Manual Focus. (→ 53)**

Press and hold the PUSH AUTO button.

- The focus position will be automatically adjusted for the subject at the center of the screen.
- If you set [AREA MODE] to [FOCUS], [FOCUS/IRIS] or [FOCUS/Y GET] and use Area Mode, the focus position will be automatically adjusted to the subject you have touched. (→ 92)
- It will be canceled when the button is released, and the focus position set by the Push AF will be maintained.

- You can also use Push AF with the USER button to which [PUSH AUTO] is registered. (→ 84)
- Push AF does not work in following cases:
 - When Auto Focus is used

Focus Assist

You can use Focus Assist by pressing the FOCUS ASSIST button or the USER button to which [FOCUS ASSIST 1] or [FOCUS ASSIST 2] is registered.

- For information on how to set the USER buttons, refer to page 84.

Selecting a Focus Assist method

- **To select the Focus Assist method for the FOCUS ASSIST button or the USER button to which [FOCUS ASSIST 1] is registered**

Select the menu.

 : [SW SETUP] → [FOCUS ASSIST 1] → desired setting

[EXPAND]:	Magnifies the central area of the screen when Focus Assist is used.
[PEAKING]:	Highlights in-focus portions with color when Focus Assist is used.
[BOTH]:	Sets both [EXPAND] and [PEAKING].

- **To select the Focus Assist method for the USER button to which [FOCUS ASSIST 2] is registered**

Select the menu.

 : [SW SETUP] → [FOCUS ASSIST 2] → desired setting

[EXPAND] / [PEAKING]

- You can use the magnified display and the peaking function separately or use them in combination by selecting different settings for [FOCUS ASSIST 1] and [FOCUS ASSIST 2].
- If [FOCUS ASSIST 1] is set to [BOTH], [FOCUS ASSIST 2] is not available. In addition, the USER button to which [FOCUS ASSIST 2] is registered is disabled.

Using Focus Assist

- Switch to Manual Focus Mode. (→ 53)

Press the **FOCUS ASSIST** button or the **USER** button to which **[FOCUS ASSIST 1]** or **[FOCUS ASSIST 2]** is registered.

- You can also use Focus Assist by touching the **USER** button icon to which **[FOCUS ASSIST 1]** or **[FOCUS ASSIST 2]** is registered.
- To turn off Focus Assist, perform the following operations:
 - Press the **FOCUS ASSIST** button or the **USER** button again, or touch the **USER** button icon again.
 - Touch **[EXIT]**.

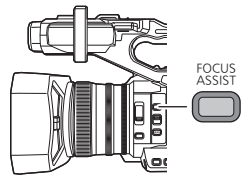

■ To adjust the magnified display

If you set Focus Assist to ON by following either of the procedures below, the central area of the screen will be magnified. You can change the magnification and position of the magnified display.

- Setting the menu item **[FOCUS ASSIST 1]** to **[EXPAND]** or **[BOTH]** and pressing the **FOCUS ASSIST** button or the **USER** button to which **[FOCUS ASSIST 1]** is registered.
- Setting the menu item **[FOCUS ASSIST 2]** to **[EXPAND]** and pressing the **USER** button to which **[FOCUS ASSIST 2]** is registered.
- You can also change the magnification level of the magnified display using the jog dial.

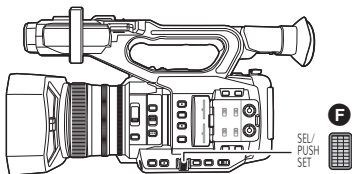
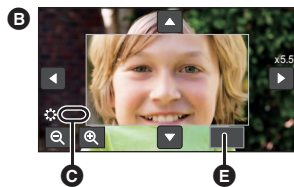
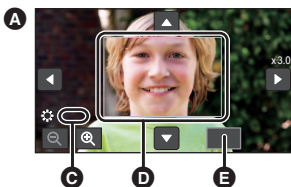

- A 3×–5× display
- B 5.5×–10× display
- C **[ASSIST]**
- D Magnified display
- E **[EXIT]**
- F Jog dial

(To change the magnification level)

Touch / or rotate the jog dial to change the magnification level.



: Increases the magnification level by 0.5×.

: Decreases the magnification level by 0.5×.

- You can adjust the magnification from 3× to 10×.

(Moving the magnified area)

Touch / / / or slide the screen while touching it to move the magnified area.

■ To change the peaking settings

If you set Focus Assist to ON by following either of the procedures below, in-focus portions are highlighted with color (peaking).

- Setting the menu item [FOCUS ASSIST 1] to [PEAKING] or [BOTH] and pressing the FOCUS ASSIST button or the USER button to which [FOCUS ASSIST 1] is registered.
- Setting the menu item [FOCUS ASSIST 2] to [PEAKING] and pressing the USER button to which [FOCUS ASSIST 2] is registered.

G: Peaking

- You can set the peaking color and strength.

(When changing the peaking color)

Select the menu.

 : [SW SETUP] → [PEAKING COLOR] → desired color

[Red]/[Blue]/[Yellow]/[White]

(When setting the peaking strength)

1 Select the menu.

 : [SW SETUP] → [PEAKING LEVEL] → desired setting

2 Touch  /  to adjust settings.

- You can select a value between -7 and +7.

3 Touch [EXIT] to complete the setting.

(Notes on Focus Assist)

- Focus Assist is not possible in following cases:
 - During Recording Check (→ 90)
 - During Freeze Frame (→ 91)
 - When color bars are displayed (→ 108)
- Focus Assist is canceled in following cases:
 - If you turn the unit off
 - (If you operate the FOCUS ASSIST button or the USER button to which [FOCUS ASSIST 1] is registered)
When the setting of [FOCUS ASSIST 1] (→ 57) is changed
 - (If you operate the USER button to which [FOCUS ASSIST 2] is registered)
When the setting of [FOCUS ASSIST 2] (→ 57) is changed
 - When you set this unit to Auto Focus
 - When you press the USER button to which [FOCUS TRANS] is registered or touch the applicable USER button icon (→ 62)
- The magnified display and peaking are not displayed on recorded images.
- The magnified display and peaking are not displayed on an external monitor.
- Freeze Frame is not available when you use Focus Assist. (→ 91)



- Peaking may not be displayed when you use Digital Zoom (→ 89). To zoom in and use peaking at the same time, we recommend increasing the magnification level of the magnified display by setting [FOCUS ASSIST 1] to [BOTH] or by using the magnified display and the peaking function in combination.

(Notes on the peaking of Focus Assist)

- When EVF/LCD detail is enabled, Focus Assist is canceled. (→ 54)

(Notes on the magnified display of Focus Assist)

- Some information on the screen disappears when the screen is magnified.
- In the following cases, the screen is not magnified during Focus Assist:
 - During motion picture recording or PRE-REC (→ 97, 184)
 - When using Digital Zoom
 - When using Area Mode (→ 92)
 - During auto recording (→ 100)
 - During Super Slow Recording (→ 105)
 - In Variable Frame Rate Mode (→ 102)
 - During AG ROP application connection (→ 143)
- If you set the magnification level of the magnified display to 5.5× or higher, peaking may not be displayed when using i.Zoom (→ 49).

Manual Focus Assist

Focus is automatically adjusted after you adjust it with the focus ring in Manual Focus Mode.

- Focus may not be achieved when the focus deviation is great.
- After automatic adjustment is complete, the focus is not adjusted automatically again until you operate the focus ring.
- **Switch to Manual Focus Mode.** (→ 53)

1 Select the menu.

 : [SW SETUP] → [MF ASSIST] → [ON]

- Touch [EXIT] to complete the setting.
- The on-screen icon changes from [MF] to [MA].

2 Adjust the focus by rotating the focus ring.

- Focus is automatically adjusted after you adjust it with the focus ring.
- The color of the on-screen icon for the focus value changes during automatic adjustment.

- This function is not available in the following cases:
 - When Auto Focus is used
 - During Super Slow Recording (→ 105)
 - In Variable Frame Rate Mode (→ 102)
- The on-screen icon changes to  in the macro range.
- Manual focus assist does not work in following cases:
 - When adjusting the focus with the remote control (commercially-available) (→ 127)

Focus Transition

You can use Focus Transition by registering [FOCUS TRANS] to a USER button. With Focus Transition, you can shift the current focus position to a pre-registered focus position.

- Please refer to page 84 for details about setting the USER button.

Registering a focus position

To use Focus Transition, you need to register a focus position.

- You can register up to 3 focus positions.
- **Switch to Manual Focus Mode.** (→ 53)

1 Select the menu.

 : [RECORD SETUP] → [FOCUS TRANSITION] → [SET]

2 Touch the item to which you want to register the focus position.

[1]/[2]/[3]

- You can select the item by pressing the USER buttons 1–3.
- The Focus Assist screen will be displayed.
- The screen may not be magnified depending on your settings.

3 Adjust the focus by rotating the focus ring.

4 Touch [ENTER].

- The icon of the item to which the focus position has been registered will be highlighted in yellow.
- To select a different item, perform the operations in Steps 2–4.

5 Touch [EXIT] to complete the setting.

- The focus positions of the items you have set will be registered.

-
- This function is not available in the following cases:
 - When Auto Focus is used
 - During Freeze Frame (→ 91)
 - During Super Slow Recording (→ 105)
 - In Variable Frame Rate Mode (→ 102)
 - The focus position settings are canceled in the following cases:
 - If you turn the unit off
 - If you press the THUMBNAIL button
 - If you operate the zoom
 - If you enable or disable Infrared Recording Mode

To set the Focus Transition time

1 Select the menu.



 : [RECORD SETUP] → [FOCUS TRANSITION TIME]

2 Touch the desired setting item.

[DIRECT]/[FASTEST]/[2-15 SEC.]/[20 SEC.]/[30 SEC.]/[45 SEC.]/[60 SEC.]/[90 SEC.]

- If you select [DIRECT], the focus position changes as soon as Focus Transition starts, but the operating noise of the lens may be recorded.

3 (If you have selected [2-15 SEC.] in Step 2)

Touch  /  to set the duration.

- You can set a Focus Transition time of 2–15 seconds (by 0.5 second increments).
- Touch [RETURN].

4 Touch [EXIT] to complete the setting.

To start Focus Transition and recording simultaneously

You can start Focus Transition and recording simultaneously by enabling [FOCUS TRANSITION REC].

1 Select the menu.

 : [RECORD SETUP] → [FOCUS TRANSITION REC]

2 Touch the item.

[1]/[2]/[3]

3 Touch [EXIT] to complete the setting.

4 When the recording screen is displayed, press the USER button to which [FOCUS TRANS] is registered or touch the applicable USER button icon.

5 Press the recording start/stop button or the USER button to which [AUTO REC] is registered.

- Recording and Focus Transition will start simultaneously. Focus will shift to the position you have set in Step 2.

To set the length of time before Focus Transition starts

Select the menu.

 : [RECORD SETUP] → [FOCUS TRANSITION WAIT] → desired time

[0 SEC.]/[5 SEC.]/[10 SEC.]



White Balance

Automatic White Balance function may not reproduce natural colors depending on the scenes or lighting conditions. If so, you can adjust the White Balance manually.

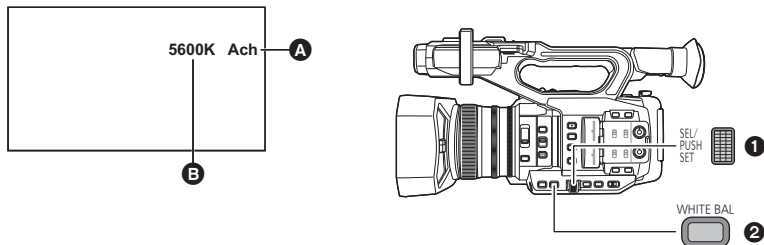

A White Balance

B Color temperature display

- Displayed when the White Balance mode is set to Ach or Bch.
- The color temperature display is not guaranteed to indicate an exact value. Use the indicated value only as a guide.

1 Jog dial

2 WHITE BAL button

• Register [AWB] to a USER button. (→ 84)

This function is registered to the USER9 button by default.

• Switch to Manual Mode. (→ 45)

1 Press the WHITE BAL button to switch to [Ach], [Bch], or [PRST].

- The setting changes each time you press the button.
[Ach] → [Bch] → [PRST]
- If you switch to [PRST], the White Balance mode set in [WB PRESET] will be displayed.

2 (If you have switched to [PRST])

Press the USER button to which [AWB] is registered or touch the applicable USER button icon to change the White Balance mode.

- The mode will change each time you press the USER button to which [AWB] is registered or touch the applicable USER button icon.
[P3200K] → [P5600K] → [VAR]
- It is not possible to change the White Balance mode without registering [AWB] to a USER button.

- If you set the White Balance mode to [ATW] in by following either of the procedures below, the White Balance mode cannot be changed even if you press the USER button to which [AWB] is registered or touch the applicable USER button icon.
 - Pressing the USER button to which [ATW] is registered (→ 84, 89)
 - Pressing the WHITE BAL button to switch to the item (Ach/Bch/PRST) setting in [ATW SET] (→ 171)

About White Balance modes

Display (Mode)	Settings
ATW (ATW)^{*1}	It will automatically adjust in accordance with the recording condition.
LOCK (ATW Lock)^{*2}	It will lock the setting for ATW. (→ 66)
P3200K (P3200K)	Preset value for studio/indoor recording (halogen lamp, etc.)
P5600K (P5600K)	Preset value for outdoors
VAR (VAR)	Setting can be finely adjusted in accordance to the recording conditions. (→ 67)
Ach (Ach)	Setting can be optimized for the scene to be recorded when you press the WHITE BAL button to switch to [Ach]. (→ 67)
Bch (Bch)	Setting can be optimized for the scene to be recorded when you press the WHITE BAL button to switch to [Bch]. (→ 67)

*1 This setting is selected automatically when one of the following operations is performed:

- Set [ATW] to [ON] and switch to Auto Mode. (→ 45)
- Press the USER button to which [ATW] is registered. (→ 84, 89)
- Pressing the WHITE BAL button to switch to the item (Ach/Bch/PRST) setting in [ATW SET] (→ 171)

*2 You can enable this mode by pressing the USER button to which [ATW LOCK] is registered.

- In the following cases, even if you press the USER button to which [ATW] is registered or press the WHITE BAL button, the White Balance mode cannot be changed:
 - In Auto Mode with [ATW] set to [ON]
 - During Freeze Frame (→ 91)
- Changing the settings in [RB GAIN CONTROL SETTING] allows you to fine-adjust the color balance settings of [Ach] and [Bch]. (→ 155)



Customizing ATW for various recording conditions

You can customize the ATW settings for various recording conditions by adjusting the settings of [ATW TARGET R] and [ATW TARGET B] individually.

■ Fine-adjusting the color balance of ATW

1 Select the menu.

 : [SW SETUP] → [ATW TARGET R] or [ATW TARGET B]

- [ATW TARGET R] adjusts the intensity of red.
 - [ATW TARGET B] adjusts the intensity of blue.
- 2 Touch  /  to adjust settings.
- You can select a value between -10 and +10.
- 3 Touch [EXIT] to complete the setting.

To set ATW Lock

You can set ATW Lock by registering [ATW LOCK] to a USER button.

- Please refer to page 84 for details about setting the USER button.

1 Set the White Balance mode to [ATW].

2 Press the USER button to which [ATW LOCK] is registered or touch the applicable USER button icon.

- To cancel ATW Lock, press the USER button or touch the USER button icon again. Canceling ATW Lock will return the White Balance mode back to [ATW].

-
- This function is not available in the following cases:
 - When the White Balance mode is set to something other than [ATW]
 - It will be canceled when the unit is turned off.

To finely adjust the White Balance

Setting the White Balance mode to [VAR] allows you to set a White Balance value between 2000K and 15000K.

- Use the jog dial to change the settings.
- **Switch to Manual Mode.** (→ 45)

- 1 **Set the White Balance mode to [VAR].** (→ 64)
- 2 **Rotate the jog dial to adjust the color balance.**



- 3 **Push the jog dial to finish the adjustment.**



-
- You can also access this setting by selecting menu items.
[SW SETUP] → [WB VAR] (→ 172)
 - The set value is not guaranteed to be an exact value. Use it only as a guide.

To set the White Balance in accordance to the recording scene

- **Register [AWB] to a USER button.** (→ 84)

- 1 **Fill the screen with a white subject or place a white piece of paper in front of the lens.**
- 2 **Press the WHITE BAL button to switch to [Ach] or [Bch].**
- 3 **Press the USER button to which [AWB] is registered or touch the applicable USER button icon to set the Auto White Balance mode.**

- Adjust the Black Balance first, and then the White Balance. The screen goes dark momentarily, "WB SET OK" is displayed, and the adjustment ends.
 - If you have pressed the USER button to which [AWB] is registered or touched the applicable USER button icon, only the White Balance is adjusted. When "WB SET OK" is displayed, the adjustment is complete.
-
- When the White Balance mode is set to a setting other than [Ach] or [Bch], if you press and hold the USER button to which [AWB] is registered or touch and hold the applicable USER button icon while recording is paused, Auto Black Balance will operate. Setting is completed when the screen goes black momentarily and "BB SET OK" is displayed.
 - When the Auto White Balance/Auto Black Balance cannot be performed, an error message "WB SET NG" or "BB SET NG" is displayed on the screen. In such case, use other mode.
 - It is not possible to operate Auto White Balance or Auto Black Balance without registering [AWB] to a USER button.
 - The contents previously set are maintained in the [Ach] or [Bch]. Perform the setting again when the recording condition has changed.
 - A color temperature value that is displayed after Auto White Balance is enabled is not guaranteed to be an exact value. Use it only as a guide.



iris/Gain adjustment

When recording a scene that is too dark (or bright) or a scene in a similar situation, manually adjust the iris and gain.

iris adjustment

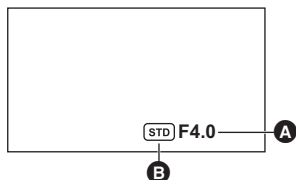

- A** Iris value
- B** Auto iris icon*

* It is displayed in Auto Iris Mode.

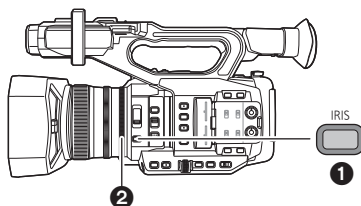

- 1** IRIS button
- 2** Iris ring

- Switch to Manual Mode. (→ 45)

1 Press the IRIS button to switch to Manual Iris Mode.

- **STD** disappears.

2 Adjust the iris by rotating the iris ring.

Iris value:

CLOSE ↔ (F11 to F3.0) ↔ **OPEN**

- Value closer to CLOSE darken the image.
- Value closer to OPEN brighten the image.
- To return to Auto Iris Mode, press the IRIS button, or set [A.IRIS] to [ON] and switch to Auto Mode. (→ 45)

-
- This item cannot be set during Freeze Frame. (→ 91)
 - Depending on the zoom magnification, there are iris values that are not displayed.
 - In Auto Gain Mode or Auto Shutter Mode, the screen brightness may not change even if you adjust the iris. (→ 70, 72)

Customizing Auto Iris motion settings for various recording conditions

You can customize Auto Iris motion settings for various recording conditions by adjusting the settings of [AUTO IRIS LEVEL] and [AUTO IRIS LEVEL EFFECT] individually.

■ Adjusting brightness during the Auto Iris Mode

1 Select the [AUTO IRIS LEVEL EFFECT] menu.

 : [SCENE FILE] → [AUTO IRIS LEVEL EFFECT]

2 Touch / to adjust settings.

- You can select a value between -50 and +50.
- Touch [EXIT].

3 Select the [AUTO IRIS LEVEL] menu.

 : [SCENE FILE] → [AUTO IRIS LEVEL] → [ON]

- If you select [OFF], the [AUTO IRIS LEVEL EFFECT] setting will not be applied.

4 Touch [EXIT] to complete the setting.

- You can also change the [AUTO IRIS LEVEL] setting with a USER button. (→ 99)

Utilizing the USER button

It is convenient to use following functions of the USER button when it is set to Iris adjustment.

- Please refer to page 84 for details about setting the USER button.

USER button function	Effect
[BACKLIGHT] (→ 87)	Switches to automatic iris control to compensate the backlight. This will brighten the image on the screen to prevent getting dark when a backlight is hitting the subject from the back.
[SPOTLIGHT] (→ 88)	Switches to automatic iris control for spotlight. This will allow to clearly record an extremely bright subject.

Gain adjustment

- Use the jog dial to change the settings.

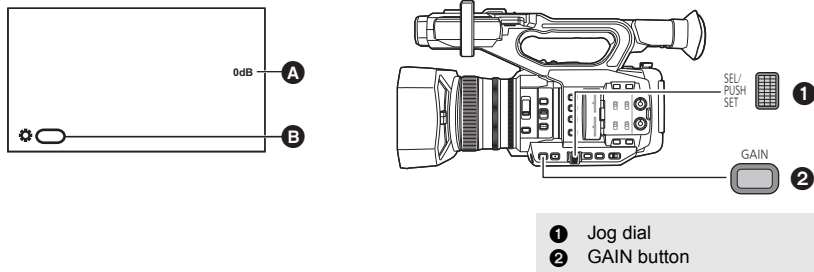

A Gain value

- In Auto Gain Mode, “AGC” is displayed; in Manual Gain Mode, the gain value is displayed in dB.
- B [GAIN]

- **Switch to Manual Mode.** (→ 45)

1 Press the GAIN button to switch to [LOW GAIN], [MID GAIN], or [HIGH GAIN].

- The setting changes each time you press the button.
[LOW GAIN] → [MID GAIN] → [HIGH GAIN]
- It is possible to register gain values to [LOW GAIN], [MID GAIN], and [HIGH GAIN] and switch between these values. (→ 169, 170)
- It is also possible to switch to the desired gain value by pressing the USER button to which [LOW GAIN], [MID GAIN] or [HIGH GAIN] is registered. (→ 107)

2 Push the jog dial.



3 Adjust the gain by rotating the jog dial.

Gain value:

0 dB to 24 dB

- Value closer to 0 dB darken the image.
- Value closer to 24 dB brighten the image.
- When [EXTENDED SENSITIVITY] is set to [ON], you can set a value between -3 dB and 24 dB. (→ 166)
- The selected gain value is not maintained if any of the following operations is performed:
 - Pressing the GAIN button
 - Switching to Auto Gain Mode
 - Switching to Infrared Recording Mode (→ 94, 184)
- Auto Gain Mode is activated when one of the following operations is performed:
 - Setting [AGC] to [ON] and switching to Auto Mode (→ 45)
 - Setting [LOW GAIN], [MID GAIN] or [HIGH GAIN] to [AUTO] and then pressing the GAIN button to switch to the applicable gain setting.



-
- It is not possible to adjust the gain value using the GAIN button and jog dial in the following situations:
 - During Freeze Frame (→ 91)
 - If the gain value is increased, the noise on the screen increases.
 - In Auto Iris Mode or Auto Shutter Mode, the screen brightness may not change even if you adjust the gain. (→ 68, 72)
 - When a negative gain value (a value between -3 dB and -1 dB) is selected, if you set [EXTENDED SENSITIVITY] to [OFF], the gain value will be set to 0 dB.

■ Changing the maximum possible gain value for Auto Gain Mode

Select the menu.

 : [AUTO SW] → [AGC LIMIT] → desired setting

[3 dB]/[6 dB]/[9 dB]/[12 dB]/[15 dB]/[18 dB]/[21 dB]/[24 dB]

Super Gain

You can use Super Gain by registering [SUPER GAIN] to a USER button.

Super Gain allows you to set the gain value to 30 dB or 36 dB.

- Please refer to page 84 for details about setting the USER button.

- **Switch to Manual Mode.** (→ 45)

Press the USER button to which [SUPER GAIN] is registered or touch the applicable USER button icon.

- To cancel Super gain, press the USER button or touch the USER button icon again.

■ To change the gain value of Super Gain

Select the menu.

 : [SW SETUP] → [SUPER GAIN] → desired setting

[30 dB]/[36 dB]

-
- Super Gain is not available in the following cases:
 - In Auto Gain Mode
 - During Freeze Frame (→ 91)
 - In High-sensitivity Recording Mode (→ 167)
 - Super Gain will be canceled if you set [HIGH SENS. MODE] to [HIGH SENS.].



Manual shutter speed

Adjust the shutter speed when recording fast-moving subjects.

- Use the jog dial to change the settings.

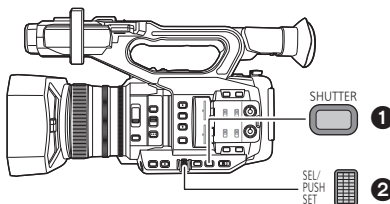

- A** Shutter speed
- B** Auto Shutter display
 - This is displayed in Auto Shutter Mode.
- C** [SHUTTER]

- 1** SHUTTER button
- 2** Jog dial

- Switch to Manual Mode. (→ 45)

1 Press the SHUTTER button to switch to Manual Shutter Mode.

2 Adjust the shutter speed by rotating the jog dial.

- To return to Auto Shutter Mode, press the SHUTTER button, or set [AUTO SHUTTER] to [ON] and switch to Auto Mode. (→ 45)



Shutter speed:

The shutter speed varies depending on the frame rate in [REC FORMAT]. (→ 162)

Frame rates	Shutter speed
59.94p/59.94i	1/60.0* ↔ 1/2 ↔ 1/4 ↔ 1/8 ↔ 1/15 ↔ 1/30 ↔ 1/60 ↔ ... 1/8000
29.97p	1/60.0* ↔ 1/2 ↔ 1/4 ↔ 1/8 ↔ 1/15 ↔ 1/30 ↔ 1/50 ↔ ... 1/8000
50.00p/50.00i/25.00p	1/50.0* ↔ 1/2 ↔ 1/3 ↔ 1/6 ↔ 1/12 ↔ 1/25 ↔ 1/50 ↔ ... 1/8000
23.98p/24.00p	1/48.0* ↔ 1/2 ↔ 1/3 ↔ 1/6 ↔ 1/12 ↔ 1/24 ↔ 1/48 ↔ ... 1/8000

* Synchro Scan values (→ 74)

- The shutter speed closer to 1/8000 is faster.

■ Shutter speed guide for fast moving subjects

Refer to the table below to reduce afterimages that appear when playback is paused.

Subject	Shutter speed
Golf or tennis shot	1/500 to 1/2000
Roller coaster	1/500 to 1/1000

-
- The shutter speed cannot be adjusted in the following cases:
 - During Freeze Frame (→ 91)
 - You may see a band of light around an object that is shining very bright, or highly reflective.
 - During normal playback, image movement may not look smooth.
 - If you record an extremely bright object or record under indoor lighting, color and screen brightness may change or a horizontal line may appear on the screen. In such cases, change settings as follows:
 - Set this unit to Auto Shutter Mode.
 - Adjust the shutter speed to 1/50, 1/60 or 1/100.
 - Adjust the Synchro Scan setting
 - In Auto Iris Mode or Auto Gain Mode, the screen brightness may not change even if you adjust the shutter speed. (→ 68, 70)
 - When the shutter speed setting is slow, this unit may not be able to keep up with changes in the image. In such a case, set the iris, focus, and White Balance mode to manual settings.

Making adjustments with Synchro Scan

If you press the jog dial when the shutter speed is displayed as a decimal number, the Synchro Scan setting will be displayed. You can fine-adjust the shutter speed by adjusting the Synchro Scan setting. This will minimize flickering and horizontal bars in images.

1 Press the SHUTTER button.

2 When the shutter is displayed as a decimal number (e.g., 1/60.0), press the jog dial.

- The display on the screen will switch from [⚙️ SHUTTER] to [⚙️ SYNCHRO], and the Synchro Scan setting will be displayed.



3 Adjust the Synchro Scan setting by rotating the jog dial.

- To minimize flickering and horizontal bands, look at the screen while adjusting the shutter speed.

4 Push the jog dial to set.

- The set shutter speed will also be applied to the [SYNCHRO SCAN] menu setting. (→ 153)

Shutter speed range for the Synchro Scan setting

Depending on the size and frame rate in [REC FORMAT], the range of available shutter speeds varies. (→ 162)

Frame rates	Shutter speed
59.94p/59.94i	1/60.0 to 1/249.7
29.97p	1/30.0 to 1/249.7
23.98p	1/24.0 to 1/249.6
24.00p	1/24.0 to 1/249.9
50.00p/50.00i	1/50.0 to 1/250.0
25.00p	1/25.0 to 1/250.0



Audio Input

This unit can record audio in 2 ch.

It is possible to switch between built-in microphone, external microphone, or connected audio equipment for each channel.

■ About audio recording methods

The audio recording method varies depending on the [REC MODE] setting. (→ 161)

Recording mode	Audio recording method
MOV	Linear PCM (LPCM)
MP4	
AVCHD	Dolby Digital

Switching Audio Input

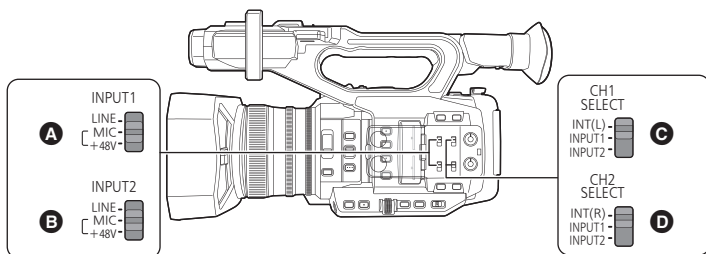

- A** INPUT1 switch
- B** INPUT2 switch
- C** CH1 SELECT switch
- D** CH2 SELECT switch

■ Using the built-in microphone

Audio is recorded with the built-in microphone (2 ch) when the CH1 SELECT switch is set to INT(L) and the CH2 SELECT switch is set to INT(R).

■ Using an external microphone or audio equipment

- 1** Connect an external microphone or audio equipment to AUDIO INPUT1, 2 terminals (XLR 3 pin). (→ 23)

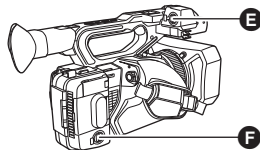

- E** AUDIO INPUT1 terminal (XLR 3 pin)
- F** AUDIO INPUT2 terminal (XLR 3 pin)

2 Use INPUT1 or INPUT2 switches to switch the connected audio input signal.

LINE^{*1}: Audio equipment is connected

MIC^{*2}: An external microphone is connected

+48V^{*2}: When using a phantom microphone (which requires a power supply of +48 V)

*1 The input level varies depending on the [INPUT1 LINE LEVEL] or [INPUT2 LINE LEVEL] setting. (→ 188)

*2 The input level varies depending on the [INPUT1 MIC LEVEL] or [INPUT2 MIC LEVEL] setting. (→ 188)

3 Use the CH1 SELECT switch to select the input signal to be recorded to audio channel 1.

INT(L): Audio from the built-in microphone L (left) ch is recorded to audio channel 1.

INPUT1: Audio from a device connected to AUDIO INPUT1 terminal (XLR 3 pin) is recorded to channel 1.

INPUT2: Audio from a device connected to AUDIO INPUT2 terminal (XLR 3 pin) is recorded to channel 1.

4 Use the CH2 SELECT switch to select the input signal to be recorded to audio channel 2.

INT(R): Audio from the built-in microphone R (right) ch is recorded to audio channel 2.

INPUT1: Audio from a device connected to AUDIO INPUT1 terminal (XLR 3 pin) is recorded to channel 2.

INPUT2: Audio from a device connected to AUDIO INPUT2 terminal (XLR 3 pin) is recorded to channel 2.

■ Table of audio input patterns

Switch setting		Channel or terminal used for signal input	
CH1 SELECT switch	CH2 SELECT switch	Audio channel 1	Audio channel 2
INT(L)	INT(R)	built-in microphone Lch	built-in microphone Rch
	INPUT1	built-in microphone Lch	AUDIO INPUT1 terminal
	INPUT2	built-in microphone Lch	AUDIO INPUT2 terminal
INPUT1	INT(R)	AUDIO INPUT1 terminal	built-in microphone Rch
	INPUT1	AUDIO INPUT1 terminal	AUDIO INPUT1 terminal
	INPUT2	AUDIO INPUT1 terminal	AUDIO INPUT2 terminal
INPUT2	INT(R)	AUDIO INPUT2 terminal	built-in microphone Rch
	INPUT1	AUDIO INPUT2 terminal	AUDIO INPUT1 terminal
	INPUT2	AUDIO INPUT2 terminal	AUDIO INPUT2 terminal

To remove the external microphone, etc., from the AUDIO INPUT1, 2 terminals (XLR 3 pin)

Remove while pushing on the PUSH section of the AUDIO INPUT1, 2 terminals (XLR 3 pin).

- Set the input signal to built-in microphone by switching the CH1 SELECT, CH2 SELECT switches to INT (L) or INT (R) after removing the external microphone. Audio will not be recorded when motion picture is recorded without switching.

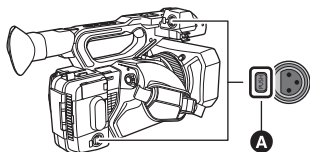

A PUSH section

- Set INPUT1, 2 switches to LINE or MIC if you connect equipment not compatible with +48 V. You can damage this unit or such equipment if you leave the setting at [+48V].
- This unit is turned off when a problem occurs with the +48 V power supply.
- The battery will discharge faster if you use a phantom microphone.
- If there is noticeable noise coming from the terminal that is not in use, set the corresponding INPUT switch (INPUT1, 2) to LINE.

Adjusting the audio input level

Selecting an adjustment method

You can set how to adjust the audio input level for each audio channel. For audio channel 1, select [AUDIO LEVEL CH1]; for audio channel 2, select [AUDIO LEVEL CH2].

1 Select the menu.

MENU : [AUDIO SETUP] → [AUDIO LEVEL CH1] or [AUDIO LEVEL CH2] → desired setting

[AUTO]: Adjusts the level automatically.

[MANUAL]: Adjusts the level manually.

2 (If you have set to [MANUAL]) Adjust the input level operating the AUDIO LEVEL CH1/AUDIO LEVEL CH2 knobs.

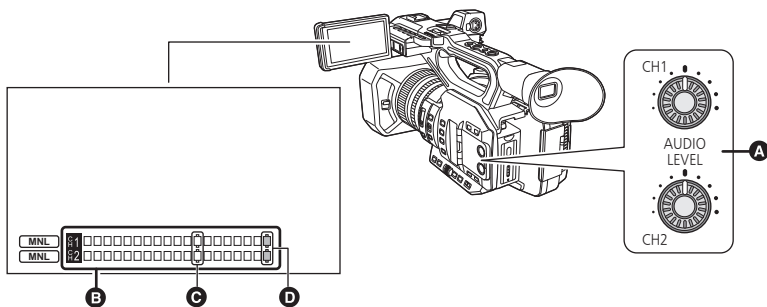

- A** AUDIO LEVEL CH1/AUDIO LEVEL CH2 knobs
- B** Audio level meter
- C** -12 dB
- D** 0 dB

- Adjust confirming the audio level meter.

Using the ALC function

ALC can reduce audio noise. For audio channel 1, select [AUDIO ALC CH1]: for audio channel 2, select [AUDIO ALC CH2].

- 1 Set [AUDIO LEVEL CH1]/[AUDIO LEVEL CH2] to [MANUAL]. (→ 77)
- 2 Select the menu.

 : [AUDIO SETUP] → [AUDIO ALC CH1] or [AUDIO ALC CH2] → desired setting

[ON]: Enables ALC, allowing you to record audio with reduced noise.

[OFF]: Allows you to record natural-sounding audio.

■ To set the ALC function to both audio channels 1 and 2

If you set [AUDIO ALC LINK] to [ON], when ALC works for either of the audio channels, it will also work for the other audio channel.

- 1 Set [AUDIO LEVEL CH1]/[AUDIO LEVEL CH2] to [MANUAL]. (→ 77)
- 2 Set [AUDIO ALC CH1]/[AUDIO ALC CH2] to [ON].
- 3 Select the menu.

 : [AUDIO SETUP] → [AUDIO ALC LINK] → [ON]

Counter display

You can change a counter display that indicates how much time has elapsed during recording or playback.

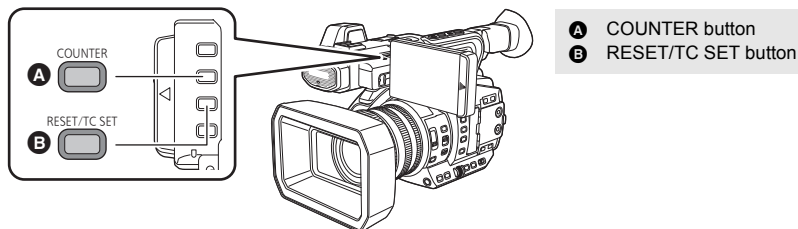

Press the COUNTER button to switch the counter display.

- The display will be switched in the following order: Time Code → User Information* → Recording Counter → Off.

Counter display	Indications
Time Code	TC 00:00:00:00 or TC 00:00:00.00 <ul style="list-style-type: none"> Display will change depending on the setting of the [DF MODE]. (→ 80)
User Information* (→ 81)	UB 00 00 00 00
Recording Counter (→ 82)	(In Recording Mode) 0:00:00 or SCN 0:00:00 (In Playback Mode) SCN 0:00:00 <ul style="list-style-type: none"> In Recording Mode, display will change depending on the setting of the [REC COUNTER]. In Playback Mode, display will return to SCN 0:00:00 for each scene.

* This is displayed only when [REC MODE] is set to [AVCHD]. (→ 161)

Setting the Time Code

Time code will display the recording time in hours, minutes, seconds, and frames.

TC 00:00:00:00 (hour : minute : second : frame [NDF])

TC 00:00:00.00 (hour : minute : second . frame [DF])

- The number of frames (frame count per second) varies depending on the frame rate in [REC FORMAT]. (→ 162)

Frame rates	Frame
59.94p/59.94i/29.97p	0 to 29
50.00p/50.00i/25.00p	0 to 24
23.98p/24.00p	0 to 23

[DF MODE]



Select the compensation mode for the time code.

- Set [SYSTEM FREQ] to [59.94Hz]. (→ 161)

Select the menu.

: [RECORD SETUP] → [DF MODE] → desired setting

[DF]:	Time code is compensated in accordance with the actual time. It is mainly used for broadcasting such as TV programs.
[NDF]:	It will not compensate the time code. (There will be a difference from the actual time)

- This item will be set to [NDF] automatically in following cases:
 - When the frame rate in [REC FORMAT] is 23.98p or 24.00p (→ 162)
 - During the Interval Recording (→ 183)
- This item will be automatically set to [NDF] and will not be displayed as a menu item when [SYSTEM FREQ] is set to [50.00Hz]. (→ 161)

[TCG]



Sets the way the time code will move.

Select the menu.

: [RECORD SETUP] → [TCG] → desired setting

[FREE RUN]*1:	It will constantly move.
[REC RUN]:	It will move only when recording.

- *1 If the frame rate in [REC FORMAT] or is set to 23.98p, a slight time error may occur when switching to Playback Mode. (→ 162)
- It is automatically set to [FREE RUN] in following cases:
 - When PRE-REC is enabled (→ 97, 184)
 - When [2 SLOTS FUNC.] is set to [BACKGROUND] (→ 178)
 - It is automatically set to [REC RUN] in following cases:
 - During Super Slow Recording (→ 105)
 - In Variable Frame Rate Mode*2 (→ 102)
 - During the Interval Recording (→ 183)
- *2 [FREE RUN] is also available if the number of frames for the frame rate in [REC FORMAT] and the number of frames for Variable Frame Rate Mode are the same.
Example: When [REC FORMAT] is set to [FHD 1080/29.97p 50M] and the frame rate is set to [30]

- The time code will reset when the built-in lithium battery is exhausted when it is set to [FREE RUN].

[TC PRESET]



You can set the initial time code.

1 Select the menu.

 : [RECORD SETUP] → [TC PRESET]

2 Touch the item to set and change with / .

- The value will be set to 00h00m00s00f if you press the RESET/TC SET button.
- “h” is an abbreviation for hour, “m” for minute, “s” for second and “f” for frame.

3 Touch [EXIT] to complete the setting.

-
- This unit will adjust the time code in accordance with the frame rate of the [REC FORMAT] (→ 162). Therefore, it may not be continuous from the previous final time code when the recording format is changed.
 - If the frame rate in [REC FORMAT] is set to 23.98p, set the number of frames to [00] or a multiple of 4. If you enter a different value, time code will not be recorded correctly.

Setting the User Information

Eight digit hexadecimal alphanumeric can be entered and displayed as a memo information such as dates, control numbers, etc., into the User Information.

UB 00 00 00 00

- This is displayed only when [REC MODE] is set to [AVCHD]. (→ 161)

[UB PRESET]



You can set the User Information.

- Set [REC MODE] to [AVCHD]. (→ 161)

1 Select the menu.

 : [RECORD SETUP] → [UB PRESET]

2 Touch the item to set and change with / .

- You can use numbers from 0 to 9 and letters from A to F.
- The value will be set to 00 00 00 00 if you press the RESET/TC SET button.

3 Touch [EXIT] to complete the setting.

Setting the Recording Counter

Recording Counter will display the recording time in seconds.

0:00:00 (hour : minute : second (When [REC COUNTER] is set to [TOTAL]))

SCN 0:00:00 (hour : minute : second (When [REC COUNTER] is set to [SCENE]))

[REC COUNTER]



Select the counting method during the recording.

Select the menu.

MENU



[DISP SETUP] → [REC COUNTER] → desired setting

[TOTAL]:

The count continues to increase until the Recording Counter is reset.

[SCENE]:

Resets the Recording Counter at start of recording. Counts the time of each recording session.

To reset the Recording Counter for the Recording Mode

The Recording Counter will be set to 0:00:00 when the RESET/TC SET button is pressed while displaying the counter.

Synchronizing the time code with an external device



You can synchronize the default time code during multi-camera recording.

- In the following section, the device with the reference time code is referred to as “master”, while the device to be synchronized is referred to as “slave”.

1 Connect the TC PRESET IN/OUT terminals of the two devices with a BNC cable (commercially-available), and turn them on.

- Apply the same [REC FORMAT] and [DF MODE] settings to the two devices. (→ 80, 162)

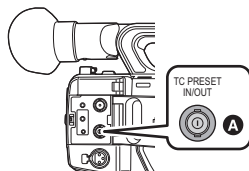

A TC PRESET IN/OUT terminal

2 (On the master device)

Select the [TCG] menu.

MENU : [RECORD SETUP] → [TCG] → [FREE RUN]

3 (On the master device)

Select the [EXT TC LINK] menu.

MENU : [RECORD SETUP] → [EXT TC LINK] → [MASTER]

- The time code will be output from the TC PRESET IN/OUT terminal.
- To cancel the output of the time code, touch [EXIT].

4 (On the slave device)

Select the [EXT TC LINK] menu.

MENU : [RECORD SETUP] → [EXT TC LINK] → [SLAVE]

- [TCG] will be set to [FREE RUN].

5 (On the slave device)

Press the RESET/TC SET button.

- “TC LINK OK” will be displayed and the time code will be synchronized with that of the master device.
- When the time code is not synchronized correctly, “TC LINK NG” is displayed.
- To cancel the operation without synchronizing the time code, touch [EXIT].

-
- Use a commercially-available, double-shielded BNC cable equivalent to 5C-FB.
 - [EXT TC LINK] cannot be set to [SLAVE] in the following cases:
 - During Super Slow Recording (→ 105)
 - In Variable Frame Rate Mode (→ 102)
 - During the Interval Recording (→ 183)

USER button

Each of the USER button can register one function from the 44 available functions.

- There are 9 USER buttons (USER1 to 9) on the main body and 4 USER button icons (USER10 to USER13) displayed on the LCD monitor.



Setting the USER button

1 Select the menu.

 : [USER SW] → [USER1] to [USER13]

- It is not possible to register functions to [USER10] to [USER13] in Playback Mode.

2 Touch the item to register.

- For the functions of the USER button that can be registered, refer to page 86.
- Touch [INHIBIT] if not registering.
- Next (Previous) page can be displayed by touching  / .

3 Touch [EXIT] to complete the setting.

- The tables below show the default settings.

USER1 button	[AREA]
USER2 button	[FOCUS MACRO]
USER3 button	[SLOT SEL]
USER4 button	[WFM]
USER5 button	[ZEBRA]
USER6 button	[O.I.S.]
USER7 button	[LCD/EVF OUTPUT]

USER8 button	[REC CHECK]
USER9 button	[AWB]
USER10 button	[IR REC]
USER11 button	[BACKLIGHT]
USER12 button	[ATW LOCK]
USER13 button	[MENU]

- Performing [ALL] in [INITIAL SET] restores these default settings. (→ 199)

Using the USER button

To use the function assigned to a USER button or USER button icon, press the applicable USER button (one of the USER buttons 1 to 9), or touch the applicable USER button icon (one of the USER button icons 10 to 13) while operation icons are displayed.

(When you use the USER1 to USER7 button)

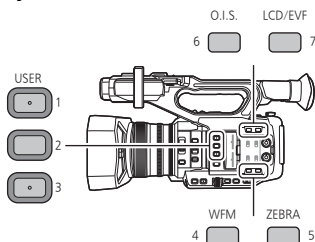

(When you use the USER8 button)

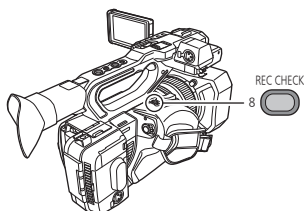

(When you use the USER9 button)

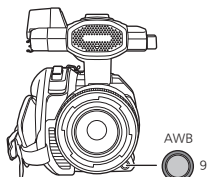

(When you use the USER10 to USER13 button)

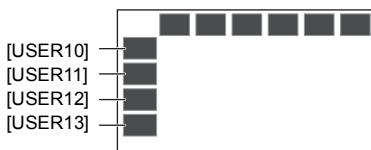

- To cancel, press the USER button or touch the USER button icon again.

For canceling or using of the following functions for the USER buttons, refer to each page.

- [BLACK FADE] (→ 88)
- [WHITE FADE] (→ 88)
- [REC CHECK] (→ 90)
- [LAST SCN DEL] (→ 90)
- [AREA] (→ 92)
- [FOCUS TRANS] (→ 62)
- [BACKGROUND] (→ 95)
- [WFM] (→ 97)
- [ZEBRA] (→ 99)
- [SCENE FILE] (→ 100)
- [AUTO REC] (→ 100)
- [AF AREA] (→ 101)
- [D.ZOOM] (→ 89)
- [LCD/EVF OUTPUT] (→ 33)
- [PUSH AUTO] (→ 56, 57)
- [AWB] (→ 64, 67)

■ Switch display/not-display of the USER buttons

Display/not-display of the USER button icons in the LCD monitor can be switched.

Select the menu.

MENU : [USER SW] → [USER BUTTON DISPLAY] → [ON] or [OFF]

■ Check the setting of the USER buttons

To check the USER button (USER1 to 9) settings on the recording screen, press and hold the DISP/MODE CHK button to display the mode information screen. (→ 110)

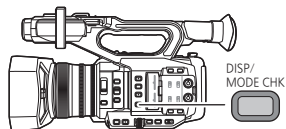

Functions of the USER button

■ List of USER button functions

Item	Icon	Function
[INHIBIT]	[INH]	Invalid
[FOCUS ASSIST 1]	[FA1]	Focus Assist 1
[BACKLIGHT]	[B.Light]	Backlight Compensation
[SPOTLIGHT]	[S.Light]	Spotlight
[BLACK FADE]	[B.FD]	Black Fade
[WHITE FADE]	[W.FD]	White Fade
[ATW]	[ATW]	Auto Tracking White Balance
[ATW LOCK]	[ATW.L]	ATW Lock
[D.ZOOM]	[D.ZM]	Digital Zoom
[FOCUS ASSIST 2]	[FA2]	Focus Assist 2
[REC CHECK]	[REC.C]	Recording Check
[LAST SCN DEL]	[LstDel]	Last Scene Delete
[DRS]	[DRS]	DRS
[FRZ FRAME]	[FRZ]	Freeze Frame
[SUPER GAIN]	[S.Gain]	Super Gain ^{*1}
[AREA]	[AREA]	Area Mode
[FOCUS TRANS]	[F.Tran]	Focus Transition ^{*2}
[PUSH AUTO]	[PushAuto]	Push Auto
[EVF/LCD DETAIL]	[DETAIL]	EVF/LCD detail
[IR REC]	[IR REC]	Infrared Recording
[LEVEL GAUGE]	[Level]	Level Gauge
[BACKGROUND]	[Backgr]	Background
[FLASH BAND]	[FBC]	Flash band compensation
[PRE-REC]	[PRE-REC]	PRE-REC
[WFM]	[WFM]	WFM
[FAST ZOOM]	[F.ZOOM]	Fast Zoom
[EVF ON/OFF]	[EVF SW]	EVF ON/OFF
[A.IRIS LEVEL]	[A.IRIS]	Auto Iris Level
[ZEBRA]	[ZEBRA]	Zebra
[O.I.S.]	[O.I.S.]	Optical Image Stabilizer
[SCENE FILE]	[SCN FILE]	Scene File
[AUTO REC]	[AutoRec]	Auto Rec

*1 Not available in Auto Mode

*2 Not available for Auto Focus

Item	Icon	Function
[AF AREA]	[AF Area]	AF Area Width adjustment
[VFR]	[VFR]	Variable Frame Rate Mode
[FOCUS MACRO]	[F.Macro]	Focus Macro
[i.ZOOM]	[i.Zoom]	i.Zoom
[USB MODE]	[USB]	USB Mode*3
[AWB]	[AWB]	Auto White Balance
[SUPER SLOW]	[SuperSlow]	Super Slow Recording
[SLOT SEL]	[SlotSel]	Slot Selection
[LCD/EVF OUTPUT]	[LCD/EVF]	LCD/EVF Output
[LOW GAIN]	[LowGain]	Low gain
[MID GAIN]	[MidGain]	Mid gain
[HIGH GAIN]	[HighGain]	High gain
[MENU]	[MENU]	Menu

*3 Not available during AG ROP application connection.

- The USER button function can also be set from the following menu item.
 - [DRS] (→ 159)
 - [EVF/LCD DETAIL] (→ 54)
 - [INFRARED REC] (→ 184)
 - [LEVEL GAUGE] (→ 194)
 - [FLASH BAND COMPENSATION] (→ 167)
 - [PRE-REC] (→ 184)
 - [WFM] (→ 174)
 - [FAST ZOOM] (→ 50)
 - [AUTO IRIS LEVEL] (→ 69)
 - [ZEBRA] (→ 174)
 - [O.I.S.] (→ 170)
 - SCENE FILE: [LOAD/SAVE] (→ 153)
 - [i.Zoom] (→ 50)
 - [USB MODE] (→ 198)
 - [AF AREA WIDTH] (→ 56)
 - [VFR MODE] (→ 184)
 - [FOCUS MACRO] (→ 173)
 - [SUPER SLOW REC] (→ 184)
 - [LCD/EVF OUTPUT] (→ 33)

[FOCUS ASSIST 1]



- Register [FOCUS ASSIST 1] to a USER button. (→ 84)

You can set the Focus Assist. (→ 57)

- You can set the Focus Assist method in [FOCUS ASSIST 1] in the [SW SETUP] menu.

[BACKLIGHT]



- Register [BACKLIGHT] to a USER button. (→ 84)

Switches to automatic iris control to compensate the backlight.

This makes the image brighter to prevent darkening of a backlit subject.

-  appears when it is set.
- Canceling [BACKLIGHT] resets the iris mode to the previous setting.

- This item cannot be set during Freeze Frame. (→ 91)

[SPOTLIGHT]



- **Register [SPOTLIGHT] to a USER button.** (→ 84)

Switches to automatic iris control for spotlight.

Very bright object is recorded clearly.

-  appears when it is set.
- Canceling [SPOTLIGHT] resets the iris mode to the previous setting.

-
- This item cannot be set during Freeze Frame. (→ 91)

[BLACK FADE]



- **Register [BLACK FADE] to a USER button.** (→ 84)

Fade in/fade out effect (black) can be added to the video and audio that is being recorded.

Press USER button or touch USER button icon in the recording screen.

- Fade out will start, and fade in will start after completing the fade out.
- It will fade out when the button is pressed and held, and fade in will start when the button is released.

-
- Recording will not start even if the fade out is started. It is possible to press the recording start/stop button during the fade in or fade out.
 - Black Fade is not possible in following cases:
 - During Super Slow Recording (→ 105)
 - In Variable Frame Rate Mode (→ 102)
 - During the Interval Recording (→ 183)
 - During Freeze Frame (→ 91)
 - The thumbnails of scenes recorded using fade in become black.

[WHITE FADE]



- **Register [WHITE FADE] to a USER button.** (→ 84)

Fade in/fade out effect (white) can be added to the video and audio that is being recorded.

Press USER button or touch USER button icon in the recording screen.

- Fade out will start, and fade in will start after completing the fade out.
- It will fade out when the button is pressed and held, and fade in will start when the button is released.

-
- Recording will not start even if the fade out is started. It is possible to press the recording start/stop button during the fade in or fade out.
 - White Fade is not possible in following cases:
 - During Super Slow Recording (→ 105)
 - In Variable Frame Rate Mode (→ 102)
 - During the Interval Recording (→ 183)
 - During Freeze Frame (→ 91)
 - The thumbnails of scenes recorded using fade in become white.

[ATW]



- Register [ATW] to a USER button. (→ 84)

The White Balance can be changed to [ATW]. (→ 65)

- This function is not available when the White Balance mode is set to [ATW LOCK].

[ATW LOCK]



- Register [ATW LOCK] to a USER button. (→ 84)

This sets the White Balance mode to [ATW LOCK].(→ 66)

[D.ZOOM]



- Register [D.ZOOM] to a USER button. (→ 84)

Press USER button or touch USER button icon in the recording screen.

- When [DIGITAL ZOOM] is set to [×2], [×5] or [×10], Digital Zoom will be turned on/off each time you press the button.
- When [DIGITAL ZOOM] is set to [TOGGLE], the zoom magnification will change each time you press the button.
2× → 5× → 10× → Setting canceled

■ To change the zoom magnification of Digital Zoom

The zoom magnification of Digital Zoom varies depending on the [DIGITAL ZOOM] setting.

MENU



[SW SETUP] → [DIGITAL ZOOM] → desired setting

[×2]:	Sets the zoom magnification to 2×.
[×5]:	Sets the zoom magnification to 5×.
[×10]:	Sets the zoom magnification to 10×.
[TOGGLE]:	Changes the zoom magnification each time you press the applicable USER button.

- When using Digital Zoom, the larger you set the zoom magnification, the lower the picture quality becomes.
- Digital Zoom is not possible in following cases:
 - During Freeze Frame (→ 91)
 - When using Area Mode (→ 92)
 - During Super Slow Recording (→ 105)
 - In Variable Frame Rate Mode (→ 102)
 - During the Interval Recording (→ 183)
- Digital zoom is canceled in following cases:
 - If you turn the unit off
 - If you press the THUMBNAIL button
 - When [USB MODE SELECT] is set to [DEVICE] and this unit is connected to a PC. (→ 135)

[FOCUS ASSIST 2]



- **Register [FOCUS ASSIST 2] to a USER button. (→ 84)**

You can set the Focus Assist. (→ 57)

- You can set the Focus Assist method in [FOCUS ASSIST 2] in the [SW SETUP] menu.

-
- When [FOCUS ASSIST 1] in the [SW SETUP] menu is set to [BOTH], the USER button is disabled.

[REC CHECK]



- **Register [REC CHECK] to a USER button. (→ 84)**

Approximately 2 seconds at the end of the video recorded last can be played back. It will return to recording screen once the playback is completed.

-
- Playback operation is not possible during the Recording Check.
 - Recording Check is not possible in following cases:
 - When the unit is turned on/off
 - When the THUMBNAIL button is pressed
 - When the SD card is inserted/removed
 - When the setting of [REC FORMAT] is changed (→ 162)
 - Set [2 SLOTS FUNC.] to [SIMULTANEOUS] or [BACKGROUND]. (→ 178)
 - PRE-REC is used (→ 97, 184)
 - During the Interval Recording (→ 183)
 - During Freeze Frame (→ 91)

[LAST SCN DEL]



- **Register [LAST SCN DEL] to a USER button. (→ 84)**

The motion picture recorded last can be deleted.

Deleted scenes cannot be restored.

- 1 Press USER button or touch USER button icon in the recording screen.**
- 2 Touch [YES].**

- It will return to recording screen without deleting by touching [NO].

-
- Last Scene Delete is not possible in following cases:
 - When the unit is turned on/off
 - When the THUMBNAIL button is pressed
 - When the SD card is inserted/removed
 - When the setting of [REC FORMAT] is changed (→ 162)
 - Set [2 SLOTS FUNC.] to [SIMULTANEOUS], [BACKGROUND] or [DUAL CODEC]. (→ 178)
 - During the Interval Recording (→ 183)

[DRS]



- **Register [DRS] to a USER button.** (→ 84)

Selects the DRS (Dynamic Range Stretcher) function.

It is possible to expand the dynamic range by compressing the video signal level of the highly illuminated area that gets washed out with standard recording.

-
- This item is not available in the following cases:
 - During Super Slow Recording (→ 105)
 - In Variable Frame Rate Mode (→ 102)
 - If there are extremely dark or bright parts or the brightness is insufficient, the effect may not be clear.
 - It is also possible to adjust the compression level of the highly illuminated area by changing the [DRS EFFECT] setting. (→ 160)

[FRZ FRAME]



- **Register [FRZ FRAME] to a USER button.** (→ 84)

Freezes the image on the unit.

- will appear on the screen and flash.

-
- If you record a motion picture during Freeze Frame, the frozen image and sounds will be recorded.
 - You can perform the following camera operations during Freeze Frame. Other camera operations will be disabled.
 - Recording motion pictures
 - Canceling Freeze Frame
 - Operating the FOCUS A/M/ ∞ switch
 - This function is not available in the following cases:
 - When using Focus Assist (→ 57)
 - During Super Slow Recording (→ 105)
 - In Variable Frame Rate Mode (→ 102)
 - During the Interval Recording (→ 183)
 - When color bars are displayed (→ 108)
 - Freeze Frame is canceled if you operate this unit in any of the following ways:
 - Turning off the unit
 - Pressing the THUMBNAIL button
 - Enabling Super Slow Recording.
 - Setting this unit to Variable Frame Rate Mode
 - Setting [USB MODE SELECT] to [DEVICE] and connecting this unit to a PC (→ 135)

[SUPER GAIN]



- **Register [SUPER GAIN] to a USER button.** (→ 84)

- **Switch to Manual Mode.** (→ 45)

This changes the gain value to a [SUPER GAIN] value. (→ 71)



You can apply a variety of effects to the subject you touch.

■ Setting an Area Mode effect

You can select the following menu items to set an effect to be applied when you touch the subject.

MENU



[SW SETUP] → [AREA MODE] → desired setting

[INH]:	Does not apply any effects of Area Mode.
[FOCUS]:	Optimizes the focus automatically for the subject you touch.
[IRIS]:	Optimizes the iris automatically for the subject you touch.
[Y GET]:	Displays the luminance level of the subject you touch.
[FOCUS/IRIS]:	Optimizes the focus and iris automatically for the subject you touch.
[FOCUS/Y GET]:	Optimizes the focus automatically for the subject you touch and displays the luminance level of the subject.

■ Using Area Mode

- Register [AREA] to a USER button. (→ 84)

1 Press the applicable USER button or touch the applicable USER button icon on the recording screen.

- Area Mode will be enabled and [AREA] will be displayed.

2 Touch the recording screen.

- The area frame will be displayed on the part you have touched. The effect of the selected menu item will be applied.

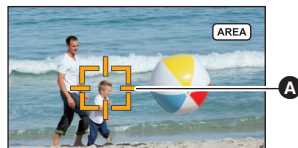

A Area frame

To turn off Area Mode

(With a USER button)

Press the USER button

(With a USER button icon)

1 Touch and hold the recording screen to display operation icons.

2 Touch the USER button icon.

To change the size of the area frame

You can rotate the jog dial to change the size of the area frame.

- The area frame is available in three sizes.

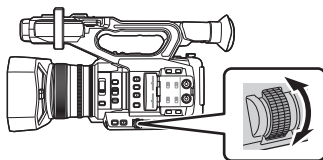

- Area mode is not possible in following cases:
 - During Super Slow Recording (→ 105)
 - In Variable Frame Rate Mode (→ 102)
 - During AG ROP application connection (→ 143)
- Area mode is canceled in following cases:
 - If you turn the unit off
 - If you press the THUMBNAIL button
 - If you switch to a [REC FORMAT] setting with a frame rate of 24.00p. (→ 162)
 - When the setting of [ASPECT CONVERT] is changed (→ 166)
 - When [USB MODE SELECT] is set to [DEVICE] and this unit is connected to a PC (→ 135)
- When using Area Mode, even if you set [ZEBRA] to [MARKER], the luminance display frame will not be displayed. (→ 99, 174)
In addition, the luminance level will not be displayed if [AREA MODE] is set to [FOCUS], [IRIS] or [FOCUS/IRIS].

[FOCUS TRANS]



- Register [FOCUS TRANS] to a USER button. (→ 84)
- Switch to Manual Focus Mode. (→ 53)

With Focus Transition, you can move the current focus position to a pre-registered focus position. (→ 61)

[PUSH AUTO]



- Register [PUSH AUTO] to a USER button. (→ 84)
You can use the USER button as the PUSH AUTO button.
- Pressing the USER button or touching the USER button icon in Manual Focus Mode allows you to use One Push AF. (→ 56)
- Pressing and holding the USER button or touching and holding the USER button icon in Manual Focus Mode allows you to use Push AF. (→ 57)

[EVF/LCD DETAIL]



- Register [EVF/LCD DETAIL] to a USER button. (→ 84)
[EVF/LCD DETAIL] helps you achieve focus easier by emphasizing the outlines of an image displayed on the LCD monitor or the viewfinder. (→ 54)
- These settings will not affect the images actually recorded.



- **Register [IR REC] to a USER button. (→ 84)**

This changes the Infrared Recording Mode setting.

- This unit operates as follows in Infrared Recording Mode:
 -  appears on the screen.
 - The iris, gain, and shutter speed are adjusted automatically.
 - When [AUTO SLOW SHTR] is set to [ON], the shutter speed will be automatically adjusted to 1/30, 1/24 or 1/25. (→ 177)

- It is recommended to use a tripod.
- It takes longer to focus with Auto Focus in dark locations.
- Do not use this function in a bright location. Doing so may cause malfunction.
- You can record a clear image by positioning the center area of the screen over the subject.
- This function is not available in the following cases:
 - During Super Slow Recording (→ 105)
 - In Variable Frame Rate Mode (→ 102)
- Focus values may not be displayed correctly in Infrared Recording Mode. (→ 53)
- The following menu items are not available in Infrared Recording Mode:
 - [FILE SELECT] (→ 152)
 - [NAME EDIT] (→ 153)
 - [LOAD/SAVE]
(USER button function: [SCENE FILE])
(→ 100, 153)
 - [MASTER DETAIL] (→ 154)
 - [DETAIL CORING] (→ 154)
 - [SKIN TONE DTL] (→ 154)
 - [V DETAIL LEVEL] (→ 154)
 - [RB GAIN CONTROL SETTING] (→ 155)
 - [CHROMA LEVEL] (→ 156)
 - [CHROMA PHASE] (→ 156)
 - [MATRIX] (→ 156)
 - [COLOR CORRECTION SETTING]
(→ 157)
 - [MASTER PED] (→ 158)
 - [GAMMA MODE] (→ 158)
 - [BLACK GAMMA] (→ 158)
 - [KNEE MODE] (→ 159)
 - [KNEE MASTER POINT] (→ 159)
 - [KNEE MASTER SLOPE] (→ 159)
 - [DRS] (→ 91, 159)
 - [DRS EFFECT] (→ 160)
 - [AUTO IRIS LEVEL] (→ 69, 99)
 - [AUTO IRIS LEVEL EFFECT] (→ 69)
 - [HIGH SENS. MODE] (→ 167)
 - [ATW TARGET R] (→ 66)
 - [ATW TARGET B] (→ 66)
 - [WB VAR] (→ 172)
 - [MF ASSIST] (→ 60)
 - [CUSTOM AF] (→ 55)
 - [AF SPEED] (→ 55)
 - [AF SENSITIVITY] (→ 55)
 - [FOCUS TRANSITION] (→ 61)
- The following functions are not available in Infrared Recording Mode:
 - Focus Transition (→ 62)
 - Change the White Balance mode (→ 64)
 - Iris adjustment (→ 68)
 - Gain adjustment (→ 70)
 - AGC Limit (→ 71)
 - Shutter speed adjustment (→ 72)
 - ND filter (→ 109)
 - Backlight Compensation (→ 87)
 - Spotlight (→ 88)
 - ATW (→ 89)
 - ATW Lock (→ 66)
 - Super Gain (→ 71)
- It is also possible to change the color in which images are recorded in [IR REC COLOR] (→ 185)

[LEVEL GAUGE]



- Register [LEVEL GAUGE] to a USER button. (→ 84)

This function displays the horizontal/vertical tilt of the unit with the electronic level.

■ To correct the tilt

(Horizontal direction)

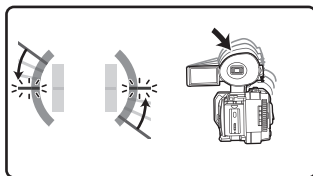

When correcting the leftward tilt

(Vertical direction)

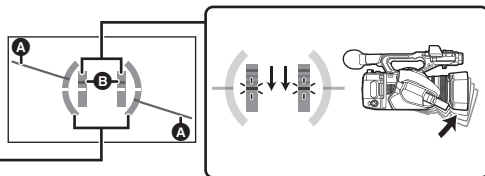

When correcting the downward tilt

- The horizontal tilt display **A** and vertical tilt display **B** appear yellow when there is a tilt, and appear green when there is almost no tilt.
- The maximum tilt display angles are approximately 45 ° in horizontal direction and 10 ° in vertical direction.
- The electronic level does not affect the actual recorded images.

-
- This function is not available in the following cases:

- During Freeze Frame (→ 91)
- When color bars are displayed (→ 108)

- If [SELF SHOOT] (→ 196) is set to [MIRROR], the electronic level will not be displayed when you record yourself.

- Even when the tilt is in the corrected state, an error of approximately 1 ° may occur.

- In the following cases, the electronic level may not be displayed correctly:

- When moving this unit
- When pointing this unit up or down at an angle closer to perpendicular

[BACKGROUND]



- Register [BACKGROUND] to a USER button. (→ 84)

When [2 SLOTS FUNC.] is set to [BACKGROUND], you can start/stop background recording.

- When the recording destination of motion pictures is set to [SD CARD 1] in [MEDIA SELECT] (→ 42), [SD CARD 2] will be used for background recording.

The following instructions assume that the recording destination of motion pictures is set to [SD CARD 1].

- Set [2 SLOTS FUNC.] to [BACKGROUND]. (→ 178)

BACKGR is displayed beside the SD card display for card 2.

(To start background recording)

Press the applicable USER button or the applicable USER button icon.

- Background recording will start on the SD card in card slot 2. (**BACKGR** will be displayed in red.)

(To stop background recording)

While motion picture recording to [SD CARD 1] is stopped, press and hold the applicable USER button or the USER button icon.

-
- Please refer to page 180 about Background recording.



- Register [FLASH BAND] to a USER button. (→ 84)

If you set this item to [ON], you can compensate for and reduce flash band, a phenomenon that creates markedly different levels of luminance between the top and bottom of the image when recording is performed in an environment where another camera is firing its flash.

- FBC appears on the screen.

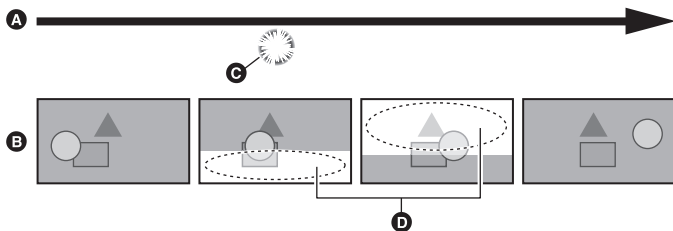

- A Time flow
- B Image recorded
- C Flash firing
- D Flash band

■ Note on the use of the Flash Band Compensation function

Regardless of whether a flash is fired or not, the Flash Band Compensation function is activated whenever an external light source drastically changes the brightness of the lower half of the screen. The function, as a result, may be activated in recording situations such as when you zoom in or out on a bright window. We recommend using the function in recording situations where flashes are expected to be fired.

Please note that the Flash Band Compensation function may not produce an adequate effect in certain recording situations even when a flash is fired.

- The phenomena below may occur when a flash is fired. These are caused by the Flash Band Compensation function and are not malfunctions.
 - Moving subjects appear as if they have stopped for an instant
 - The resolution deteriorates when a flash is fired.
 - Horizontal lines appear in the image when a flash is fired.
- This function is not available in the following cases:
 - When the frame rate in [REC FORMAT] is 29.97p, 23.98p, 24.00p or 25.00p (→ 162)
 - When using [DIGITAL ZOOM] (→ 89)
 - During Freeze Frame (→ 91)
 - During Super Slow Recording (→ 105)
 - In Variable Frame Rate Mode (→ 102)
- The setting will be turned off in the following cases:
 - If you turn the unit off
 - If you press the THUMBNAIL button
 - When [USB MODE SELECT] is set to [DEVICE] and this unit is connected to a PC. (→ 135)
- The shutter speed will be set to 1/60 or 1/50. It is not possible to adjust the shutter speed.

[PRE-REC]



- **Register [PRE-REC] to a USER button.** (→ 84)

This allows the recording of an image and audio to start before you press the recording start/stop button. AVCHD scenes will be recorded from approximately 3 seconds before the operation, while MOV/MP4 will be recorded from approximately 4 seconds before the operation.

- [P-] is displayed on the screen. After you start recording, the display changes to [P-REC].

- **Aim the unit at the subject beforehand.**

- There is no beep sound.
- This function is not available in the following cases:
 - During Super Slow Recording (→ 105)
 - In Variable Frame Rate Mode (→ 102)
 - When [2 SLOTS FUNC.] is set to [BACKGROUND] (→ 178)
 - During the Interval Recording (→ 183)
- In the following cases, a 3 second image that precedes the recording of an AVCHD scene or a 4 second scene that precedes the recording of an MOV/MP4 scene may not be recorded:
 - Immediately after the maximum PRE-REC standby time has elapsed*
 - If the length of time from when [PRE-REC] is set to [ON] to when you start recording is too short
 - If the length of time from when you display the recording screen by turning it off and on or pressing the THUMBNAIL button to when you start recording is too short since you set PRE-REC
 - When the card slot selected for motion picture recording is switched automatically because you started recording with normal settings or when [2 SLOTS FUNC.] is set to [RELAY REC] (→ 42)
- * The maximum PRE-REC standby time is 3 hours. Once PRE-REC is activated, it is automatically deactivated and then re-activated every 3 hours.
- Images displayed on the thumbnail in Playback Mode will differ from the motion pictures displayed at the start of playback.

[WFM]



- **Register [WFM] to a USER button.** (→ 84)

This function displays waveforms on the LCD monitor.

Press USER button in the recording screen.

- When [WFM TYPE] is set to [WAVE] or [VECTOR], each press of the button enables/disables WFM.
- When [WFM TYPE] is set to [WAVE/VECTOR], each press of the button switches the setting. WAVE (wave display) → VECTOR (vector display) → OFF

-
- If you have enabled WFM by touching the applicable USER button icon, set [WFM] to [OFF] to disable it. (→ 174)
 - This function is not available in the following cases:
 - When using the viewfinder
 - When recording yourself (→ 38)
 - When using Focus Assist (→ 57)
 - During Freeze Frame (→ 91)
 - When color bars are displayed. (→ 108)
 - [WFM] will be canceled in the following cases:
 - If you turn the unit off
 - If you press the THUMBNAIL button
 - When [USB MODE SELECT] is set to [DEVICE] and this unit is connected to a PC. (→ 135)

■ To change the type of WFM

Select the menu.

 : [SW SETUP] → [WFM TYPE] → desired setting

[WAVE]:	Displays waveforms as waves.
[VECTOR]:	Displays waveforms as vectors.
[WAVE/VECTOR]:	Switches the setting each time the applicable USER button is pressed.

- This function is not available in the following cases:

- When using Focus Assist (→ 57)
- During Freeze Frame (→ 91)
- When color bars are displayed (→ 108)

■ To change the display position of WFM

Select the menu.

 : [SW SETUP] → [WFM POSITION] → desired setting

[TOP/LEFT]/[TOP/RIGHT]/[BOTTOM/LEFT]/[BOTTOM/RIGHT]

- You can also change the waveform position to the upper left, upper right, bottom left or bottom right by performing one of the following operations while a waveform is displayed:
 - Rotating the jog dial
 - Sliding the waveform while touching it.

[FAST ZOOM]



- Register [FAST ZOOM] to a USER button. (→ 84)

You can use Fast Zoom when operating the zoom with the zoom lever. (→ 50)

[EVF ON/OFF]



- Register [EVF ON/OFF] to a USER button. (→ 84)

This forces the viewfinder to turn on/off.

- After the viewfinder turns on, if the eye sensor detects your eye when it is moved closer to the eye cup of the viewfinder the [EVF ON/OFF] setting will be canceled.

- When the [LCD/EVF OUTPUT] is set to [LCD], this item cannot be set. (→ 33)

[A.IRIS LEVEL]



- Register [A.IRIS LEVEL] to a USER button. (→ 84)

This enables/disables the Auto Iris Level.

- When this item is enabled, the [AUTO IRIS LEVEL EFFECT] setting is applied. (→ 69)

[ZEBRA]



- Register [ZEBRA] to a USER button. (→ 84)

Press USER button or touch USER button icon in the recording screen.

It will switch between the zebra display and the marker display every time the button is pressed.

Zebra 1 → Zebra 2* → Marker* → setting canceled

* It is not displayed when the [ZEBRA DETECT 2]/[MARKER] is set to [OFF]. (→ 192)

(When Zebra 1 is set)

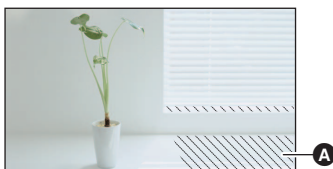

(When Marker is set)

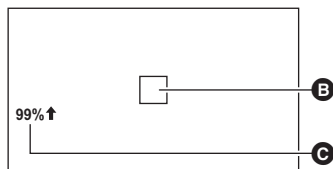

Zebra display:

Parts where white saturation (color saturation) is likely to occur (extremely brightly lit or shiny parts) are displayed with diagonal lines (zebra pattern **A**).

Marker display:

Displays the luminance level of the center of the screen (luminance display frame **B**) in %.

It makes the adjustment of the brightness of the object easier, by checking the luminance level of the object, when recording same object in different surroundings.

- Luminance level **C** is displayed between 0% and 99%. It will be displayed as 99% ↑ when it is over 99%.

-
- This function is not available in the following cases:

- When [WFM] is set to [ON] (→ 97, 174)
- During Freeze Frame (→ 91)

- You can record an image with little white saturation if you manually adjust the shutter speed or brightness not to display zebra pattern. (→ 68, 72)
- The zebra pattern does not appear on the images actually recorded.
- It is also possible to adjust the level of the zebra pattern to be displayed. (→ 192)
- It is also possible to change the [ZEBRA MODE] setting to change the display time for the zebra pattern display. (→ 174)

[O.I.S.]



- Register [O.I.S.] to a USER button. (→ 84)

This enables/disables the Image Stabilizer. (→ 51)

[SCENE FILE]



- Register [SCENE FILE] to a USER button. (→ 84)

You can save the scene file settings to the SD card or load them from the SD card to this unit.

■ Saving scene file settings

- 1 Press USER button or touch USER button icon in the recording screen.
- 2 Touch [SAVE].
- 3 Touch the name of the scene file.
 - All scene number settings ([F1:] to [F6:]) will be saved.
 - Up to 8 files can be saved.
 - If you have touched the name of the existing scene file, touch [YES] to overwrite it.
- 4 Touch [EXIT] to complete the setting.

■ Assigning saved scene files to scene numbers

- 1 Press USER button or touch USER button icon in the recording screen.
- 2 Touch [LOAD].
- 3 Touch the name of the scene file you want to load.
- 4 Touch / to select the scene number to which you want to assign the scene file.
- 5 Touch [RETURN].
 - When you touch [YES], Settings* of the scene number you have selected will be loaded and then assigned to the corresponding scene number in [FILE SELECT].
 - * The title of the scene number will also be loaded.
 - If you select [ALL], settings of all scene numbers will be loaded.
- 6 Touch [EXIT] to complete the setting.

-
- You can also access this function by selecting menu items.
[SCENE FILE] → [LOAD/SAVE] → [LOAD] or [SAVE]

[AUTO REC]



- Register [AUTO REC] to a USER button. (→ 84)

This enables/disables a function that controls recording performed with an external device (recorder, etc.) connected to this unit.

- 1 Select the appropriate option in the [OUTPUT SEL] menu.

: [OUTPUT SETUP] → [OUTPUT SEL] → [HDMI] or [SDI]

- Select the option that corresponds to the terminal to which the external device is connected.

- 2 Select the [REMOTE REC] menu.

: [OUTPUT SETUP] → [REMOTE REC] → [ON]

3 Select the [REMOTE REC LINK] menu.

MENU  : [OUTPUT SETUP] → [REMOTE REC LINK] → [OFF]

4 (When the external device is connected to the HDMI OUT terminal)

Select the [HDMI TC OUTPUT] menu.

MENU  : [OUTPUT SETUP] → [HDMI TC OUTPUT] → [ON]

5 Press USER button or touch USER button icon in the recording screen.

- This will display SDI ● or HDMI ● and send a signal to the external device instructing it to start recording.
- To stop recording to the external device, press the applicable USER button or touch the applicable USER button icon again. This will display SDI ■■ or HDMI ■■ and send a signal to the external device instructing it to stop recording.
- When the external device is connected to the SDI OUT terminal SDI ● / SDI ■■ is displayed.
- When the external device is connected to the HDMI OUT terminal, HDMI ● / HDMI ■■ is displayed.

• It is not possible to control recording performed with an external device connected to the SDI OUT terminal in the following cases:

- When [REC FORMAT] is set to [SA 480/59.94i] or [SA 576/50.00i] (→ 162)
- When [RESOLUTION] is set to [DOWN CONV.] (→ 130)

[AF AREA]



• Register [AF AREA] to a USER button. (→ 84)

You can adjust the area width where Auto Focus works according to the size of the subject. (→ 56)

1 Press USER button or touch USER button icon in the recording screen.

-  are displayed on the screen.

2 Rotate the jog dial to adjust the AF area frame.

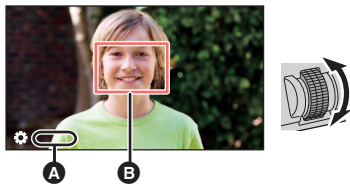

- A [AF AREA]
- B AF area frame

3 Push the jog dial to finish the adjustment.

- Press USER button or touch the USER button icon to cancel the setting.
- To adjust the AF area frame again, press the jog dial while the on-screen icon  AF AREA (yellow) is displayed, and repeat Steps 2–3.
- For information on on-screen icons, refer to 113.





This enables/disables Variable Frame Rate (VFR) Mode.

In Variable Frame Rate Mode, you can record quick or slow motion picture by changing the frame rate before recording.

Slow motion (overcrank recording)

Used in scenes such as climaxes, a slow motion effect creates a dramatic impression. Set a frame rate that provides more frames than the frame rate in [REC FORMAT] does.

Example: If you set [FHD 1080/25.00p 50M] to 50 fps and record a motion picture, a slow motion effect of 1/2 can be gained.

Quick motion (undercrank recording)

A fast motion effect is used in scenes showing the flow of clouds, people standing in the middle of crowds, etc. Set a frame rate that provides less frames than the frame rate in [REC FORMAT] does.

Example: If you set [FHD 1080/25.00p 50M] to 12 fps and record a motion picture, a quick motion effect of 2× (approx.) can be gained.

- Register [VFR] to a USER button. (→ 84)
- Make the [REC MODE] and [REC FORMAT] settings. (→ 161, 162)
- Variable Frame Rate Mode is available for the following [REC MODE] and [REC FORMAT] settings.

System frequency setting	Recording mode	Recording format
59.94Hz	MOV, MP4	FHD 1080/29.97p 50M, FHD 1080/23.98p 50M
50.00Hz		FHD 1080/25.00p 50M

1 Press USER button or touch USER button icon in the recording screen.

- [VFR] will be displayed.
- The frame rate display will change.

(Example)

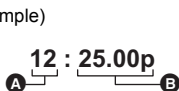

- A** Frame Rate (fps)
- B** Frame rate in [REC FORMAT]

- [REC] / [VREC] will be displayed. Audio is not recorded during recording.

2 Rotate the jog dial to change the frame rate.

- You can set a frame rate between 2 and 60 or between 2 and 50. Depending on the [REC FORMAT] setting, some frame rates are not available.
- Push the jog dial to set the frame rate. If you start recording before pushing the jog dial, the setting will not be applied.

3 Press the recording start/stop button to start recording.

- When recording in Variable Frame Rate Mode for the first time since you turned on this unit, a message is displayed, informing you that audio cannot be recorded.*

* Audio is recorded when the number of frames for the frame rate in [REC FORMAT] and the number of frames for Variable Frame Rate Mode are the same.

- The frame rate cannot be changed during recording.

4 Press the recording start/stop button again to stop recording.

- To cancel Variable Frame Rate Mode, press USER button, or touch USER button icon.

■ Frame rates and their effects

Quick motion (undercrank) or slow motion (overcrank) recording is possible with the following frame rate settings:

[REC FORMAT]	Available frame rates		
[FHD 1080/29.97p 50M]	2 fps to 28 fps	30 fps	32 fps to 60 fps
[FHD 1080/23.98p 50M]	2 fps to 22 fps	24 fps	26 fps to 60 fps
[FHD 1080/25.00p 50M]	2 fps to 23 fps	25 fps	27 fps to 50 fps
Effect on playback	Quick motion (The smaller the value is, the faster the playback becomes.)	Normal	Slow motion (The larger the value is, the slower the playback becomes.)
Audio recording	No	Yes	No

■ Frame rates during actual recording

There is a slight difference between each frame rate that can be selected and the actual frame rate at which recording is performed.

Recording will be performed at one of the frame rates below.

- Top row: frames rates that can be selected (fps); bottom row: frame rates during actual recording (fps)

(When [SYSTEM FREQ] is set to [59.94Hz])

2	12	15	20	22	24	26	28	30	32
2.00	11.99	14.99	19.98	22.48	23.98	25.69	27.97	29.97	31.97
34	36	45	48	60					
33.72	35.96	44.96	47.95	59.94					

(When [SYSTEM FREQ] is set to [50.00Hz])

2	12	21	23	25	27	30	37	50
2.08	12.50	20.83	23.08	25.00	27.50	30.00	37.50	50.00

- You can also enable/disable Variable Frame Rate Mode or change the frame rate using the menu.
 - [VFR MODE] (→ 184)
 - [FRAME RATE] (→ 184)
- Variable Frame Rate Mode is set to [OFF] in following cases:
 - When the [REC MODE] or [REC FORMAT] setting is changed to a setting that does not support Variable Frame Rate Mode
- The following functions are canceled:
 - Flash band compensation (→ 96, 167)
 - Relay recording (→ 178)
 - Background recording (→ 178)
 - Interval Recording (→ 183)
 - PRE-REC (→ 97, 184)
 - Hybrid Optical Image Stabilizer (→ 51)
 - Area Mode (→ 92)
 - Focus Transition (→ 61)
 - Digital Zoom (→ 89)
 - Infrared Recording mode (→ 94, 184)
 - Custom AF function (→ 55)
 - i.Zoom (→ 50)
 - Freeze Frame (→ 91)
 - Super Slow Recording (→ 105)

- It is not possible to adjust the shutter speed to a value slower than the limit imposed by the set frame rate.

Example:

When [REC FORMAT] is set to [FHD 1080/25.00p 50M], if you set the frame rate to 25 fps, the shutter speed cannot be adjusted to a value slower than 1/25.

- [BLACK FADE] and [WHITE FADE] are disabled. (→ 88)
- Even if you press the recording start/stop button as soon as recording has started, it may take some time until the recording stops.
- The screen may momentarily black out when the frame rate is changed in Step 2.
- When using Variable Frame Rate (VFR) Mode with a low frame rate setting, this unit may not be able to keep up with changes in the image. In such a case, set the iris, focus and White Balance mode to manual settings.
- The maximum continuous recordable time for one scene in Variable Frame Rate Mode varies depending on the set frame rate. Recording stops when a certain time has elapsed since the start of the recording, and restarts automatically a few seconds later.
 - With undercrank recording: 10 hours
 - When recording with the same frame rate as the frame rate in [REC FORMAT]: 10 hours
 - With overcrank recording, the recordable time becomes shorter than 10 hours depending on the ratio between the frame rate for [REC FORMAT] and variable frame rate setting.

Example: When [REC FORMAT] is set to [FHD 1080/25.00p 50M]

Variable frame rate setting	Maximum continuous recordable time for one scene
2 fps	10 h
25 fps	
50 fps	5 h

- "h" is an abbreviation for hour.

[FOCUS MACRO]



- Register [FOCUS MACRO] to a USER button. (→ 84)

You can enable/disable Focus Macro.

-  is displayed on the screen when [ON] is selected.

[i.ZOOM]



- Register [i.ZOOM] to a USER button. (→ 84)

You can enable/disable i.Zoom. (→ 50)

[USB MODE]



- Register [USB MODE] to a USER button. (→ 84)

Enable/disable connection to the USB ports of this unit.

-
- If you switch the setting from on to off while a USB port is in use, a message may be displayed, instructing you to unmount the USB cable safely. Select [YES] to terminate the connection safely.



- Register [AWB] to a USER button. (→ 84)

You can change the White Balance mode or use Auto White Balance or Auto Black Balance. (→ 64, 67)

[SUPER SLOW]



This enables/disables Super Slow Recording. You can enable this function to record slow motion pictures.

- Register [SUPER SLOW] to a USER button. (→ 84)
- Make the [REC MODE] and [REC FORMAT] settings. (→ 161, 162)
- Super Slow Recording is available for the following [REC MODE] and [REC FORMAT] settings:

System Frequency setting	Recording mode	Recording format
59.94Hz	MOV, MP4	FHD 1080/29.97p 50M, FHD 1080/23.98p 50M
50.00Hz		FHD 1080/25.00p 50M

1 Press USER button or touch USER button icon in the recording screen.

- [SUPER SLOW] will be displayed.
- The frame rate display will change.

(Example)

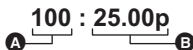

- A** Frame rate (fps): indicated in blue
- B** Frame rate in [REC FORMAT]

-  /  will be displayed. Audio is not recorded during recording.

2 Press the recording start/stop button to start recording.

- When recording in Super Slow Recording for the first time since you turned on this unit, a message is displayed, informing you that audio cannot be recorded.

3 Press the recording start/stop button again to stop recording.

- To cancel Super Slow Recording, press USER button, or touch USER button icon.

■ Frame rates and their effects

The slow motion speed during playback varies depending on the frame rate in [REC FORMAT].

Frame rate of [REC FORMAT]	29.97p, 25.00p	23.98p
Slow motion speed during playback	1/4× the normal speed	1/5× the normal speed

- This function can also be set from the menu.
[RECORD SETUP] → [SUPER SLOW REC] (→ 184)
- Super Slow Recording is disabled if any of the following operations is performed:
 - Setting [REC MODE] or [REC FORMAT] to a setting not available for Super Slow Recording

- The following functions are canceled:
 - Flash band compensation (→ 96, 167)
 - Relay recording (→ 178)
 - Background recording (→ 178)
 - Interval Recording (→ 183)
 - PRE-REC (→ 97, 184)
 - Hybrid Optical Image Stabilizer (→ 51)
 - Area Mode (→ 92)
 - Focus Transition (→ 61)
 - Digital Zoom (→ 89)
 - Infrared Recording mode (→ 94, 184)
 - Custom AF function (→ 55)
 - i.Zoom (→ 50)
 - Freeze Frame (→ 91)
 - Variable Frame Rate Mode (→ 102)

- (When [SYSTEM FREQ] is set to [59.94Hz])

There is a slight gap between the displayed frame rate for Super Slow Recording and the actual frame rate at which Super Slow Recording is performed. Although [120] is displayed on the screen, the actual recording is performed at 119.88 fps.

- It is not possible to adjust the shutter speed to a value slower than the limit imposed by the frame rate used for Super Slow Recording.
(Example) When [SYSTEM FREQ] is set to [59.94Hz], the shutter speed cannot be adjusted to a value smaller than 1/120.
- [BLACK FADE] and [WHITE FADE] are disabled. (→ 88)
- Even if you press the recording start/stop button as soon as recording has started, it may take some time until the recording stops.
- The maximum continuous recordable time for one scene in Super Slow Recording varies depending on the frame rate of [REC FORMAT]. Recording stops when a certain time has elapsed since the start of the recording, and restarts automatically a few seconds later.

Frame rate of [REC FORMAT]	Maximum continuous recordable time for one scene
29.97p, 25.00p	2 h 30 min
23.98p	2 h

- “h” is an abbreviation for hour, “min” for minute and “s” for second.

[SLOT SEL]



- Register [SLOT SEL] to a USER button. (→ 84)

You can change the card slot used for motion picture recording or the playback media.

- You can change the setting in the following situations:
 - While recording is paused in Recording Mode
 - While a thumbnail screen is displayed in Playback Mode (→ 115)
 - While the list by date is selected (→ 121)

[LCD/EVF OUTPUT]



- Register [LCD/EVF OUTPUT] to a USER button. (→ 84)

This changes how to turn on/off the LCD monitor and Viewfinder. (→ 33)

[LOW GAIN]



- Register [LOW GAIN] to a USER button. (→ 84)

The gain value can be changed to low gain. (→ 70)

- This item cannot be set during Freeze Frame. (→ 91)

[MID GAIN]



- Register [MID GAIN] to a USER button. (→ 84)

The gain value can be changed to middle gain. (→ 70)

- This item cannot be set during Freeze Frame. (→ 91)

[HIGH GAIN]



- Register [HIGH GAIN] to a USER button. (→ 84)

The gain value can be changed to high gain. (→ 70)

- This item cannot be set during Freeze Frame. (→ 91)

[MENU]



- Register [MENU] to a USER button. (→ 84)

The menu can be displayed.

Useful functions

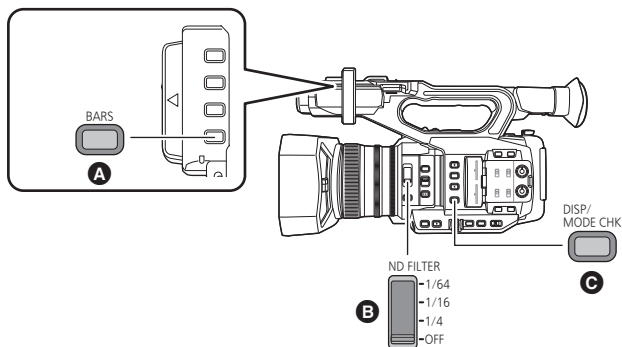

- A** BARS button
- B** ND FILTER switch
- C** DISP/MODE CHK button

Color Bar Screen

BARS button

Press the BARS button to output a color bar screen to an external monitor so you can adjust them.

- To cancel, press the BARS button again.
- It will be canceled when the unit is turned off.
- While color bars are displayed, a test tone will be output from the headphone terminal and a particular external output terminal. It will not be output from the speaker of this unit.
- Different color bars are displayed depending on the [BARS TYPE] setting. (→ 174)
- The frequency of a test tone that is output when color bars are displayed differs depending on the setting of the following items:
 - [SYSTEM FREQ] (→ 161)
 - Frame rate in [REC FORMAT] (→ 162)

System Frequency setting	Frame rates	Test tone frequency
59.94Hz	All frame rates	1 kHz
50.00Hz	24.00p	
	50.00p/50.00i/25.00p	997 Hz

- The test tone volume differs depending on the [TEST TONE] setting. (→ 191)
- You can record color bars as motion pictures.
- If you press the BARS button while recording color bars as a motion picture, you can stop displaying the color bars. To display them again, stop the recording and press the BARS button.

ND filter

Using the ND filter switch, you can switch the built-in optical ND filter setting. (The filter adjusts the amount of light.)

- Use this function when recording a bright subject outdoors under a clear sky that causes the screen to look white.

Slide the ND filter switch.

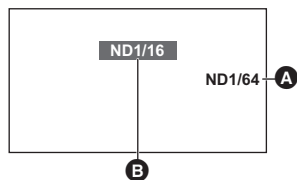

- Ⓐ ND filter setting
- Ⓑ Recommended ND filter setting

1/64:	Reduces the amount of light to 1/64.
1/16:	Reduces the amount of light to 1/16.
1/4:	Reduces the amount of light to 1/4.
OFF:	Does not use the ND filter.

- If the selected setting 1/64, 1/16 or 1/4 does not match an ND filter setting recommended by this unit, the recommended setting will be displayed on the screen, blink for approximately 5 seconds and disappear.

- A recommend ND filter setting may not be displayed correctly in scenes that are too dark.

Switching the screen indications/mode information display

DISP/MODE CHK button

When the DISP/MODE CHK button is pressed, all screen displays disappear, except for the counter display, time stamp display*, zebra pattern display, marker display, and safety zone display. (→ 204)

* When [DATE/TIME] is set to [TIME], [DATE], or [DATE&TIME]

- To cancel the setting, press the DISP/MODE CHK button.

■ To display the Mode Information

Press and hold the DISP/MODE CHK button to display the mode information screen first. Each time you press the button, the display mode of the screen switches in the following order:

Mode information display1 → Mode information display2 → Mode information display3 →
Mode information display4 → Mode information display5 → Normal display

Mode information display1: Displays the list of functions assigned to the USER buttons (USER1 to 9).

Mode information display2: Displays the title given to each scene number of a scene file.

Mode information display3: Displays the settings assigned to the GAIN button ([GAIN L]/[GAIN M]/[GAIN H]), the White Balance mode settings assigned to the WHITE BAL button ([WHITE BAL A]/[WHITE BAL B]/[WHITE BAL PRST]), and the setting status of the White Balance modes [Ach] and [Bch] ([AWB A]/[AWB B]).

Mode information display4: Displays the settings for [OUTPUT SEL], [REMOTE REC], [REMOTE REC LINK], [HDMI TC OUTPUT], [CAMERA NUMBER], [SUB REC BUTTON] and [SUB ZOOM].

Mode information display5: Displays the settings for [AUDIO LOW CUT CH1], [AUDIO LOW CUT CH2], [AUDIO LEVEL CH1], [AUDIO LEVEL CH2], [INPUT1 LINE LEVEL], [INPUT2 LINE LEVEL], [INPUT1 MIC LEVEL] and [INPUT2 MIC LEVEL].



Using Operation Icons

You can use convenient functions just by the easy operation of touching the screen.

1 Touch the LCD monitor in the recording screen.

- The operation icons are displayed.

2 Touch an operation icon.

- The following function is available. Refer to the respective pages for the operation.



F1: , F2: etc.	Scene number of [FILE SELECT] (→ 152)
DRS , PRE-REC etc.	USER Button Icon (→ 85)

- If you touch the screen while an operation icon is being displayed or do not touch the icon for a certain period, it will disappear. To display again, touch the screen.

Using of jog dial

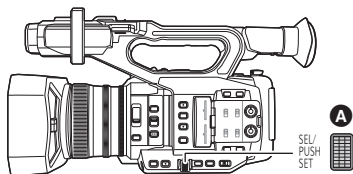

A Jog dial

Selecting/setting items

You can select and set menu items (→ 41), etc. using the jog dial.

1 Rotate the jog dial on the menu screen, etc., to move the cursor.

- The selected item will be displayed in yellow.

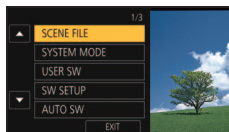

2 Push the jog dial to set.



Menu operations for setting a value

When a menu that lets you set a value is displayed, select the value display before adjusting the setting.

- You cannot select / / / with the jog dial when a screen that lets you adjust a value is displayed.

(Example: When adjusting the brightness for [LCD SET])

1 Rotate the jog dial to move the cursor to the value display **A**.

- Push the jog dial to select the value display.

2 Rotate the jog dial to adjust the setting.

- Pushing the jog dial will set the value you have selected.

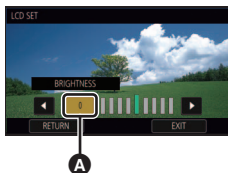

- The jog dial also allows you to select/set operation icons, thumbnails, etc.
- Parts that are finger-touch sensitive can be operated with the jog dial. (Excluding some functions)

Using the multi manual function

You can select the following functions and adjust their settings using the jog dial.
You can also switch between the functions and adjust their settings.

(When the recording screen is displayed)

On-screen icons	Functions	Settings
GAIN	Gain adjustment (→ 70)	Adjusts the gain value.
VAR	VAR adjustment (→ 67)	Adjusts the VAR setting of the White Balance.
AF AREA	AF Area Width Adjustment (→ 56)	Adjusts the size of the AF area frame.
VFR	Variable Frame Rate (→ 102)	Changes the frame rate for Variable Frame Rate Mode.
SHUTTER	Shutter speed (→ 72)	Adjusts the shutter speed.
AREA	Area Mode (→ 92)	Changes the area frame setting.
ASSIST	Focus Assist (→ 57)	Changes the magnification level of the magnified display
VOLUME	Headphone Volume Adjustment (→ 114)	Adjusts the headphone volume.
ICONS	Allows you to display/select operation icons on the recording screen.	—

(When the playback screen is displayed)

On-screen icons	Functions	Settings
VOLUME	Volume adjustment (→ 117)	Adjusts the speaker and headphone volume during motion picture playback.
ICONS	Allows you to display/select operation icons on the playback screen.	—

To change the function you adjust

- 1 Change settings in advance so that you can select more than two functions.

- Change settings as follows:

Functions	Settings to be changed in advance
Gain adjustment	Switch to Manual Mode. (→ 45)
VAR adjustment	Press the WHITE BAL button and the USER button to which [AWB] is registered to set the White Balance mode to [VAR]. (→ 64)
AF Area Width adjustment	Press the USER button to which [AF AREA] is registered to enable AF Area Setting Adjustment or set [AF AREA WIDTH] to [SET] using the menu. (→ 56, 101)
Variable Frame Rate	Press the USER button to which [VFR] is registered to enable Variable Frame Rate Mode or set [VFR MODE] to [ON] using the menu. (→ 102, 184)
Shutter speed	Press the SHUTTER button to enable Manual Shutter Mode. (→ 72)
Area Mode	Press the applicable USER button to enable Area Mode. (→ 92)
Focus Assist	Set [FOCUS ASSIST 1] or [FOCUS ASSIST 2] to [EXPAND] or [BOTH]* and press the FOCUS ASSIST button or the applicable USER button to set Focus Assist to ON. (→ 57) * This item is only set in [FOCUS ASSIST 1].
Headphone Volume Adjustment	Connect headphones to this unit.

- The on-screen icon for the selected function is displayed in white. (Function Execution Mode)
If you have selected [⚙️ ICONS], you can rotate the jog dial to select an operation icon.

2 Push the jog dial.

- The on-screen icon turns yellow. (Function Selection Mode)

3 Rotate the jog dial to select the function you want to adjust, and press the jog dial to set the selection.

- The on-screen icon for the selected function turns white. (Function Execution Mode)
- You can rotate the jog dial to adjust the setting of the selected function.

■ Headphone Volume Adjustment

Adjust the volume of the headphone while recording.

- Set [VOLUME] to [ON]. (→ 191)

1 Connect headphones to the headphone terminal.

2 Rotate the jog dial to adjust the volume.

- Actual volume to be recorded does not change.

3 Push the jog dial to finish the adjustment.



A

A [VOLUME]

- You can also adjust the volume by touching ◀/▶ in Step 2. Not performing touch operations after the adjustment allows you to exit the setting.



Motion picture/Still picture playback

- 1 Set this unit to playback mode. (→ 32)
- 2 Touch the play mode select icon **A**.

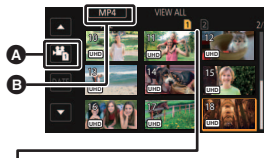

Media display

The selected media is displayed in yellow.

- 3 Select the media **C** you wish to play back.

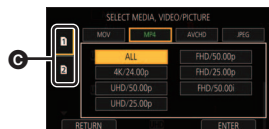

- 4 (To set this unit to Motion Picture Playback Mode)
Touch the desired recording mode **D** and recording format **E** for playback.

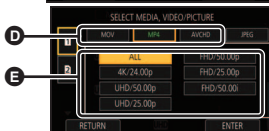

- Recording mode options with recorded scenes are displayed in green.
- The available recording format options differ depending on [SYSTEM FREQ] (→ 198) or the recording mode option you have touched.
- Next (Previous) page can be displayed by touching / .
- Touch [ENTER].
- A recording mode icon **B** will be displayed on the thumbnail display. (/ /)

(If you have touched the recording mode option [MOV] or [MP4])

- After you have touched a recording format option, one of the following icons will be displayed on each thumbnail. The icon to be displayed differs depending on the size of recording format.
 - : Scenes recorded in 4K (4096×2160)
 - : Scenes recorded in UHD (3840×2160)
 - : Scenes recorded in FHD (1920×1080)
 - : Scenes recorded as sub recordings with [DUAL CODEC REC] set to [FHD 50Mbps] (→ 178, 182)
 - : Scenes recorded as sub recordings with [DUAL CODEC REC] set to [FHD 8Mbps] (→ 178, 182)
- If you touch the recording format option [ALL], all scenes of the same recording mode in the selected media are displayed.
The thumbnails of scenes with a different system frequency are indicated with . You can play them back by changing the [SYSTEM FREQ] setting. (→ 198)



- (If you have touched the recording mode option [AVCHD])
After you have touched a recording format option, one of the following icons will be displayed on each thumbnail.
 - [PS] : Scenes recorded in [PS 1080/59.94p]/[PS 1080/50.00p]
 - [PH] : Scenes recorded in [PH 1080/59.94i]/[PH 1080/23.98p]/[PH 1080/50.00i]
 - [HA] : Scenes recorded in [HA 1080/59.94i]/[HA 1080/50.00i]
 - [HE] : Scenes recorded in [HE 1080/59.94i]/[HE 1080/50.00i]
 - [PM] : Scenes recorded in [PM 720/59.94p]/[PM 720/50.00p]
 - [SA] : Scenes recorded in [SA 480/59.94i]/[SA 576/50.00i]

(To set this unit to Still Picture Playback Mode)

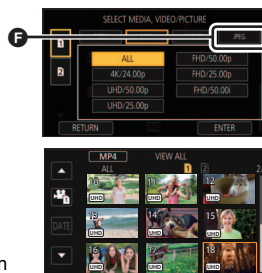
Touch the still picture (JPEG)



5 Touch the scene or the still picture to be played back.









- Next (Previous) page can be displayed by touching  / .
- You can change the playback media by pressing the USER button to which [SLOT SEL] is registered. (→ 84)



6 Select the playback operation by touching the operation icon.



Operation icon

- If you touch the screen while an operation icon is being displayed or do not touch the icon for a certain period, it will disappear. To display again, touch the screen.

Motion picture playback	Still picture playback
<p>: Playback/Pause</p> <p>: Fast rewind playback*</p> <p>: Fast forward playback*</p> <p>: Stops the playback and shows the thumbnails.</p>	<p>: Slide show (playback of the still pictures in numerical order) start/pause.</p> <p>: Plays back the previous picture.</p> <p>: Plays back the next picture.</p> <p>: Stops the playback and shows the thumbnails.</p>

* When touched twice, the fast forward/fast rewind speed increases. (Screen display will change to  /  .)

Change the thumbnail display

While the thumbnail is displayed, the thumbnail display changes in the following order if the zoom lever or the sub zoom lever is operated to **Q** side or **W** side.

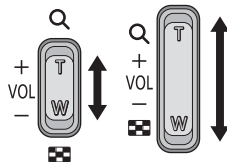

(**W** side)

(**Q** side)

20 scenes ↔ 9 scenes ↔ 1 scene ↔ Scene information display*

* Detailed information of the scene is displayed when playing back motion pictures. Following information is displayed.

START TC, START UB, and DURATION are displayed only for AVCHD scenes.

- START TC
- START UB
- DATE
- TIME ZONE
- DURATION
- REC MODE
- FORMAT

- If you press the THUMBNAIL button to switch between Recording Mode and Playback Mode, the thumbnails of 9 scenes will be displayed.
- By displaying in 1 scene, recording date and time are displayed when playing back motion pictures, and recording date and file number when playing back still pictures.

Speaker/Headphone volume adjustment

Operate the volume lever, sub zoom lever or jog dial to adjust the speaker/headphone volume during Motion Picture Playback Mode.

Adjusting the volume with the volume lever/sub zoom lever

Towards “+”:

Increases the volume

Towards “-”:

Decreases the volume

A [VOLUME]

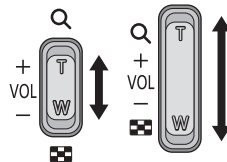
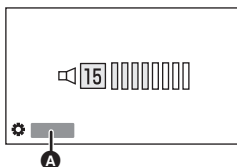

Adjusting the volume with the jog dial

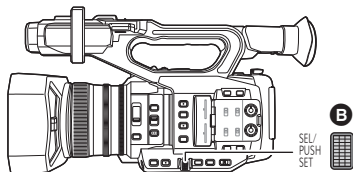

B Jog dial

- 1 Push the jog dial while [ VOLUME] is displayed.
- 2 Rotate the jog dial to adjust the volume.

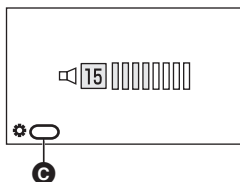

 [VOLUME]

- 3 Push the jog dial to finish the adjustment.

- Sound will be heard only during normal motion picture playback.
- If pause play is continued for 5 minutes, the screen returns to the thumbnails.
- In the following cases, when you select the desired recording format for playback, this unit will be restarted to switch the system frequency:
 - When you have switched recording format from [4K/24.00p] to a different option.
 - When you have switched recording format from an option other than [4K/24.00p] to [4K/24.00p]
- If you set recording format to [ALL] and play back a scene, the screen may turn dark momentarily when it switches to another scene.

Motion picture compatibility









- This unit is based on AVCHD Progressive/AVCHD.
- Even if the devices used have compatible standards, when playback of video recorded using another device is performed using this device, or when video recorded using this device is played back in another device, playback may not proceed normally, or may not be possible. (Please check compatibility in the instruction manual of your device.)
- Motion pictures recorded with devices other than this unit are not supported by this unit.

Still picture compatibility

- This unit is compliant with the unified standard DCF (Design rule for Camera File system) established by JEITA (Japan Electronics and Information Technology Industries Association).
- The file format of still pictures supported by this unit is JPEG. (Not all JPEG formatted files will be played back.)
- This unit may degrade or not play back still pictures recorded or created on other products and other products may degrade or not play back still pictures recorded on this unit.
- Depending on the playback device, still pictures may be played back with picture sizes different from the ones with which they were recorded.

Motion picture playback using operation icon

For details on the basic playback operations, refer to page 115.

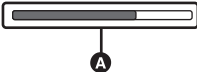
Playback operation	Playback display	Operating steps
Skip playback (to the start of a scene)	<p>During Playback</p> 	<p>Touch the LCD monitor and slide from right to left (from left to right) during playback.</p>
Slow-motion Playback	<p>During Pause</p> 	<p>With the playback paused, continue touching .</p> <p>( is for slow rewind playback.)</p> <p>Slow-motion Playback is performed continuously while the display is touched and held.</p> <ul style="list-style-type: none"> Normal playback is restored when you touch . For slow rewind playback, the intervals between frames and the display time per frame vary depending on the type of the scene.
Frame-by-frame Playback	<p>During Pause</p> 	<p>With the playback paused, touch .</p> <p>(Touch  to advance the frames one at a time in the reverse direction.)</p> <ul style="list-style-type: none"> Normal playback is restored when you touch . For reverse Frame-by-frame Playback, the intervals between frames vary depending on the type of the scene.
Direct playback	<p>During Pause</p> 	<p>Touch the direct playback bar A or slide it while touching.</p> <ul style="list-style-type: none"> The playback pauses temporarily and skips to the position touched or slid to while touching. (When you touch the bar or slide it while touching during playback) Playback will start by releasing your touching or sliding finger.

- Scenes that are large in file size may cause this unit to respond slower to operations performed by the user or cause certain operations performed by this unit to become slower.

Useful functions

Creating still picture from motion picture

You can save a frame of a recorded motion picture as a still picture. The picture size with which a still picture will be recorded differs depending on the picture size of [REC FORMAT] with which the motion picture was recorded.

Recording format	Aspect ratio	Picture size
[REC FORMAT] setting with a size of 4K (4096×2160)	17:9	8.8M 4096×2160
[REC FORMAT] setting with a size of UHD (3840×2160)	16:9	8.3M 3840×2160
[REC FORMAT] setting with a size of FHD (1920×1080)		2.1M 1920×1080
[PS 1080/59.94p]/[PS 1080/50.00p]/ [PH 1080/59.94i]/[PH 1080/23.98p]/ [PH 1080/50.00i]/ [HA 1080/59.94i]/[HA 1080/50.00i]/ [HE 1080/59.94i]/[HE 1080/50.00i]		
[PM 720/59.94p]/[PM 720/50.00p]		0.9M 1280×720

While playing back a motion picture, touch the  at the scene you want to save it as a still picture.

- When still pictures are being recorded, the remaining recordable number of still pictures and the still picture indication  are displayed.
- It is convenient to use Pause, Slow-motion Playback and Frame-by-frame Playback.
- Date the motion picture was recorded will be registered as date of the still picture.



■ About the screen indications while recording still pictures



1 / 2 (White)	Card slot selected for still picture recording (→ 197)
8.3M	Size of still pictures
R3000	Remaining number of still pictures
 (Red)	Still picture indication (→ 206)

- Maximum number of recordable pictures that can be displayed is 9999. If the number of recordable pictures exceeds 9999, R 9999+ is displayed. The number will not change when the picture is taken until the number of recordable pictures is 9999 or less.
- When playing back a still picture recorded with this unit in the 17:9 aspect, black bands appear on the top and bottom of the screen.
- The 17:9 or 16:9 still pictures recorded using this unit may be cropped at the edges when printed. So, be sure to check before printing in the store or on your printer.
- Please refer to page 226 about approximate number of recordable pictures.

Repeat Playback

Playback of the first scene starts after playback of the last scene finishes.

Select the menu.

MENU : [VIDEO SETUP] → [REPEAT PLAY] → [ON]

The  indication appears on the full screen views.

- All the scenes displayed in the thumbnail will be repeatedly played back.

- Repeat Playback cannot be used for the slide show playback of the still pictures. (→ 116)

Resuming the previous playback

If playback of a scene was stopped halfway, the playback can be resumed from where it was stopped.

Select the menu.

MENU : [VIDEO SETUP] → [RESUME PLAY] → [ON]

If playback of a motion picture is stopped,  appears on the thumbnail view of the stopped scene.

- The memorized resume position is canceled if one of the following operations is performed ([RESUME PLAY] will not be set to [OFF]):
 - If you turn the unit off
 - If you press the THUMBNAIL button
 - Changing the recording mode and recording format for playback in Playback Mode

Playing back scenes or still pictures by date

The scenes or still pictures recorded on the same day can be played back in succession.

- 1 Touch the date select icon.

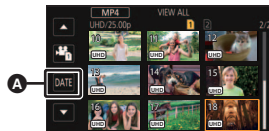











A Date select icon

2 Touch the playback date.

- The scenes or still pictures recorded on the date selected are displayed as thumbnails.

3 Touch the scenes or still picture to be played back.

- Dates cannot be selected while the thumbnail screen for the recording format [ALL] of the recording mode [MOV]/[MP4] is displayed.
- If you press the THUMBNAIL button to switch between Recording Mode and Playback Mode, the thumbnails of all scenes will be displayed.
- In cases such as those described below, scenes and still pictures are grouped separately on the date list, and -1, -2... may be added after the date:
 - When the number of scenes exceeds 99
 - When the number of still pictures exceeds 999
 - When you change the [REC FORMAT] setting (→ 162)
 - When you set [REC MODE] to [AVCHD] and set Interval Recording to an option other than [OFF] (→ 183)
 - When you set [REC MODE] to [MOV] or [MP4] and change the system frequency (→ 161)
 - When [NUMBER RESET] is performed (→ 199)
- Scenes recorded with the following [REC FORMAT] settings are grouped separately on the date list. A recording format icon will be displayed next to the date.

Recording format	Icon to be displayed
[REC FORMAT] setting with a size of 4K (4096×2160)	
[REC FORMAT] setting with a size of UHD (3840×2160)	
[REC FORMAT] setting with a size of FHD (1920×1080)	
Scenes recorded as sub recordings with [DUAL CODEC REC] set to [FHD 50Mbps] (→ 178, 182)	
Scenes recorded as sub recordings with [DUAL CODEC REC] set to [FHD 8Mbps] (→ 178, 182)	
[PS 1080/59.94p]/[PS 1080/50.00p]	
[PH 1080/59.94i]/[PH 1080/23.98p]/[PH 1080/50.00i]	
[HA 1080/59.94i]/[HA 1080/50.00i]	
[HE 1080/59.94i]/[HE 1080/50.00i]	
[PM 720/59.94p]/[PM 720/50.00p]	
[SA 480/59.94i]/[SA 576/50.00i]	

-  is displayed after the date in the list by date for the still pictures created from the motion picture. (→ 120)



Deleting scenes/still pictures

Deleted scenes/still pictures cannot be restored, so perform appropriate confirmation of the contents before proceeding with deletion.

- Press the THUMBNAIL button to switch this unit to the Playback Mode. (→ 32)
- To delete the scene or still picture being played back

Touch  while scenes or still pictures to be deleted are being played back.



■ To delete scenes or still pictures from the thumbnail display

- Switch to the thumbnail display of the scenes or still pictures to delete. (→ 115)

1 Select the menu.

: [VIDEO SETUP] or [PICT. SETUP] → [DELETE] → desired setting

[ALL SCENES]:

All the scenes or still pictures displayed as thumbnails can be deleted.
(When playing back scenes or still pictures by date, all scenes or still pictures of the selected date will be deleted.)

[MULTI]:

Multiple scenes or still pictures can be selected and deleted.

[SINGLE]:

Single scene or still picture can be selected and deleted.

- Protected scenes/still pictures cannot be deleted.

2 (When [MULTI] is selected in Step 1)

Touch the scene/still picture to be deleted.

- When touched, the scene/still picture is selected and the  indication appears on the thumbnail. Touch the scene/still picture again to cancel the operation.
- Up to 99 scenes can be selected to be deleted.

(When [SINGLE] is selected in Step 1)

Touch the scene/still picture to be deleted.

3 (When [MULTI] is selected in Step 1)

Touch [Delete].

- To continuously delete other scenes/still pictures, repeat Steps 2-3.

When you stop deleting halfway:

Touch [CANCEL] or press MENU button while deleting.

- The scenes or still pictures that have already been deleted when the deletion is canceled cannot be restored.

To complete editing:

Touch [Return] or press MENU button.

-
- The following scenes/still pictures cannot be deleted:
 - Scenes/still pictures that cannot be played back (the thumbnails are displayed as )
 - In case of [ALL SCENES], the deletion may take time if there are many scenes or still pictures.
 - If you delete scenes recorded on other products or still pictures conforming to DCF standard with this unit, all the data related to the scenes/still pictures may be deleted.
 - When still pictures recorded on an SD card by other products are deleted, a still picture (other than JPEG) that cannot be played back on this unit, may be erased.

Protecting scenes/still pictures



Scenes/still pictures can be protected so that they are not deleted by mistake.

(Even if you protect some scenes/still pictures, formatting the SD card will delete them.)

- Press the THUMBNAIL button to switch this unit to the Playback Mode. (→ 32)

1 Select the menu.

 : [VIDEO SETUP] or [PICT. SETUP] → [SCENE PROTECT]

2 Touch the scene/still picture to be protected.

- When touched, the scene/still picture is selected and the  indication appears on the thumbnail. Touch the scene/still picture again to cancel the operation.
- Touch [Return] to complete the settings.



Copying between SD cards

Motion pictures or still pictures recorded with this unit can be copied between SD Cards inserted in this unit.

- Copying is not possible if the type of the source SD card (SDHC Memory Card/SDXC Memory Card) is different from that of the target SD card.

■ Check the used space of the copy destination

It is possible to check the used space of the SD Card by [MEDIA STATUS]. (→ 197)

- By displaying in 1 scene, recording date and time can be checked when playing back motion pictures, and recording date and file number when playing back still pictures.
- Depending on the media condition, some remaining capacity of the SD Card may not be used.

Copying

1 Press the THUMBNAIL button to switch this unit to the Playback Mode.

- Use a sufficiently charged battery or the AC adaptor.

2 Select the menu.

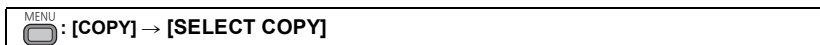

- [1 → 2]: Copies from card 1 to card 2
- [2 → 1]: Copies from card 2 to card 1
- [1 →]*: Copies from card 1 to an external media device
- [2 →]*: Copies from card 2 to an external media device

* Displayed only when the external media is connected. (→ 138)

3 Touch desired items following the screen display.

- It will return to the previous step by touching [Return].
- (When [SELECT SCENES] is selected)
When touched, the scene/still picture is selected and the indication appears on the thumbnail. Touch the scene/still picture again to cancel the operation.
- (When [SELECT DATE] is selected)
When touched, the date is selected and surrounded by red. Touch the date again to cancel the operation.
- Up to 99 scenes/still pictures or 99 dates can be set in succession.

4 Touch [EXIT] when the copy complete message is displayed.

- The thumbnail view of the copy destination is indicated.

When you stop copying halfway

Touch [CANCEL] while copying.

If you will delete the motion pictures or still pictures after copying is complete, be sure to play back the motion pictures or still pictures to check that they have been copied to correctly before deleting.

- Depending on the following conditions, the time it takes for copying may be longer.
 - The number of recorded scenes is large.
- If some motion pictures or still pictures have already been recorded to the copy destination, then the same date may be assigned or images may not display by date when the list by date is selected.
- Motion pictures that have been recorded on another device may not be copied. Data recorded on a PC cannot be copied.
- The settings for the copied motion pictures and still pictures will be cleared if the protected motion pictures or still pictures are copied.
- The order in which the scenes or still pictures were copied cannot be changed.

Connecting Headphones, a Remote Control or an External Monitor

Headphones

You can connect headphones (commercially-available) to the headphone output jack (3.5 mm diameter stereo mini jack).

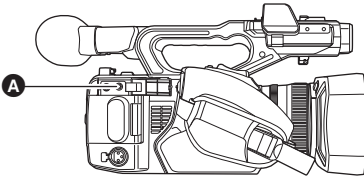

A Headphone output jack

- Sound is not output from the speaker when headphones are connected.

Remote control



You can connect a remote control (commercially-available) to either of the CAM REMOTE terminals (FOCUS IRIS or ZOOM S/S).

- Connecting a remote control to the FOCUS IRIS terminal (3.5 mm diameter mini jack) allows you to remotely control the focus and iris.
- Connecting a remote control to the ZOOM S/S terminal (2.5 mm diameter super-mini jack) allows you to remotely control the zoom and start/stop recording.

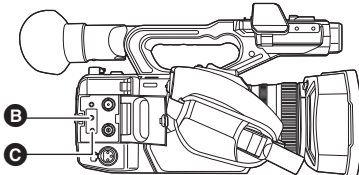

B FOCUS IRIS terminal
C ZOOM S/S terminal

- Do not connect any device other than a remote control to the CAM REMOTE terminals. Doing so may change the image brightness or cause the image to be out of focus.

(When a remote control is connected to the FOCUS IRIS terminal)

- Priority for iris adjustment is given to the remote control. It is not possible to adjust the iris with the iris ring of this unit.
- If you switch to Auto Mode when [A.IRIS] is set to [ON], the remote control cannot be used.

External monitor

You can connect this unit to an external monitor as shown in the figure below.

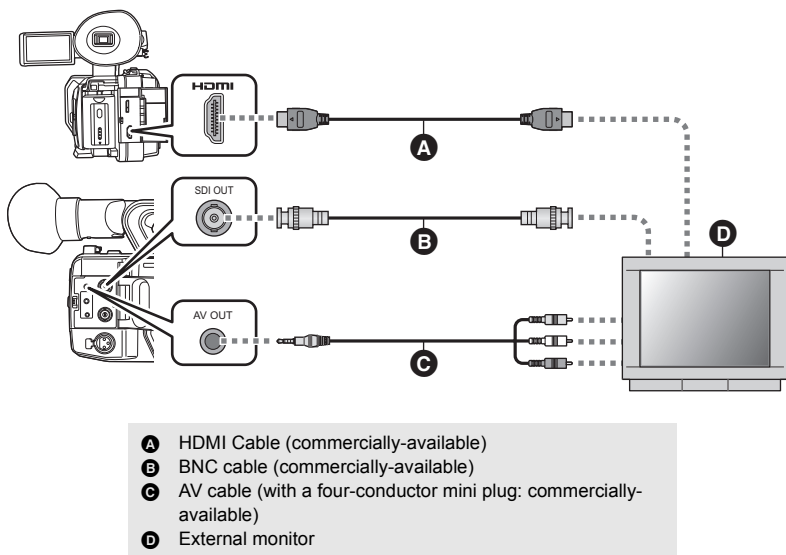

- By connecting this unit to an external monitor that supports 4K motion picture with an HDMI cable and play back scenes recorded with their size in [REC FORMAT] set to 4K (4096×2160) or UHD (3840×2160), you can enjoy finely-detailed 4K motion pictures. If 4K motion picture is not supported on your external monitor, you can change the [RESOLUTION] setting so that 4K motion pictures can be played back at a lower resolution.
- To play back scenes recorded with a [REC FORMAT] setting of [UHD 2160/59.94p 150M] or [UHD 2160/50.00p 150M], an external monitor that supports 4K/60p (50p) is required. If 4K/30p (25p) is supported on your external monitor, you can change the [HDMI UHD OUTPUT LIMIT] setting so that 4K motion pictures can be played back at a lower output frame rate. (→ 190)
- If you set [REC FORMAT] to [UHD 2160/59.94p 150M] or [UHD 2160/50.00p 150M] in Recording Mode and then connect this unit to a 4K-compatible external monitor with an HDMI cable, images will be output in 3840×2160 when recording is stopped and in 1920×1080 during recording or PRE-REC. Please note that the image on the screen of this unit and on the external monitor disappears for a few seconds every time you start or stop recording or every time you switch the PRE-REC on/off. These irregularities do not occur when [RESOLUTION] is set to [1080p] or [1080i], which outputs images in 1920×1080.

**When connecting with an HDMI cable using an HDMI-to-DVI converter, etc., be sure to connect the HDMI cable to the connector of this unit last.
Connecting the HDMI cable to the connector of this unit first may result in malfunction.**

- This unit is not compatible with the VIERA Link.
 - Use a commercially-available High Speed HDMI cable.
If possible, we recommend using a cable with a length of 3 m or less.
 - Use a commercially-available, double-shielded BNC cable equivalent to 5C-FB.
 - If you connect this unit to the external monitor when this unit is set to Recording Mode, a squealing sound* may be output. Before connecting this unit, set it to Playback Mode.
- * The microphone may pick up the sound from the speakers, producing an abnormal sound.

■ To watch images on an external monitor (4:3) or when both sides of the images do not appear on the screen

Change the menu setting to display the images correctly. (Check the external monitor setting.)
Select the menu.



MENU : [OUTPUT SETUP] → [RESOLUTION] → [DOWN CONV.]

MENU : [OUTPUT SETUP] → [DOWN CONV.] → desired setting

[SIDE CROP]:	Outputs images so that they are fit to the height of the external monitor screen.
[LETTERBOX]:	Outputs images so that they are fit to the width of the external monitor screen.
[SQUEEZE]:	Outputs an image by compressing it in the horizontal direction to fit it in the screen.

- This item is fixed to [SQUEEZE] in the following cases:
 - When [REC FORMAT] is set to a setting with a size of UHD (3840×2160)
 - When [REC FORMAT] is set to [SA 480/59.94i] or [SA 576/50.00i]

Example of images with a [17:9] or [16:9] aspect ratio on an external monitor (4:3):

[DOWN CONV.] setting	
[LETTERBOX]	[SQUEEZE]
	

- When [DOWN CONV.] is set to [SIDE CROP], the sides of an image will be cut off, causing some icons on the external monitor to be hidden from the external monitor screen.

■ To display the on-screen information on the external monitor

When the menu setting is changed, the information displayed on the screen (operation icon and Counter displayed etc.) can be displayed/not displayed on the external monitor.

MENU : [DISP SETUP] → [VIDEO OUT OSD] → [ON] or [OFF]

- This item is set to [OFF] in the following situations when this unit is in Recording Mode:
 - When [REC FORMAT] is set to a setting with a size of 4K (4096×2160) or UHD (3840×2160) (→ 162)
 - During auto recording (→ 100, 189)

Setting the external output resolution

Change the setting for outputting images to an external monitor or other external device (recorder, etc.).

1 Select the [OUTPUT SEL] menu.

 : [OUTPUT SETUP] → [OUTPUT SEL] → desired setting

[HDMI]: Select this setting when connecting to the HDMI OUT terminal.

[SDI]: Select this setting when connecting to the SDI OUT terminal.

[AV]: Select this setting when connecting to the AV OUT terminal.

2 Select the [RESOLUTION] menu.

 : [OUTPUT SETUP] → [RESOLUTION] → desired setting

[SYSTEM]/[1080p]/[1080i]/[DOWN CONV.]

- [SYSTEM] automatically sets the output resolution according to the setting in [REC FORMAT]. If the images are not output on the external device when the setting is [SYSTEM], switch to the method [1080p], [1080i] or [DOWN CONV.] which enables the images to be displayed on your external device. (Please read the operating instructions for the external device.)
 - [DOWN CONV.] outputs images in standard picture quality.
-
- Images may not be displayed on the external device for several seconds in some cases, such as when changing between scenes.
 - When this unit and an external monitor are connected with an AV cable, scenes with a [REC FORMAT] size of 4K (4096×2160) are not output.
 - If the size in [REC FORMAT] is set to 4K (4096×2160), [RESOLUTION] cannot be set to [1080i] or [DOWN CONV.]. If the size in [REC FORMAT] is set to a different value and [RESOLUTION] is set to [1080i] or [DOWN CONV.], the [RESOLUTION] setting will change to [SYSTEM].
 - When [REC FORMAT] is set to [SA 480/59.94i] or [SA 576/50.00i], [RESOLUTION] is fixed to [SYSTEM].
 - [RESOLUTION] cannot be set during Freeze Frame. (→ 91)
 - If you set [OUTPUT SEL] to [AV], [RESOLUTION] will be fixed to [DOWN CONV.].
 - When the size in [REC FORMAT] is set to 4K (4096×2160), the following limitations apply:
 - If you set [OUTPUT SEL] to [SDI], [RESOLUTION] will be fixed to [1080p].
 - [OUTPUT SEL] cannot be set to [AV].

About external output resolutions

The external output resolution varies depending on the [RESOLUTION] setting and connected terminal.

- When [RESOLUTION] is set to [SYSTEM], the external output resolution varies depending on the picture size and frame rate in [REC FORMAT].

(When [SYSTEM FREQ] is set to [59.94Hz])

Setting		External output resolution		
Picture size/Frame rate in [REC FORMAT]	[RESOLUTION] setting	HDMI OUT terminal	SDI OUT terminal	AV OUT terminal
4K (4096×2160)/24.00p	[SYSTEM]	2160/24.00p	—	—
	[1080p]	1080/24.00p	1080/24.00PsF	
UHD (3840×2160)/59.94p	[SYSTEM]	2160/59.94p ^{*1}	1080/59.94p	—
	[1080p]	1080/59.94p		
	[1080i]	1080/59.94i		
	[DOWN CONV.]	480/59.94p	480/59.94i	
UHD (3840×2160)/29.97p	[SYSTEM]	2160/29.97p	1080/29.97PsF	—
	[1080p]	1080/59.94p		
	[1080i]	1080/59.94i		
	[DOWN CONV.]	480/59.94p	480/59.94i	
UHD (3840×2160)/23.98p	[SYSTEM]	2160/23.98p	1080/23.98PsF	—
	[1080p]	1080/59.94p		
	[1080i]	1080/59.94i		
	[DOWN CONV.]	480/59.94p	480/59.94i	
FHD (1920×1080)/59.94p, PS 1080/59.94p	[SYSTEM]	1080/59.94p		—
	[1080p]	1080/59.94p		
	[1080i]	1080/59.94i		
	[DOWN CONV.]	480/59.94p	480/59.94i	
FHD (1920×1080)/59.94i, PH 1080/59.94i, HA 1080/59.94i, HE 1080/59.94i	[SYSTEM]	1080/59.94i		—
	[1080p]	1080/59.94p		
	[1080i]	1080/59.94i		
	[DOWN CONV.]	480/59.94p	480/59.94i	
FHD (1920×1080)/29.97p	[SYSTEM]	1080/29.97p	1080/29.97PsF	—
	[1080p]	1080/59.94p		
	[1080i]	1080/59.94i		
	[DOWN CONV.]	480/59.94p	480/59.94i	

*1 2160/59.94p of 4:2:0 (8 bit). When recording motion pictures with this unit, 1080/59.94p of 4:2:2 (8 bit) will be set.

Setting		External output resolution		
Picture size/Frame rate in [REC FORMAT]	[RESOLUTION] setting	HDMI OUT terminal	SDI OUT terminal	AV OUT terminal
FHD (1920×1080)/ 23.98p, PH 1080/23.98p	[SYSTEM]	1080/23.98p	1080/23.98PsF	-
	[1080p]	1080/59.94p		
	[1080i]	1080/59.94i		
	[DOWN CONV.]	480/59.94p	480/59.94i	
PM 720 (1280×720)/ 59.94p	[SYSTEM]	720/59.94p		-
	[1080p]	1080/59.94p		
	[1080i]	1080/59.94i		
	[DOWN CONV.]	480/59.94p	480/59.94i	
SA 480 (720×480)/ 59.94i	[SYSTEM]	480/59.94p	480/59.94i	

(When [SYSTEM FREQ] is set to [50.00Hz])

Setting		External output resolution		
Picture size/Frame rate in [REC FORMAT]	[RESOLUTION] setting	HDMI OUT terminal	SDI OUT terminal	AV OUT terminal
4K (4096×2160)/24.00p	[SYSTEM]	2160/24.00p	-	-
	[1080p]	1080/24.00p	1080/24.00PsF	
UHD (3840×2160)/ 50.00p	[SYSTEM]	2160/50.00p ^{*2}	1080/50.00p	-
	[1080p]	1080/50.00p		
	[1080i]	1080/50.00i		
	[DOWN CONV.]	576/50.00p	576/50.00i	
UHD (3840×2160)/ 25.00p	[SYSTEM]	2160/25.00p	1080/25.00PsF	-
	[1080p]	1080/50.00p		
	[1080i]	1080/50.00i		
	[DOWN CONV.]	576/50.00p	576/50.00i	
FHD (1920×1080)/ 50.00p, PS 1080/50.00p	[SYSTEM]	1080/50.00p		-
	[1080p]			
	[1080i]			
	[DOWN CONV.]	576/50.00p	576/50.00i	
FHD (1920×1080)/ 50.00i, PH 1080/50.00i, HA 1080/50.00i, HE 1080/50.00i	[SYSTEM]	1080/50.00i		-
	[1080p]	1080/50.00p		
	[1080i]	1080/50.00i		
	[DOWN CONV.]	576/50.00p	576/50.00i	

*2 2160/50.00p of 4:2:0 (8 bit). When recording motion pictures with this unit, 1080/50.00p of 4:2:2 (8 bit) will be set.

Setting		External output resolution		
Picture size/Frame rate in [REC FORMAT]	[RESOLUTION] setting	HDMI OUT terminal	SDI OUT terminal	AV OUT terminal
FHD (1920×1080)/ 25.00p	[SYSTEM]	1080/25.00p	1080/25.00PsF	—
	[1080p]	1080/50.00p		
	[1080i]	1080/50.00i		
	[DOWN CONV.]	576/50.00p	576/50.00i	
PM 720 (1280×720)/ 50.00p	[SYSTEM]	720/50.00p		—
	[1080p]	1080/50.00p		
	[1080i]	1080/50.00i		
	[DOWN CONV.]	576/50.00p	576/50.00i	
SA 576 (720×576)/ 50.00i	[SYSTEM]	576/50.00p	576/50.00i	

- If you set [RESOLUTION] to [SYSTEM], the external output resolution will be set to 1080/59.94p or 1080/50.00p in the following cases:
 - During Super Slow Recording (→ 105)
 - In Variable Frame Rate Mode (→ 102)

External output resolution for still picture playback

The output resolution varies depending on the system frequency.

Setting		External output resolution		
[SYSTEM FREQ]	[RESOLUTION] setting	HDMI OUT terminal	SDI OUT terminal	AV OUT terminal
[59.94Hz]	[SYSTEM]	1080/59.94p		—
	[1080p]			
	[1080i]	1080/59.94i		
	[DOWN CONV.]	480/59.94p	480/59.94i	
[50.00Hz]	[SYSTEM]	1080/50.00p		—
	[1080p]			
	[1080i]	1080/50.00i		
	[DOWN CONV.]	576/50.00p	576/50.00i	
24.00 Hz*	[SYSTEM]	1080/24.00p	—	—
	[1080p]		1080/24.00PsF	

- * If you select the recording format option [4K/24.00p] in Playback Mode, the system frequency setting will change to 24.00 Hz. (→ 115)



Connecting to a PC (File transfer/nonlinear editing)

When this device and a computer for editing are connected using a USB 3.0 Cable (commercially-available), image data in the SD card can be transferred.

- This unit supports USB 3.0.
- Concerning non-linear editing, refer to the instruction manual of your editing software.
- It is impossible to write data to the SD card on this unit from a PC.

Operating environment (mass storage)

- Even if the system requirements mentioned in these operating instructions are fulfilled, some PCs cannot be used.
- The USB equipment operates with the driver installed as standard in the OS.

■ If using Windows

OS	Windows 10 (32 bit/64 bit) Windows 8.1 (32 bit/64 bit) Windows 7 (32 bit/64 bit) SP1
CPU	1 GHz or higher 32-bit (×86) or 64-bit (×64) processor
RAM	2 GB or more (64 bit)/1 GB or more (32 bit)
Interface	USB port
Other requirements	Mouse or equivalent pointing device

■ If using Mac

PC	Mac
OS	macOS v10.12
CPU	Intel Core 2 Duo or better
RAM	2 GB or more
Interface	USB port
Other requirements	Mouse or equivalent pointing device

Connecting to a PC

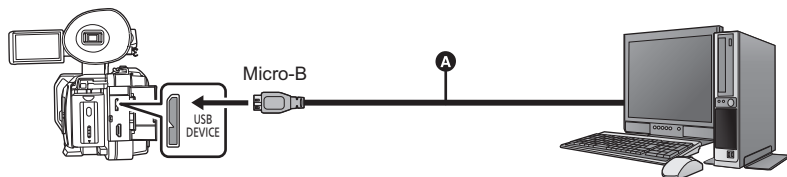

A USB 3.0 Cable (commercially-available)

- Insert the plugs as far as they will go.

1 Connect this unit to the AC adaptor.

- Use the AC adaptor to free you from worrying about the battery running down.

2 Turn on the unit.

3 Set [USB MODE SELECT] to [DEVICE].

MENU
[MENU] : [OTHER FUNCTION] → [USB MODE SELECT] → [DEVICE]

4 Set [USB MODE] to [ON].

MENU
[MENU] : [OTHER FUNCTION] → [USB MODE] → [ON]

5 Connect this unit to a PC.

- The USB function selection screen will appear.

6 Touch [PC] on the screen of this unit.

- This unit is automatically recognized as an external drive of the PC. (→ 136)
- When you select an option other than [PC], reconnect the USB Cable.
- When using the battery, the LCD monitor turns off after about 5 seconds. Touch the screen to turn the LCD monitor on.

-
- A USB 3.0 cable is not supplied with this unit. Use a commercially-available double-shielded USB 3.0 cable with a ferrite core.
If possible, we recommend using a cable with a length of 1.5 m or less.
 - When performing reading/writing between a PC and an SD card, be aware that some SD card slots built into PCs and some SD card readers are not compatible with the SDHC Memory Card or SDXC Memory Card.
 - If you are using an SDXC Memory Card, some PC may not recognize the data. Make sure your PC supports SDXC cards.

■ To disconnect USB Cable safely

(For Windows)

Select the  icon in task tray displayed on the PC, and then select the model number of this unit to disconnect the USB cable.

- Depending on your PC's settings, this icon may not be displayed.

(For Mac)

Drag [CAM_SD] disk icon to the [Trash], and then disconnect the USB Cable.

About the screen indication of the unit

- Do not disconnect the USB Cable, battery, or AC adaptor while the access lamp is on or card access icon () appears on the unit screen.
- If the screen does not change when the unit is operated while connected to a PC, disconnect the battery and/or AC adaptor, wait approximately 1 minute, reconnect the battery and/or AC adaptor, wait approximately 1 minute again, and then turn the unit back on. (Data may be destroyed when above operation is performed while accessing the SD card.)

About the PC display

When the unit is connected to a PC, it is recognized as an external drive.

- Removable disk (Example:  CAM_SD (F:)) is displayed in [Computer].

Data recorded using AVCHD format has excellent compatibility with computers, due to its file form; however, it contains not just image and sound data, but also various important information, and it is associated using a folder structure which is like a figure. If even part of this information is changed or erased, faults may occur; for example, it may not be possible for the data to be recognized as AVCHD data, or it may no longer be possible for the SD card to be used in an AVCHD device.

Data from a computer cannot be written to the SD card of this device.

Example folder structure of a SD card:

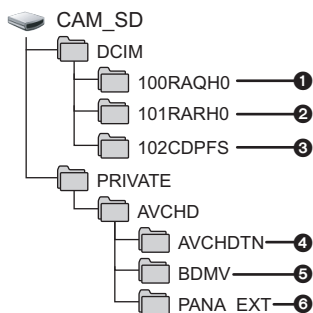

The following data will be recorded.

- ① MOV format motion picture data ([01000001.MOV], etc.)
- ② MP4 format motion picture data ([01010001.MP4], etc.)
- ③ JPEG format still pictures created from the motion picture (Maximum number of recordable pictures: 999 ([01020001.JPG] etc.))
- ④ The motion picture thumbnails
- ⑤ AVCHD format motion picture files ([00000.MTS] etc.)
- ⑥ For management

■ Folder names for motion picture data recorded in MOV/MP4 format

The fourth to eighth characters of the folder name of a recorded MOV/MP4 scene are determined by its picture size, frame rate, motion picture format, recording setting and camera number setting.

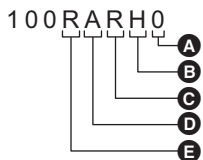

- A** Camera number setting (→ 167)
- B** Recording setting
- C** Motion picture format
- D** Frame rate
- E** Picture size

(Example) If the folder name is 100RARH0:

Motion picture data that has a picture size of 3840×2160, frame rate of 59.94 fps, and motion picture format categorized as progressive recording (MP4 and LPCM) is stored.

Picture size	Y: 1920×1080 R: 3840×2160 Q: 4096×2160
Frame rate	A: 59.94 fps B: 50 fps C: 29.97 fps D: 25 fps E: 24 fps F: 23.98 fps
Motion picture format	J: Interlace recording (MOV, LPCM) K: Interlace recording (MP4, LPCM) Q: Progressive recording (MOV, LPCM) R: Progressive recording (MP4, LPCM)
Recording setting	H: Recordings other than the ones below D: Sub recordings of dual codec recording (50 Mbps) E: Sub recordings of dual codec recording (8 Mbps) P: Main recordings of dual codec recording
Camera number setting	0 to 9: Numbers between 0 and 9 is set in [CAMERA NUMBER SET]. A to G: Numbers between 10 and 16 is set in [CAMERA NUMBER SET].

- Do not delete the SD card's folders on a PC. Doing so may make the SD card unusable in this unit.
- When data not supported by this unit has been recorded on a PC, it will not be recognized by this unit.
- Always use this unit to format SD cards.



Copying/playing back with an external media device

● In these Operating Instructions, “USB hard disk drive” is indicated as “USB HDD”.
If you connect an external media device, such as USB HDD or USB flash memory (commercially-available) to this unit, you can copy motion pictures and still pictures recorded on this unit to an external media device.

It can also play back the scenes and still pictures copied to the external media device.

- This unit supports USB 3.0.
- You can copy scenes and still pictures recorded with this unit while maintaining the image quality.
- Please read the operating instructions of the external media device for how to use it.

Preparing for copying/playing back

Refer to the following support site for information about an external media device.

<http://pro-av.panasonic.net/>

(This Site is English only)

When the external media device that requires formatting is connected, a message is displayed. Follow the instructions on the screen to format it.

Once the external media device has been formatted, all data stored on it will be deleted. The data cannot be recovered.

This unit formats the external media device in exFAT*.

- In the following cases, an external media device cannot be used by connecting it to this unit:
 - An external media device with a capacity below 32 GB or above 2 TB
 - When an external media device has two or more partitions
 - If an external media device is in a format other than FAT32 or exFAT*
 - When connected by using a USB hub
- * FAT32 is a format used for SDHC memory cards.
exFAT is a format used for SDXC memory cards.
- You cannot copy scenes recorded on an SDXC Memory Card to an external media device in FAT32 format.

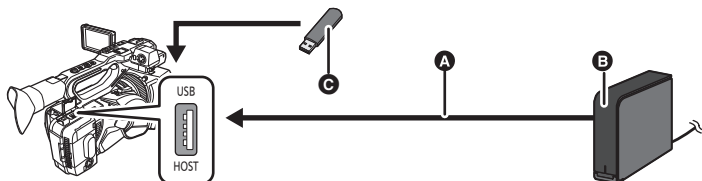

- A** Connect this unit to the USB HDD with USB Cable (supplied with the USB HDD)
- B** USB HDD (commercially-available)
- C** USB flash memory (commercially-available)

1 (When using USB HDD)

Connect the AC adaptor (supplied with USB HDD) to the USB HDD.

- If you are using a bus-powered or portable USB HDD, this unit can supply power to the USB HDD by USB Cable (supplied with USB HDD).

2 Connect the AC adaptor to this unit.

- Use the AC adaptor to free you from worrying about the battery running down.

3 Turn on this unit, and press the THUMBNAIL button to switch to Playback Mode.

4 Set [USB MODE SELECT] to [HOST].

 : [OTHER FUNCTION] → [USB MODE SELECT] → [HOST]

5 Set [USB MODE] to [ON].

 : [OTHER FUNCTION] → [USB MODE] → [ON]

6 Connect the external media device to the USB HOST terminal of this unit.

- If you use a USB HDD, connect to the USB HDD with the USB Cable supplied with the USB HDD.
- It may take several minutes until the connection is completed.

7 Touch the desired item.

[COPY ONCE]:	Copies all scenes and still pictures recorded with this unit that have not been copied yet. (→ 141)
[SELECT COPY]:	Allows you to select desired scenes/still pictures, and then copy. (→ 141)
[Playback from External Media]:	Plays back scenes and still pictures stored in an external media device on this unit. (→ 142)
[Safe Removal]:	Allows you to safely remove this unit and an external media device.

When the external media device is connected to other devices such as Blu-ray disc recorder, a message prompting to format the external media device may display. All the scenes and still pictures recorded on the external media device will be erased if formatted. Do not format as important data will get erased and it will be impossible to restore.

■ Points to check before copying

- When using an external media device for the first time, or using an external media device that has been used with other devices, first run [FORMAT MEDIA].
- Before copying, go to [MEDIA STATUS] to check the amount of free space on the external media device. (→ 140)
- It may take longer to copy when there are many scenes.
- If you copy protected scenes or still pictures, the protection setting of the copied scenes or still pictures are canceled.
- The order in which the scenes were copied cannot be changed.

Before you delete the data on the SD card after copying is complete, be sure to play back the external media device to check that they have been copied to correctly. (→ 142)

■ Formatting

This is for initializing the external media device.

- Please be aware that if a media is formatted then all the data recorded on the media is erased and cannot be recovered. Back up important data on a PC etc.
- Connect this unit to the external media device and touch [Playback from External Media]. Select the menu.

MENU : [OTHER FUNCTION] → [FORMAT MEDIA] → [EXTERNAL]

- When formatting is complete, touch [EXIT] to exit the message screen.
- Connect this unit and the external media device to format.
You may no longer be able to use the external media device if you format them on another device such as a PC etc.
- This unit formats the external media device in exFAT.

■ Displaying media information

The used space of the external media device can be checked.

- Connect this unit to the external media device and touch [Playback from External Media]. Select the menu.

MENU : [OTHER FUNCTION] → [MEDIA STATUS]

- If you touch [CHANGE MEDIA], you can switch the display between the SD card 1, SD card 2, and the external media device.

Copy once

1 Connect this unit to the external media device to prepare for copying. (→ 138)

2 Touch [COPY ONCE].

- You can also access this function by selecting menu items.
[COPY] → [COPY ONCE]

3 Touch the media you want to copy.

4 Touch [YES].

5 Touch [EXIT] when the copy complete message is displayed.

- The thumbnail view of the copy destination is indicated.

When you stop copying halfway:

Touch [CANCEL] while copying.

Copy selected files

1 Connect this unit to the external media device to prepare for copying. (→ 138)

2 Touch [SELECT COPY].

- You can also access this function by selecting menu items.
[COPY] → [SELECT COPY]

3 Touch the media you want to copy.

[1 → ]: When copying from the SD card 1 to the external media device.

[2 → ]: When copying from the SD card 2 to the external media device.

- For information on copying between SD cards, refer to page 125.

4 Touch the desired items following the instructions on the screen.

- It will return to the previous step by touching [Return].
- (When [SELECT SCENES] is selected)
When touched, the scene/still picture is selected and the  indication appears on the thumbnail. Touch the scene/still picture again to cancel the operation.
- (When [SELECT DATE] is selected)
When touched, the date is selected and surrounded by red. Touch the date again to cancel the operation.
- Up to 99 scenes/ 99 dates can be selected continuously.

5 Touch [EXIT] when the copy complete message is displayed.

- The thumbnail view of the copy destination is indicated.

When you stop copying halfway:

Touch [CANCEL] while copying.

Playing back the External Media

- Only motion picture/still picture that have been copied by connecting this unit to the external media device can be played back.

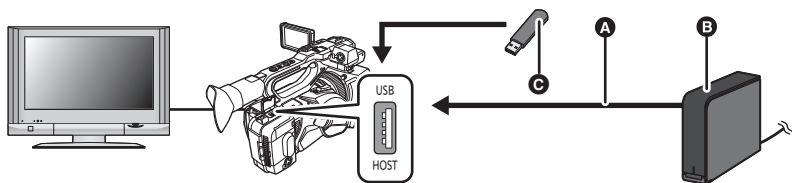

- A** USB Cable (supplied with USB HDD)
- B** USB HDD (commercially-available)
- C** USB flash memory (commercially-available)

1 Connect this unit to the external media device to prepare for playback. (→ 138)

- When playing back on an external monitor, connect this unit to the external monitor. (→ 128)

2 Touch [Playback from External Media].

3 Touch the scene or still picture to be played back and then play it back.



- The playback operation is performed the same as when playing back motion pictures or still pictures. (→ 116, 119)

To terminate the connection between this unit and the external media device

Touch the play mode select icon (→ 115) and then touch .

- Disconnect the USB Cable from this unit.



- It is also possible to switch the media to play back by touching the play mode select icon. When the external media device is connected, the  (external media device) can be selected from the displayed media types. (→ 115)
- In the following cases, when you have touched a play mode select icon and selected the recording format for playback, this unit will be restarted to change the system frequency. After the restart, perform Step 2.
 - When you have switched recording format from [4K/24.00p] to a different option.
 - When you have switched recording format from an option other than [4K/24.00p] to [4K/24.00p]
- Deleting scenes and still pictures on the external media device may take time.
- You cannot set the [SCENE PROTECT] during playback of  (external media device). (→ 124)

Using an iPad as a Remote Control (AG ROP application)

Attaching a wireless module that support this unit (→ 144) to the USB HOST terminal of this unit allows you to connect to a wireless LAN network. You can remotely control some functions by connecting this unit and an iPad on which the AG ROP application is installed.

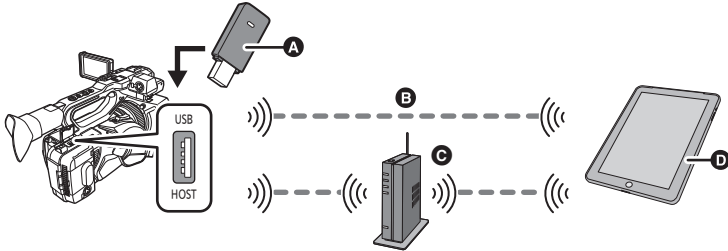

- A** Wireless module that support this unit
- B** Direct connection
- C** Wireless access point connection
- D** iPad and AG ROP application

You can perform the following remote control operations with the AG ROP application:

- Checking the camera status
- Checking the thumbnails of the recorded scenes
- Playing back scenes recorded as sub recordings with [DUAL CODEC REC] set to [FHD 8Mbps]
- Controlling the camera remotely (recording control and Time Code/User Information operations)

-
- For information on how to operate the AG ROP application, refer to its Help.
 - You can store a wireless module in the hand strap.

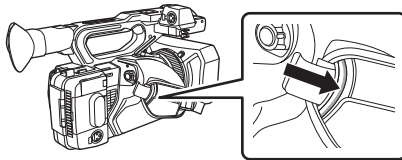

Before connection

iPad/AG ROP application

Install the AG ROP application on the iPad.

- Download the AG ROP application from the App Store.
- Supported OS for the AG ROP application: iOS 7.1 or later (as of November 2016)

Wireless module

Attach a wireless module that support this unit to the USB HOST terminal of this unit.

- For details on wireless modules that support this unit, refer to the support desk at the following website.

<http://pro-av.panasonic.net/>

Settings to be made on this unit

To connect an iPad to this unit via wireless LAN, the following information on this unit is required:

- User account name
- Password
- IP address
- If you set [DHCP] in [Wireless LAN setup] to [SERVER] and connect to a network, you are not required to set the IP address.
- The user account and password can be set in [USER ACCOUNT].
- The IP address can be set in [Wireless LAN setup]. (→ 146)

■ Setting the user account name and password

1 Select the menu.

MENU: [NETWORK SETUP] → [USER ACCOUNT]

2 Touch [SET].

3 Select and touch an item that has not been registered.

4 Touch [Refresh].

• Touch [DELETE] to clear the selected user account.

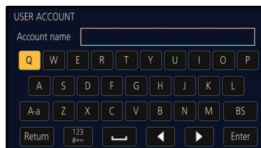

5 Enter a user account name.

- Enter a maximum of 31 characters.
- After entering the title, touch [Enter].



Entering text

Operate in the same way as you enter characters with a keyboard.

Icon	Description of operation
[A-a]	Switches between uppercase and lowercase.
[Return]	Returns to the previous screen. The entered characters are canceled.
[123 #+=]	Switches to symbols and numbers.
[_]	Enters a space.
[BS]	Deletes a character. Deletes the previous character if the cursor is in an empty space.
 / 	Moves the cursor to left or right.
[Enter]	Ends text entry.

6 Enter a password.

- Enter between 6 and 15 characters.
- When the entry is complete, touch [Enter].

7 Re-enter the password.

- When the entry is complete, touch [Enter].

8 Touch [RETURN].

- Touch [EXIT] to exit the menu screen.

-
- The default setting is [OFF] with a user account name of [guest] and a password of [agguest].
 - Apply the set user account name and password to [AG ROP] in [Settings] on the iPad. For details, refer to [CONNECTION] in Help of the AG ROP app.

■ Configuring the wireless LAN settings (IP address, etc.)

1 Select the menu.

MENU : [NETWORK SETUP] → [Wireless LAN setup]

2 Touch and set the desired items as needed.

- All default settings are indicated with underlined text.

[IP Address]:	Enter the IP address. <ul style="list-style-type: none">• The default setting is [192.168.0.1].
[Subnet Mask]:	Enter the subnet mask. <ul style="list-style-type: none">• The default setting is [255.255.255.0].
[Gateway]:	Enter the gateway. <ul style="list-style-type: none">• The default setting is [192.168.0.254].
[DHCP]:	[OFF]: Disables automatic retrieval by DHCP and the DHCP server function.
	[CLIENT]: Performs automatic retrieval by DHCP when connecting with [WIRELESS SETUP] set to [SSID(SELECT)] or [SSID(MANUAL)].
	[SERVER]: Enables the DHCP server function when connecting with [WIRELESS SETUP] set to [DIRECT].
[MAC Address]:	Displays the MAC address.

- If you make a connection with [WIRELESS SETUP] set to [DIRECT], the [Gateway] setting will be disabled.
- [IP Address], [Subnet Mask], and [Gateway] cannot be set when [DHCP] is set to [CLIENT].
- [MAC Address] cannot be changed.
- For details on how to enter characters, refer to page 145.

3 Touch [EXIT].

-
- A connection cannot be made unless the combination of the IP address, subnet mask, and gateway are correct.
 - When not using the gateway, set it to [0.0.0.0].
 - When [DHCP] is set to [OFF] or [CLIENT], apply the [IP Address] setting to [AG ROP] in [Settings] on the iPad. For details, refer to [CONNECTION] in Help of the AG ROP app.

Connecting this unit and an iPad

● Change the mode to Recording Mode. (→ 32)

If you switch to Recording Mode while this unit is connected in Playback Mode, the connection may be terminated to restart this unit. We recommend setting this unit to Recording Mode before making a connection.

■ Settings to be made on the iPad

For information on the settings to be made on the iPad, refer to [CONNECTION] in Help of the AG ROP app.

■ Icons to be displayed during connection

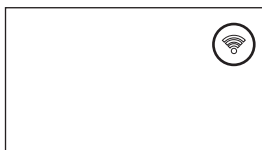

Wireless LAN connection:

connected / not connected

- The display will change as follows according to the radio wave intensity: (Weak) → → (Strong).

AG ROP application connection:

connected

- The display will change as follows according to the radio wave intensity: (Weak) → → (Strong).

Connecting directly

Configure the settings in this section to directly connect this unit and the iPad.

- Attach a wireless module that support this unit to the USB HOST terminal of this unit. (→ 144)
- Set [USB MODE SELECT] to [HOST]. (→ 198)
- Set [USB MODE] to [ON]. (→ 198)

1 Select the menu.

: [NETWORK SETUP] → [WIRELESS SETUP] → [DIRECT]

2 Touch and set the desired items as needed.

- All default settings are indicated with underlined text.

[SSID]:	Enter the network name (SSID) for this unit.
[BAND]:	Select the frequency band to be used. <u>[2.4GHz]</u> / <u>[5GHz]</u>
[CHANNEL (2.4GHz)]:	Sets the channel to be used for 2.4 GHz. <u>[AUTO]</u> / <u>[CH1]</u> / <u>[CH6]</u> / <u>[CH11]</u>
[CHANNEL (5GHz)]:	Sets the channel to be used for 5 GHz. <u>[AUTO]</u> / <u>[CH36]</u> / <u>[CH40]</u> / <u>[CH44]</u> / <u>[CH48]</u> / <u>[CH149]</u> / <u>[CH153]</u> / <u>[CH157]</u> / <u>[CH161]</u> / <u>[CH165]</u>
[Password]:	Sets the password. <ul style="list-style-type: none">● The default setting is [01234567890123456789abcdef].

- When [DIRECT] is selected, [SECURITY TYPE] is fixed to [WPA2-AES].
- Some settings in [BAND], [CHANNEL (2.4GHz)] and [CHANNEL (5GHz)] cannot be selected depending on the wireless module used.
- For details on how to enter characters, refer to page 145.

3 Touch [RETURN].

4 Set [DHCP] to [SERVER].

MENU  : [NETWORK SETUP] → [Wireless LAN setup] → [DHCP] → [SERVER]

5 Touch [EXIT].

6 Select the SSID of this unit from the Wi-Fi® setup of the iPad.

7 Enter the password into the iPad.

8 Check the network connection.

- When this unit is ready to be connected,  will be displayed on its screen.
- To terminate the connection, after terminating the connection on the iPad side, set [USB MODE] to [OFF].

Connecting to a wireless access point

Configure the settings in this section to connect this unit and an iPad using a wireless access point.

■ Searching for wireless access points to set up a connection

- Attach a wireless module that support this unit to the USB HOST terminal of this unit. (→ 144)
- Set [USB MODE SELECT] to [HOST]. (→ 198)
- Set [USB MODE] to [ON]. (→ 198)

1 Select the menu.

MENU  : [NETWORK SETUP] → [WIRELESS SETUP] → [SSID(SELECT)]

2 Touch the wireless access point to connect to.

- The SSIDs of wireless access points found with the search will be displayed.
- If you touch [Refresh], you can search for wireless access points again.

3 Touch [ENTER].

- If an encryption key (password) is not set, the setup is complete.

4 (If an encryption key (password) is set)

Enter the password.

- For details on how to enter characters, refer to page 145.
- When the connection is complete, touch [Enter].

5 Check the network connection.

- When the connection is complete,  is displayed on the screen of this unit.
- To terminate the connection, after terminating the connection on the iPad side, set [USB MODE] to [OFF].

- [SSID(SELECT)] is available only when [USB MODE] is set to [ON], [USB MODE SELECT] is set to [HOST] and a wireless module that supports this unit is attached.
- Depending on your environment, the communication speed may become slower or the wireless access point may not be available for use.
- When [DHCP] in [Wireless LAN setup] is set to [OFF] or [CLIENT], apply the [IP Address] setting to [AG ROP] in [Settings] (→ 146) on the iPad. For details, refer to [CONNECTION] in Help of the AG ROP app.

■ Setting up a connection manually

- Attach a wireless module that support this unit to the USB HOST terminal of this unit. (→ 144)
- Set [USB MODE SELECT] to [HOST]. (→ 198)
- Set [USB MODE] to [ON]. (→ 198)

1 Select the menu.

 : [NETWORK SETUP] → [WIRELESS SETUP] → [SSID(MANUAL)]

2 Touch and set the desired items as needed.

- All default settings are indicated with underlined text.

[SSID]:	Enter the SSID for the wireless access point to connect to. <ul style="list-style-type: none"> • This item is not set by default.
[SECURITY TYPE]:	Set the network authentication and encryption types. <u>[WPA2-AES]</u> / <u>[WPA-AES]</u> / <u>[WPA2-TKIP]</u> / <u>[WPA-TKIP]</u> / <u>[NONE]</u>
[Password]:	Enter the password for the wireless access point to be connected. <ul style="list-style-type: none"> • This item is not set by default. • This item is not available when [SECURITY TYPE] is set to [NONE].

- When [SSID(MANUAL)] is selected, [BAND] is fixed to [2.4GHz], and [CHANNEL (2.4GHz)] and [CHANNEL (5GHz)] are fixed to [AUTO].
- For details on how to enter characters, refer to page 145.

3 Touch [EXIT].

4 Check the network connection.

- When the connection is complete,  is displayed on the screen of this unit.
- To terminate the connection, after terminating the connection on the iPad side, set [USB MODE] to [OFF].

-
- Depending on your environment, the communication speed may become slower or the wireless access point may not be available for use.
 - When [DHCP] in [Wireless LAN setup] is set to [OFF] or [CLIENT], apply the [IP Address] setting to [AG ROP] in [Settings] (→ 146) on the iPad. For details, refer to [CONNECTION] in Help of the AG ROP app.

■ Connecting from History

Connections made to wireless access points are saved in History. Connecting from History allows you to easily connect with the same settings as used previously.

- Attach a wireless module that support this unit to the USB HOST terminal of this unit. (→ 144)
- Set [USB MODE SELECT] to [HOST]. (→ 198)
- Set [USB MODE] to [ON]. (→ 198)

1 Select the menu.

 : [NETWORK SETUP] → [CONNECTION HISTORY]

2 Touch the item you want to connect to.

- Connection records in History will be displayed as SSIDs of wireless access points.
- Touch [DELETE] to clear the selected history data.

3 Touch [EXIT].

4 Check the network connection.

- When the connection is complete,  is displayed on the screen of this unit.
 - To terminate the connection, after terminating the AG ROP application connection, set [USB MODE] to [OFF].
-
- Up to 20 most recently used connections can be stored in History.
 - [CONNECTION HISTORY] is available only when [USB MODE] is set to [ON], [USB MODE SELECT] is set to [HOST] and a wireless module that supports this unit is attached.

Operations during AG ROP application connection

■ Operations with this unit during connection

- The following buttons are disabled:
 - SHUTTER button
 - GAIN button
 - WHITE BAL button
 - MENU button (The applicable USER button is also disabled, making it impossible to operate the menu.)
 - BARS button
 - THUMBNAIL button
- You can change the [ZOOM/FOCUS] setting in the [SW SETUP] menu to switch between operating this unit and operating it with the AG ROP application. Since selecting [IP REMOTE] will disable the following switches and buttons, to operate them with this unit, select [CAMERA]:
 - Focus ring
 - Zoom lever
 - Sub zoom lever
 - PUSH AUTO button, USER button to which [PUSH AUTO] is registered.
 - FOCUS A/M/ ∞ switch
 - Switching to Auto Focus Mode with the AUTO/MANU switch (→ 45)
- You can press the IRIS button to switch between operating the iris ring of this unit and operating it with the AG ROP application. The iris ring of this unit cannot be used when you operate this unit with the AG ROP application.

■ Recording and playback operations during connection

You can perform operations with either this unit or the AG ROP application while connected to the AG ROP application.

■ Limitations on this unit during connection

- The following functions are disabled during AG ROP application connection:
 - Magnifying the Focus Assist display (→ 57)
 - Focus Transition (→ 62)
 - USB Mode (USER button) (→ 87)
 - Area Mode (→ 92)
-
- Settings that are changed remotely with the AG ROP application are applied to the corresponding settings of this unit.
 - When **WARNING** is flashing on the AG ROP application screen, remote control operations may not be performed due to an error on this unit. Check this unit. For details, refer to “Warning Indications” on page 213.

Using the Menu

Refer to page 41 for how to set up the Menu.

Scene file



Settings that are assigned to [F1:] in [FILE SELECT] by default are indicated with underlined text.



[FILE SELECT]

You can save the desired image settings to each scene number. Switch the scene number in accordance with the recording conditions.

[F1:]/[F2:FLUO]/[F3:SPARK]/[F4:STILL]/[F5:CINE V]/[F6:CINE D]

1 Touch [FILE SELECT].

2 Touch / to select the scene number.

• Touch [EXIT] to exit the menu screen.

3 (To change the image settings)

Change the setting of [SCENE FILE] menu.

• You can save the settings of the following menu items to the scene number you have selected.
(→ 153 to 160)

- [SYNCHRO SCAN]
- [MASTER DETAIL]
- [DETAIL CORING]
- [SKIN TONE DTL]
- [V DETAIL LEVEL]
- [RB GAIN CONTROL SETTING]
- [CHROMA LEVEL]
- [CHROMA PHASE]
- [MATRIX]
- [COLOR CORRECTION SETTING]
- [MASTER PED]
- [GAMMA MODE]
- [BLACK GAMMA]
- [KNEE MODE]
- [KNEE MASTER POINT]
- [KNEE MASTER SLOPE]
- [DRS]
- [DRS EFFECT]
- [AUTO IRIS LEVEL]
- [AUTO IRIS LEVEL EFFECT]
- [NR CONTROL]

Default scene number settings

[F1:]	Setting appropriate for standard recording
[F2:FLUO]	Setting appropriate for recording considering the characteristic of fluorescent lamps (indoors, etc.)
[F3:SPARK]	Setting appropriate for recording with modulation in resolution, color shade, and contrast
[F4:STILL]	Setting which allows you to use a scene file with a picture tone similar to that produced with a digital still camera.
[F5:CINE V]	Setting appropriate for recording as a cinema with high contrast
[F6:CINE D]	Setting appropriate for recording as a cinema with high dynamic range

- This function's default setting is [F1:].
- It is possible to switch the scene number by touching **F1:** to **F6:** while displaying the operation icons. (→ 111)
- You can rename the titles for scene numbers (FLUO, etc.) in [NAME EDIT].
- It will return to the default settings when [SCENE] is selected in [INITIAL SET]. (→ 199)

[NAME EDIT]

You can rename the title of the scene number selected in [FILE SELECT].

1 Touch [NAME EDIT].

2 Enter the desired title.

- For information on how to enter characters, refer to page 145.
- Up to 6 alphanumeric characters can be entered.
- Touch [Return] to return to the previous screen. (The title will not be renamed to the one that has been entered.)

3 Touch [Enter].

- The title will be updated.

[LOAD/SAVE]

You can save the scene file settings to the SD card or load them from the SD card to this unit. (→ 100)

[LOAD]/[SAVE]

[SYNCHRO SCAN]

Sets the initial Synchro Scan setting.

- Depending on the size and frame rate in [REC FORMAT], the setting range varies. (→ 162)

1 Touch [SYNCHRO SCAN].

2 Touch / to adjust settings.

3 Touch [EXIT] to complete the setting.

■ Note on the [SYNCHRO SCAN] setting



A separate [SYNCHRO SCAN] setting is maintained for each size and frame rate in [REC FORMAT].

- Default settings are indicated with underlined text.

Frame rates	[SYNCHRO SCAN] setting
59.94p/59.94i	1/60.0 to 1/249.7
29.97p	1/30.0 to 1/60.0 to 1/249.7
23.98p	1/24.0 to 1/48.0 to 1/249.6
24.00p	1/24.0 to 1/48.0 to 1/249.9
50.00p/50.00i	<u>1/50.0</u> to 1/250.0
25.00p	1/25.0 to 1/50.0 to 1/250.0

[MASTER DETAIL]



Adjusts the degree of overall outline correction in images.

- 1 Touch [MASTER DETAIL].
- 2 Touch  /  to adjust settings.
 - You can select a value between -31 and +31.
- 3 Touch [EXIT] to exit the menu screen.

-
- The default setting that is assigned to [F1:] in [FILE SELECT] is "0".

[DETAIL CORING]

Adjusts the detail noise removal level.

- 1 Touch [DETAIL CORING].
- 2 Touch  /  to adjust settings.
 - You can select a value between 0 and 60.
- 3 Touch [EXIT] to exit the menu screen.

-
- The default setting that is assigned to [F1:] in [FILE SELECT] is "1".

[SKIN TONE DTL]

This makes skin colors appear softer for a more attractive appearance.

This is more effective if you record a person closely from the torso up.



[ON]/[OFF]

- 1 Touch [SKIN TONE DTL].
- 2 Touch [ON].
- 3 Touch [EXIT] to exit the menu screen.

-
- If the background or anything else in the scene has colors similar to the skin color, they will also be smoothed.
 - If the brightness is insufficient, the effect may not be clear.
 - If you record a person in the distance, the face may not be recorded clearly. In this case, set [SKIN TONE DTL] to [OFF] or zoom in on the face (close-up) to record.

[V DETAIL LEVEL]

Adjusts the degree of vertical outline correction in images.

- 1 Touch [V DETAIL LEVEL].
- 2 Touch  /  to adjust settings.
 - You can select a value between -7 and +7.
- 3 Touch [EXIT] to exit the menu screen.

-
- The default setting that is assigned to [F1:] in [FILE SELECT] is "0".

[RB GAIN CONTROL SETTING]

This adjusts the color balance for [Ach] or [Bch] of the White Balance mode. You can also set whether or not to apply the color balance settings to Auto White Balance/Auto Black Balance.

1 Touch [RB GAIN CONTROL SETTING], and select the desired item.

[AWB A]: Setting for the White Balance mode [Ach]

[AWB B]: Setting for the White Balance mode [Bch]

2 Touch the desired setting item.

[R GAIN]: Adjusts the intensity of red.

[B GAIN]: Adjusts the intensity of blue.

[GAIN OFFSET]: Sets whether to maintain or reset the [R GAIN] and [B GAIN] settings when Auto White Balance/Auto Black Balance is used.

3 (If you have touched [R GAIN]/[B GAIN] in Step 2)

Touch  /  to adjust the color balance.

- You can select a value between -30 and +30.

- Touch [RETURN].

(If you have touched [GAIN OFFSET] in Step 2)

Touch [ON] or [OFF].

[ON]: Maintains the [R GAIN] and [B GAIN] settings when Auto White Balance/Auto Black Balance is used.

[OFF]: Resets the [R GAIN] and [B GAIN] settings when Auto White Balance/Auto Black Balance is used.

- To make additional changes, repeat Steps 2-3.

4 Touch [EXIT] to exit the menu screen.

-
- The default settings that are assigned to [F1:] in [FILE SELECT] are as follows:



- [R GAIN]: "0"

- [B GAIN]: "0"

- [GAIN OFFSET]: [OFF]

[CHROMA LEVEL]



Adjusts color density.

- 1 Touch **[CHROMA LEVEL]**.
- 2 Touch  /  to adjust settings.
 - You can select a value between -70 and +30.
- 3 Touch **[EXIT]** to exit the menu screen.

-
- The default setting that is assigned to [F1:] in [FILE SELECT] is "0".

[CHROMA PHASE]



Adjusts color balance.

- 1 Touch **[CHROMA PHASE]**.
- 2 Touch  /  to adjust settings.
 - You can select a value between -31 and +31.
- 3 Touch **[EXIT]** to exit the menu screen.

-
- The default setting that is assigned to [F1:] in [FILE SELECT] is "0".

[MATRIX]

Represents the color during the recording.

- 1 Touch **[MATRIX]**.
- 2 Touch  /  to select the setting item.

[NORM1]:	Suitable for recording in the open air or under a halogen lamp.
[NORM2]:	Suitable for brighter colors than the [NORM1] mode.
[FLUO]:	Suitable for recording indoors under fluorescent lamp.
[CINE-LIKE]:	Suitable for cinema-like image.
[STILL-LIKE]:	Expresses colors in a picture tone similar to that produced with a digital still camera.

- 3 Touch **[EXIT]** to exit the menu screen.

[COLOR CORRECTION SETTING]

This function sets color saturation and phase. It applies individual effect on 16 phases in an image. It can be set to individual color hue.

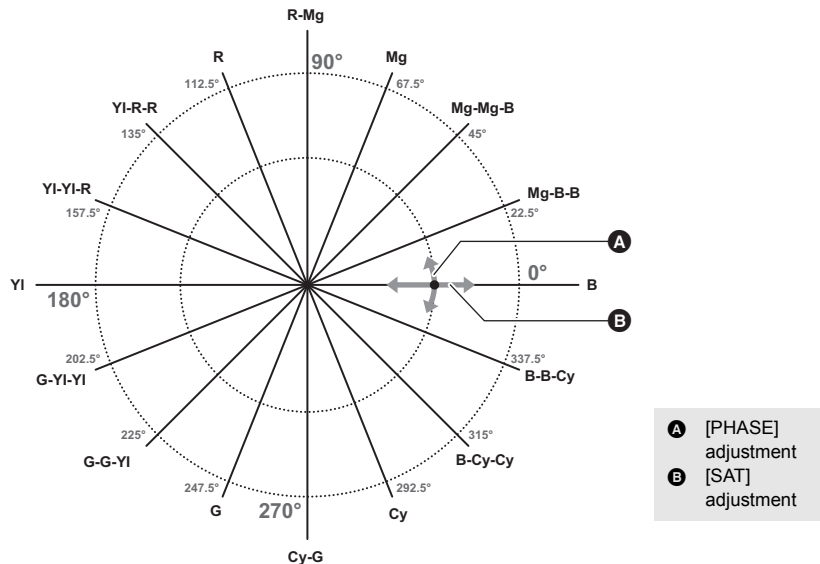

- 1 Touch [COLOR CORRECTION SETTING].
- 2 Touch the phase you want to set.

[R]/[R-Mg]/[Mg]/[Mg-Mg-B]/[Mg-B-B]/[B]/[B-B-Cy]/[B-Cy-Cy]/[Cy]/[Cy-G]/[G]/[G-G-Yl]/
[G-Yl-Yl]/[Yl]/[Yl-Yl-R]/[Yl-R-R]

- Next (Previous) page can be displayed by touching / .

- 3 (To adjust the saturation)

Touch [SAT].

(To adjust the phase)

Touch [PHASE].

- 4 Touch / to adjust settings.

- You can select a value between -63 and +63.
- (If you have touched [PHASE])

Making adjustments in the + direction corresponds to making adjustments clockwise in the diagram above. Conversely, making adjustments in the - direction corresponds to making adjustments counterclockwise in the diagram.



- 5 Touch [RETURN].

- Touch [EXIT] to exit the menu screen.

-
- By default the following values are set for [F1:] in [FILE SELECT]
 - SAT: “0”
 - PHASE: “0”

[MASTER PED]



Adjustment of black level based on the image is performed.

- 1 Touch [MASTER PED].
 - 2 Touch  /  to adjust the black level.
- You can select a value between –150 and +150.
- 3 Touch [EXIT] to exit the menu screen.

-
- The default setting that is assigned to [F1:] in [FILE SELECT] is “0”.

[GAMMA MODE]

Tone or contrast of the image is set in accordance with the recorded scenes.

- 1 Touch [GAMMA MODE].
- 2 Touch  /  to select the setting item.



[HD]:	This is the video gamma feature for HD (High Definition).
[SD]:	This increases gain in darker areas more than [HD] does.
[FILMLIKE1]:	This feature reproduces highlight areas more than [HD] does.
[FILMLIKE2]:	This feature reproduces highlight areas more than [FILMLIKE1] does.
[FILMLIKE3]:	This feature reproduces highlight areas more than [FILMLIKE2] does.
[CINE-LIKE V]:	This gamma feature creates cinematic images with sharper contrast.
[CINE-LIKE D]:	This gamma feature creates cinematic images.
[STILL-LIKE]:	Expresses colors in a picture tone similar to that produced with a digital still camera.

- 3 Touch [EXIT] to exit the menu screen.

-
- When [CINE-LIKE V] or [CINE-LIKE D] is selected, we recommend that you set the lens aperture to a level lower than the normal lens iris level (approximately 1/2) to fully utilize the feature of the selected setting.

[BLACK GAMMA]



This sets the gamma curve of dark areas.

- 1 Touch [BLACK GAMMA].
 - 2 Touch  /  to adjust settings.
- You can select a value between –8 and +8.
 - Making adjustments in the – direction compresses dark areas, while making adjustments in the + direction expands them.
- 3 Touch [EXIT] to complete the setting.

-
- The default setting that is assigned to [F1:] in [FILE SELECT] is “0”.

[KNEE MODE]

To avoid overexposure, select the compression level of the high intensity video signals received through the image sensor.



- 1 Touch **[KNEE MODE]**.
- 2 Touch  /  to select the setting item.

[AUTO]:	Sets the level automatically according to the signals received.
[MANUAL]:	Applies the [KNEE MASTER POINT] and [KNEE MASTER SLOPE] settings.
[OFF]:	Disables the Knee function.

- 3 Touch **[EXIT]** to exit the menu screen.

[KNEE MASTER POINT]



This adjusts the knee point position in 0.5% steps when [KNEE MODE] is set to [MANUAL].

- 1 Touch **[KNEE MASTER POINT]**.
- 2 Touch  /  to adjust settings.
 - You can select a value between 80.0 and 107.0.
- 3 Touch **[EXIT]** to exit the menu screen.

- The default setting that is assigned to [F1:] in [FILE SELECT] is "93.0".

[KNEE MASTER SLOPE]

This sets the knee inclination when [KNEE MODE] is set to [MANUAL].

- 1 Touch **[KNEE MASTER SLOPE]**.
- 2 Touch  /  to adjust settings.
 - You can select a value between 0 and 99.
- 3 Touch **[EXIT]** to exit the menu screen.

- The default setting that is assigned to [F1:] in [FILE SELECT] is "85".

[DRS]

Selects the DRS (Dynamic Range Stretcher) function. (→ 91)

[ON]/[OFF]

[DRS EFFECT]

Selects the level of the DRS function.

- 1 Touch **[DRS EFFECT]**.
- 2 Touch  /  to select the setting item.

[1]/[2]/[3]

- Higher the value, greater the compression level of the highly illuminated area.
- Higher the value, greater the noise of the dark area.

- 3 Touch **[EXIT]** to exit the menu screen.

• This item is not available in the following cases:

- During Super Slow Recording (→ 105)
- In Variable Frame Rate Mode (→ 102)



[AUTO IRIS LEVEL]

This enables/disables Auto Iris Level. (→ 69)

[ON]/[OFF]

[AUTO IRIS LEVEL EFFECT]

Adjusting brightness during the Auto Iris Mode. (→ 69)

- 1 Touch **[AUTO IRIS LEVEL EFFECT]**.
- 2 Touch  /  to adjust settings.

- You can select a value between -50 and +50.
- 3 Touch **[EXIT]** to exit the menu screen.

• The default setting that is assigned to [F1:] in [FILE SELECT] is "0".

[NR CONTROL]

You can control the noise reduction effect and afterimage intensity by adjusting the noise reduction setting.

- 1 Touch **[NR CONTROL]**.
- 2 Touch  /  to adjust settings.

- You can select a value between -7 and +7.
- Adjusting the setting in the minus (-) direction weakens the noise reduction effect, thereby reducing afterimages. Note that this also tends to increase noise.
- Adjusting the setting in the plus (+) direction enhances the noise reduction effect, thereby reducing noise. Note that this may also cause afterimages to appear more frequently.

- 3 Touch **[EXIT]** to exit the menu screen.

• The default setting that is assigned to [F1:] in [FILE SELECT] is "0".

System mode



All default settings are indicated with underlined text.

 : [SYSTEM MODE] → desired setting

[SYSTEM FREQ]

Set the system frequency of this unit.

[59.94Hz]:	System frequency for regions where the TV broadcasting system is NTSC
[50.00Hz]:	System frequency for regions where the TV broadcasting system is PAL

- After you have changed the system frequency, this unit will be restarted automatically.
- By default, the system frequency is set to the broadcasting system of the region where this product was purchased.
- When recording with [REC MODE] set to [AVCHD], you cannot record scenes of different system frequencies into a single SD card. Use a different SD card for each system frequency.

[REC MODE]

Switch the recording mode of the motion pictures to record.

[MOV]*:	This recording method is suitable for editing images. Motion pictures will be saved in MOV format.
[MP4]*:	This recording method is suitable for editing images. Motion pictures will be saved in MP4 format.
[AVCHD]:	This recording method is suitable for playback on a high-definition compatible external monitor.

* It is not compatible with motion pictures recorded in AVCHD.

- This item cannot be set during Freeze Frame (→ 91)

[REC FORMAT]

Switch the picture quality of motion pictures to be recorded with this unit.

Depending on the settings of [SYSTEM FREQ] (→ 161) and [REC MODE], the available [REC FORMAT] settings differ.

How to read a [REC FORMAT] setting

Items that make up a [REC FORMAT] setting represent Size, Vertical resolution, Frame rate, and Bit rate. (Excluding the [REC FORMAT] settings that are available when [REC MODE] is set to [AVCHD])

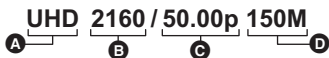

- | | |
|------------------------------|---------------------|
| A Size | C Frame rate |
| B Vertical resolution | D Bit rate |

- Smoother motion picture can be recorded with the higher value for the frame rate. [i] and [p] of the frame rate means interlace and progressive respectively.

Interlace (interlacing scanning)

Video signal that divides the effective scanning lines to half and send them alternatively

Progressive (progressive scanning)

High density video signal sending the effective scanning lines simultaneously (It will be higher quality image than the interlace.)

- The higher the bit rate value is, the higher the picture quality becomes, except for when the recording format is $\frac{ALL-I}{200M}$ (This exception is due to a difference in compression method).
- It can record with highest quality image in this unit when set to [UHD 2160/59.94p 150M] or [UHD 2160/50.00p 150M].
- When the recording format is $\frac{ALL-I}{200M}$, recording is performed with ALL-Intra. ALL-Intra is a compression method that compresses each frame. This method results in larger file sizes, but it can minimize the deterioration in picture quality that occurs during editing.
- Depending on the [REC MODE] setting and the bit rate of the [REC FORMAT] setting, its required Speed Class of the SD card differs. Use an SD card that meets the settings. For details, refer to “About the Speed Class ratings for recording motion pictures” on page 30.

• When [MOV] or [MP4] in [REC MODE] is selected

Recording format	System frequency setting	Size (Picture size)	Frame rate	Bit rate (VBR)		
[4K 2160/24.00p 100M]	[59.94Hz]/ [50.00Hz]	4K (4096×2160)	24.00p	Average 100 Mbps		
[UHD 2160/59.94p 150M]	[59.94Hz]	UHD (3840×2160)	59.94p	Average 150 Mbps		
[UHD 2160/29.97p 100M]			29.97p	Average 100 Mbps		
[UHD 2160/23.98p 100M]			23.98p			
[FHD 1080/59.94p ^{ALL-I} 200M]		FHD (1920×1080)	59.94p	Average 200 Mbps		
[FHD 1080/59.94p 100M]				Average 100 Mbps		
[FHD 1080/59.94p 50M]				Average 50 Mbps		
[FHD 1080/29.97p ^{ALL-I} 200M]			29.97p	Average 200 Mbps		
[FHD 1080/23.98p ^{ALL-I} 200M]			23.98p			
[FHD 1080/29.97p 50M]			29.97p	Average 50 Mbps		
[FHD 1080/23.98p 50M]			23.98p			
[FHD 1080/59.94i 50M]			59.94i			
[UHD 2160/50.00p 150M]			[50.00Hz]	UHD (3840×2160)	50.00p	Average 150 Mbps
[UHD 2160/25.00p 100M]					25.00p	Average 100 Mbps
[FHD 1080/50.00p ^{ALL-I} 200M]		FHD (1920×1080)		50.00p	Average 200 Mbps	
[FHD 1080/50.00p 100M]	Average 100 Mbps					
[FHD 1080/50.00p 50M]	Average 50 Mbps					
[FHD 1080/25.00p ^{ALL-I} 200M]	25.00p			Average 200 Mbps		
[FHD 1080/25.00p 50M]	50.00i			Average 50 Mbps		
[FHD 1080/50.00i 50M]						

• When [AVCHD] in [REC MODE] is selected

Recording format	System frequency setting	Picture size	Frame rate	Bit rate (VBR)
[PS 1080/59.94p]	[59.94Hz]	1920×1080	59.94p	Average 25 Mbps
[PH 1080/59.94i]			59.94i	Average 21 Mbps
[PH 1080/23.98p]			23.98p	
[HA 1080/59.94i]		1440×1080	59.94i	Average 17 Mbps
[HE 1080/59.94i]			Average 5 Mbps	
[PM 720/59.94p]		1280×720	59.94p	Average 8 Mbps
[SA 480/59.94i]		720×480	59.94i	Average 9 Mbps

Recording format	System frequency setting	Picture size	Frame rate	Bit rate (VBR)
[PS 1080/50.00p]	[50.00Hz]	1920×1080	50.00p	Average 25 Mbps
[PH 1080/50.00i]			50.00i	Average 21 Mbps
[HA 1080/50.00i]		1440×1080		Average 17 Mbps
[HE 1080/50.00i]			Average 5 Mbps	
[PM 720/50.00p]		1280×720	50.00p	Average 8 Mbps
[SA 576/50.00i]		720×576	50.00i	Average 9 Mbps

• Recordable time using the battery (→ 27)

- The system frequency is set to 24.00 Hz when [REC FORMAT] is set to a setting with a frame rate of 24.00p.
- The default setting for [REC MODE] is [MP4], and the default setting for [REC FORMAT] is [UHD 2160/50.00p 150M].
- This item cannot be set during Freeze Frame (→ 91)
- Please refer to page 224 about approximate recordable time.
- When any of the following [REC FORMAT] settings is selected, the angle of view will change.
 - [4K 2160/24.00p 100M]
- When the unit is moved a lot or moved quickly, or when a fast-moving subject is recorded, mosaic-type noise may appear at playback. (Only when recording AVCHD scenes)
- In the following cases, this unit will be restarted to switch the system frequency:
 - When you change the [REC FORMAT] setting from a setting with a frame rate of 24.00p to a setting with a different frame rate
 - When you change the [REC FORMAT] setting from a setting with a frame rate other than 24.00p to a setting with a frame rate of 24.00p

About recording formats and recording functions

The relationship between recording formats and recording functions of this unit are shown below.

- “○”: Available; “—”: Not available*

* “Not available” includes instances where the desired function cannot be used or selected.

Recording format	Recording function					
	Normal recording	Interval Rec (→ 183)	Super Slow Recording (→ 105, 184), VFR Mode (→ 102, 184)	Relay recording (→ 178), Simultaneous recording (→ 178)	Background recording (→ 178)	Dual codec recording (→ 178)
[4K 2160/24.00p 100M]	○	○	—	○	—	—
[UHD 2160/59.94p 150M]	○	—	—	○	—	—
[UHD 2160/50.00p 150M]	○	—	—	○	—	—
[UHD 2160/29.97p 100M]	○	○	—	○	—	○

Recording format	Recording function					
	Normal recording	Interval Rec (→ 183)	Super Slow Recording (→ 105, 184), VFR Mode (→ 102, 184)	Relay recording (→ 178), Simultaneous recording (→ 178)	Background recording (→ 178)	Dual codec recording (→ 178)
[UHD 2160/25.00p 100M]	○	○	—	○	—	○
[UHD 2160/23.98p 100M]	○	—	—	○	—	○
[FHD 1080/59.94p <small>ALL-I 200M</small>]	○	—	—	○	—	○
[FHD 1080/50.00p <small>ALL-I 200M</small>]	○	—	—	○	—	○
[FHD 1080/29.97p <small>ALL-I 200M</small>]	○	—	—	○	—	○
[FHD 1080/25.00p <small>ALL-I 200M</small>]	○	—	—	○	—	○
[FHD 1080/23.98p <small>ALL-I 200M</small>]	○	—	—	○	—	○
[FHD 1080/59.94p 100M]	○	—	—	○	—	○
[FHD 1080/50.00p 100M]	○	—	—	○	—	○
[FHD 1080/59.94p 50M]	○	—	—	○	○	—
[FHD 1080/50.00p 50M]	○	—	—	○	○	—
[FHD 1080/29.97p 50M]	○	○	○	○	○	—
[FHD 1080/25.00p 50M]	○	○	○	○	○	—
[FHD 1080/23.98p 50M]	○	—	○	○	○	—
[FHD 1080/59.94i 50M]	○	—	—	○	○	—
[FHD 1080/50.00i 50M]	○	—	—	○	○	—
[PS 1080/59.94p]	○	—	—	○	○	—
[PS 1080/50.00p]	○	—	—	○	○	—
[PH 1080/59.94i]	○	—	—	○	○	—
[PH 1080/50.00i]	○	—	—	○	○	—

Recording format	Recording function					
	Normal recording	Interval Rec (→ 183)	Super Slow Recording (→ 105, 184), VFR Mode (→ 102, 184)	Relay recording (→ 178), Simultaneous recording (→ 178)	Background recording (→ 178)	Dual codec recording (→ 178)
[PH 1080/23.98p]	○	—	—	○	○	—
[HA 1080/59.94i]	○	○	—	○	○	—
[HA 1080/50.00i]	○	○	—	○	○	—
[HE 1080/59.94i]	○	—	—	○	○	—
[HE 1080/50.00i]	○	—	—	○	○	—
[PM 720/59.94p]	○	—	—	○	○	—
[PM 720/50.00p]	○	—	—	○	○	—
[SA 480/59.94i]	○	—	—	○	○	—
[SA 576/50.00i]	○	—	—	○	○	—

[ASPECT CONVERT]

This sets the aspect ratio of images to be recorded with a [REC FORMAT] setting of [SA 480/59.94i] or [SA 576/50.00i].

- Set [REC FORMAT] to [SA 480/59.94i] or [SA 576/50.00i]. (→ 162)

[SIDE CROP]: Records images in standard 4:3 mode. The sides will be cut off.

[SQUEEZE]: Records images by compressing images in the horizontal direction. When recorded images are played back on a wide-screen external monitor, they appear in the 16:9 aspect ratio.

- This function is not available in the following cases:
 - When [REC FORMAT] is set to an option other than [SA 480/59.94i] or [SA 576/50.00i] (→ 162)
 - During Freeze Frame (→ 91)

[EXTENDED SENSITIVITY]

Setting this item to [ON] allows you to set a negative gain value. (→ 70)

- Set [HIGH SENS. MODE] is to [NORMAL]. (→ 167)

[ON]/[OFF]

- When this item is set to [ON], [EX.SENS.] is displayed on the screen.

[HIGH SENS. MODE]

This sets the optimal recording mode for the recording environment.

[NORMAL]: Select this setting when the light level of the recording environment is normal.

[HIGH SENS.]: Select this setting when recording in a dark environment.

- [H.SENS] is displayed on the screen when [HIGH SENS.] is selected.
- This function is not available in the following cases:
 - During Super Slow Recording (→ 105)
 - In Variable Frame Rate Mode (→ 102)
 - During Freeze Frame (→ 91)
- [EXTENDED SENSITIVITY] will be set to [OFF] when [HIGH SENS.] is selected.

[FLASH BAND COMPENSATION]

If you set this item to [ON], you can compensate for and reduce flash band, a phenomenon that creates markedly different levels of luminance between the top and bottom of the image when recording is performed in an environment where another camera is firing its flash. (→ 96)

[ON]/[OFF]

[CAMERA NUMBER SET]

This sets the camera number for this unit.

- 1 Touch **[CAMERA NUMBER SET]**.
- 2 Touch **▲/▼** to change the Camera Number.
 - Numbers between 0 and 16 can be set.
- 3 Touch **[RETURN]**.
 - Touch [EXIT] to exit the menu screen.

- This function's default setting is "0".

User switch

All default settings are indicated with underlined text.

 : [USER SW] → **desired setting**

**[USER1]/[USER2]/[USER3]/[USER4]/
[USER5]/[USER6]/[USER7]/[USER8]/[USER9]**



Sets the function to assign to the USER buttons. (→ 84)

- For the functions of the USER button that can be registered, refer to page 86.

- The default settings are as follows:

- | | |
|------------------------|---------------------------|
| – USER1: [AREA] | – USER6: [O.I.S.] |
| – USER2: [FOCUS MACRO] | – USER7: [LCD/EVF OUTPUT] |
| – USER3: [SLOT SEL] | – USER8: [REC CHECK] |
| – USER4: [WFM] | – USER9: [AWB] |
| – USER5: [ZEBRA] | |

[USER10]/[USER11]/[USER12]/[USER13]



Register functions to USER button icons. (→ 84)

- For the functions of the USER button that can be registered, refer to page 86.

- The default settings are as follows:

- | | |
|-----------------------|----------------------|
| – USER10: [IR REC] | – USER12: [ATW LOCK] |
| – USER11: [BACKLIGHT] | – USER13: [MENU] |

[USER BUTTON DISPLAY]



Switches the display of the set USER button icons. (→ 85)

[ON]/[OFF]

Switch setting



All default settings are indicated with underlined text.

MENU : [SW SETUP] → desired setting

[IRIS RING]

Sets the rotation direction and iris control of the iris ring.

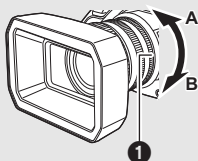

[DOWN OPEN]: Iris will open when it is turned toward B.

[UP OPEN]: Iris will open when it is turned toward A.

1 Iris ring

[LOW GAIN]

Sets the gain value to be used when you switch to [LOW GAIN] by pressing the GAIN button.

1 Touch **[LOW GAIN]**.

2 Touch **▲/▼** to adjust settings.

• You can select [AUTO] or a value between 0 dB and 24 dB.

When [EXTENDED SENSITIVITY] is set to [ON], you can set a value between -3 dB and 24 dB.

(→ 166)

3 Touch **[EXIT]** to exit the menu screen.

• This function's default setting is "0 dB".

• When a negative gain value (a value between -3 dB and -1 dB) is selected, if you set [EXTENDED SENSITIVITY] to [OFF] and operate the GAIN button, the gain value will be set to 0 dB. However, the [LOW GAIN] setting will be maintained.

[MID GAIN]

Sets the gain value to be used when you switch to [MID GAIN] by pressing the GAIN button.

1 Touch **[MID GAIN]**.

2 Touch **▲/▼** to adjust settings.

• You can select [AUTO] or a value between 0 dB and 24 dB.

When [EXTENDED SENSITIVITY] is set to [ON], you can set a value between -3 dB and 24 dB.

(→ 166)

3 Touch **[EXIT]** to exit the menu screen.

• This function's default setting is "6 dB".

• When a negative gain value (a value between -3 dB and -1 dB) is selected, if you set [EXTENDED SENSITIVITY] to [OFF] and operate the GAIN button, the gain value will be set to 0 dB. However, the [MID GAIN] setting will be maintained.

[HIGH GAIN]

Sets the gain value to be used when you switch to [HIGH GAIN] by pressing the GAIN button.

1 Touch [HIGH GAIN].

2 Touch / to adjust settings.

- You can select [AUTO] or a value between 0 dB and 24 dB.

When [EXTENDED SENSITIVITY] is set to [ON], you can set a value between -3 dB and 24 dB.

(→ 166)

3 Touch [EXIT] to exit the menu screen.

- This function's default setting is "12 dB".
- When a negative gain value (a value between -3 dB and -1 dB) is selected, if you set [EXTENDED SENSITIVITY] to [OFF] and operate the GAIN button, the gain value will be set to 0 dB. However, the [HIGH GAIN] setting will be maintained.

[SUPER GAIN]

Sets the gain value for the USER button function [SUPER GAIN]. (→ 71)

[30 dB]/[36 dB]

[O.I.S.]

This enables/disables the Image Stabilizer. (→ 51)

[ON]/[OFF]

[HYBRID O.I.S.]

You can set the Hybrid Optical Image Stabilizer. (→ 51)

[ON]/[OFF]

[CUSTOM O.I.S.]

When [ON] is selected, the Image Stabilizer works with customized [BLUR AMPLITUDE] and [BLUR FREQUENCY] settings. (→ 51)

[ON]/[OFF]

[BLUR AMPLITUDE]

This sets the blur amplitude of the Image Stabilizer during recording. (→ 51)

[1]/[2]/[3]/[4]/[5]

[BLUR FREQUENCY]

This sets the blur frequency of the Image Stabilizer. (→ 51)

[1]/[2]/[3]

[ATW SET]

When you press the WHITE BAL button, you can assign ATW.

[OFF]:	Does not assign ATW when the WHITE BAL button is pressed.
[Ach]:	Sets the White Balance mode to ATW when the WHITE BAL button is pressed to switch to [Ach].
[Bch]:	Sets the White Balance mode to ATW when the WHITE BAL button is pressed to switch to [Bch].
[PRST]:	Sets the White Balance mode to ATW when the WHITE BAL button is pressed to switch to [PRST].

[ATW TARGET R]

This fine-adjusts the intensity of red. (→ 66)

- This function's default setting is "0".

[ATW TARGET B]

This fine-adjusts the intensity of blue. (→ 66)

- This function's default setting is "0".



[WB PRESET]

Sets which White Balance mode to use when the WHITE BAL button is pressed to switch to the PRST position.

[3200K]/[5600K]/[VAR]

[WB VAR]

Sets the color temperature when the White Balance mode is set to [VAR]. (→ 67)

- 1 Touch [WB VAR].
 - 2 Touch  /  to adjust settings.
- You can select a value between 2000K and 15000K.
- 3 Touch [EXIT] to exit the menu screen.

- This function's default setting is "3200K".

[MF ASSIST]

When [ON] is selected, focus is automatically adjusted after you adjust it with the focus ring in Manual Focus Mode. (→ 60)

[ON]/[OFF]

[FOCUS ASSIST 1]

Sets the Focus Assist method for the FOCUS ASSIST button and the USER button to which [FOCUS ASSIST 1] is registered. (→ 57)

[EXPAND]/[PEAKING]/[BOTH]

[FOCUS ASSIST 2]

Sets the Focus Assist method for the USER button to which [FOCUS ASSIST 2] is registered. (→ 57)

This item is not available when [FOCUS ASSIST 1] is set to [BOTH].

- Set [FOCUS ASSIST 1] to [EXPAND] or [PEAKING]

[EXPAND]/[PEAKING]

[PEAKING COLOR]

You can set the peaking color for Focus Assist. (→ 59)

[Red]/[Blue]/[Yellow]/[White]

[PEAKING LEVEL]

You can set the peaking strength for Focus Assist. (→ 59)

- This function's default setting is "0".

[FOCUS RING DRIVE]

This sets the way you adjust focus with the focus ring. (→ 54)

[SPEED]/[COARSE]/[FINE]

[FOCUS MACRO]

This enables/disables the Focus Macro function.

[ON]/[OFF]

- If [ON] is selected, subjects at a distance of approximately 10 cm to infinity can be brought into focus when the zoom position is at the W end. (→ 49)

[AREA MODE]

You can set an Area Mode effect. (→ 92)

[INH]/[FOCUS]/[IRIS]/[Y GET]/[FOCUS/IRIS]/[FOCUS/Y GET]

[CUSTOM AF]

When [ON] is selected, Auto Focus works with customized [AF SPEED] and [AF SENSITIVITY] settings. (→ 55)

[ON]/[OFF]

[AF SPEED]

You can adjust the focus speed of Auto Focus. (→ 55)

- This function's default setting is "0".

[AF SENSITIVITY]

You can adjust the tracking sensitivity of Auto Focus. (→ 55)

- This function's default setting is "5".

[AF AREA WIDTH]

You can adjust the effective area width for Auto Focus according to the size of the subject. (→ 56)

[SET]/[OFF]

[WFM]

This enables/disables the Wave Form Monitor function. (→ 97)

[ON]/[OFF]

[WFM TYPE]

This sets the type of Wave Form Monitor. (→ 98)

[WAVE]/[VECTOR]/[WAVE/VECTOR]

[WFM POSITION]

This sets the display positions of Wave Form Monitor. (→ 98)

[TOP/LEFT]/[TOP/RIGHT]/[BOTTOM/LEFT]/[BOTTOM/RIGHT]

[ZEBRA]

Switch between the zebra display and marker display.

[ZEBRA 1]/[ZEBRA 2]*/[MARKER]*/[OFF]

* Not displayed when [ZEBRA DETECT 2]/[MARKER] is set to [OFF]. (→ 192)

- For information on the zebra display and marker display, refer to page 99.

[ZEBRA MODE]

This sets the display duration of the zebra display.

[CONTINUE]: Displays the zebra display until it is switched to another zebra display setting.

[MOMENT]: Displays the zebra display for approximately 5 seconds.

[BARS TYPE]

You can switch the type of color bars to be displayed when you press the BARS button. (→ 108)

[TYPE 1]	[TYPE 2]	[TYPE 3]
		

[SUB REC BUTTON]

Enable/disable of the sub recording start/stop button on the handle can be switched.

[INHIBIT]/[ACTIVE]

[FAST ZOOM]

When [ON] is selected, you can use Fast Zoom when operating the zoom with the zoom lever. (→ 50)

[ON]/[OFF]

[SUB ZOOM]

Enable/disable of the sub zoom lever on the handle can be switched. Zoom speed will be different depending on the setting.

[OFF]/[1]/[2]/[3]/[4]/[5]/[6]/[7]

- The larger the value is, the faster the zoom speed becomes, and vice versa.
- When [FAST ZOOM] is set to [ON] and [7] is selected, the zoom speed becomes as same as Fast Zoom.

[DIGITAL ZOOM]

Changes the zoom magnification setting of Digital Zoom. (→ 89)

[×2]/[×5]/[×10]/[TOGGLE]

[i.Zoom]

You can zoom in while maintaining the beauty of high-definition picture quality up to a magnification of 30×. (→ 50)

- Set [REC FORMAT] to a setting with a picture size of 1920×1080 or below. (→ 162)

[ON]/[OFF]

[ZOOM/FOCUS]

You can switch between operating controls such as the zoom lever and focus ring with this unit and operating them with the AG ROP application during AG ROP application connection. (→ 151)

[IP REMOTE]/[CAMERA]

- Selecting [IP REMOTE] enables you to operate this unit with the AG ROP application, while selecting [CAMERA] enables you to operate this unit directly.

Auto switch setting



All default settings are indicated with underlined text.

MENU : **[AUTO SW]** → **desired setting**

[A.IRIS]

This enables/disables Auto Iris for Auto Iris Mode. (→ 45)

[ON]/[OFF]

[AGC]

This enables/disables AGC for Auto Iris Mode. (→ 45)

[ON]/[OFF]

[AGC LIMIT]

Sets the maximum possible gain value for Auto Gain Mode. (→ 71)

[3 dB]/[6 dB]/[9 dB]/[12 dB]/[15 dB]/[18 dB]/[21 dB]/[24 dB]

[AUTO SHUTTER]

This enables/disables Auto Shutter for Auto Mode. (→ 45)

[ON]/[OFF]

[AUTO SLOW SHTR]

You can record bright pictures even in dark places by slowing the shutter speed.
Slow Shutter works in Auto Shutter Mode. (→ 72)

[ON]/[OFF]

- The shutter speed will be adjusted to one of the following values according to the ambient brightness. The value will differ depending on the frame rate of the [REC FORMAT].

Frame rates	Shutter speed
59.94p/59.94i/29.97p	1/30 or more
50.00p/50.00i/25.00p	1/25 or more
23.98p/24.00p	1/24 or more

- This item cannot be set during Freeze Frame. (→ 91)
- When the shutter speed becomes 1/30, 1/25 or 1/24, the screen may be seen as if frames are missed and after images may appear.

[ATW]

This enables/disables ATW for Auto Mode. (→ 45)

[ON]/[OFF]

[AF]

This enables/disables Auto Focus for Auto Mode. (→ 45)

[ON]/[OFF]

Recording Setup



All default settings are indicated with underlined text.

MENU  : [RECORD SETUP] → desired setting

[MEDIA SELECT]

Card slot can be selected separately to record motion pictures. (→ 42)

[SD CARD 1]/[SD CARD 2]

[2 SLOTS FUNC.]

You can set relay/simultaneous/background/dual codec recording.

- **Insert SD cards to card slot 1 and card slot 2.**

[OFF]:	Cancel the setting.
[RELAY REC] ^{*1} :	Set the relay recording
[SIMULTANEOUS] ^{*2} :	Set the simultaneous recording
[BACKGROUND] ^{*1, 3} :	Set the background recording
[DUAL CODEC] ^{*1, 2, 4} :	Set the dual codec recording

*1 This function is not available in the following cases:

- During Super Slow Recording (→ 105)
- In Variable Frame Rate Mode (→ 102)
- During the Interval Recording (→ 183)

*2 This item is not available when different types of SD cards (SDHC Memory Card/SDXC Memory Card) are used.

*3 This function is not available in the following cases:

- When [REC FORMAT] is set to a setting with a size of 4K (4096×2160) or UHD (3840×2160) (→ 162)
- When the bit rate of [REC FORMAT] is above 50 Mbps

*4 Set [REC FORMAT] to a setting that allows you to use dual codec recording. (→ 182)

■ Relay recording

This is simple Relay Recording. It is possible to continuously record on the SD card in the other card slot even when the available capacity of the SD card runs out during the recording.

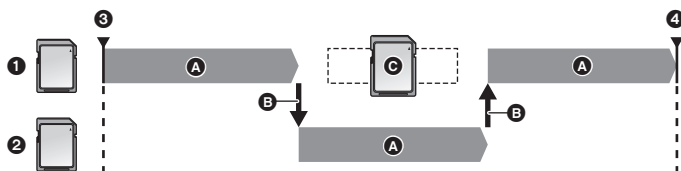

- | | |
|------------------------|---|
| 1 Slot 1 | A Recording |
| 2 Slot 2 | B The card slot used for recording is switched automatically. |
| 3 Recording is started | C Replace the SD card with a recordable one. |
| 4 Recording is paused | |

- **RELAY** is displayed beside the display of the SD card selected as the recording destination of motion pictures in [MEDIA SELECT] (→ 42). When the recording media is switched and Relay Recording starts, **RELAY** will disappear from the location and instead be displayed beside the other SD card display.
- Even after switching of the recording media, you can replace the SD card that ran out of space with a new one and record the motion picture onto three or more SD cards. Since it may take a while for this unit to recognize a new SD card, replace the SD card that ran out of space when the SD card currently being used as a destination still has sufficient remaining recordable time.
- The maximum recording time for Relay Recording is 10 hours.
- When the recording time of Relay Recording reaches 10 hours, the recording will stop temporarily. It will restart automatically a few seconds later.

■ Simultaneous recording

Same motion picture can be recorded on two SD cards.



- | | |
|------------------------|-------------|
| 1 Slot 1 | A Recording |
| 2 Slot 2 | |
| 3 Recording is started | |
| 4 Recording is paused | |

- **SIMUL** is displayed beside the display of the SD card selected as the recording destination of motion pictures in [MEDIA SELECT] (→ 42).
- If you set the recording destination of motion pictures to [SD CARD 1] in [MEDIA SELECT], they will also be recorded to [SD CARD 2] simultaneously.
- We recommend that you perform simultaneous recording using SD cards of the same Speed Class rating and capacity.

■ Background recording

You can continue recording a motion picture by recording it on the SD card that is not set as a recording destination in [MEDIA SELECT] (→ 42).

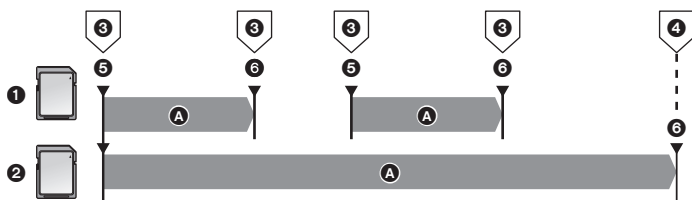

- 1 Slot 1
 - 2 Slot 2
 - 3 Press the recording start/stop button.
 - 4 Press and hold the USER button to which [BACKGROUND] is registered.
 - 5 Recording is started
 - 6 Recording is paused
- A Recording

- When the recording destination of motion pictures is set to [SD CARD 1] in [MEDIA SELECT], [SD CARD 2] will be used for background recording. The following instructions assume that the recording destination of motion pictures is set to [SD CARD 1].
- [BACKGR] is displayed beside the SD card display for card 2.

How to use background recording

- Register [BACKGROUND] to a USER button. (→ 84)

1 Press the recording start/stop button to start recording.

- A motion picture will start being recorded to the two SD cards. ([BACKGR] will be displayed in red.)
- If you press the USER button to which [BACKGROUND] is registered, you can start recording only to the SD card in card slot 2.
- For information on how to register a function to USER buttons, refer to page 84. For information on how to use the USER button to which [BACKGROUND] is registered, refer to page 95.

2 Press the recording start/stop button again to stop recording.

- Recording to the SD card in card slot 1 will stop, but recording to the SD card in card slot 2 will continue.
- You can repeat recording to the SD card in card slot 1 by pressing the recording start/stop button.
- You can stop background recording by pressing and holding the USER button to which [BACKGROUND] is registered.

■ Dual codec recording

You can make main and sub recordings in separate [REC FORMAT] settings.

Sub recording records scenes in a picture quality lower than that of the [REC FORMAT] setting for main recording.



1 Slot 1

2 Slot 2

3 Recording is started

4 Recording is paused

A Recording

B Recording in low picture quality

- If you set the recording destination of motion picture to [SD CARD 1] in [MEDIA SELECT] (→ 42), [SD CARD 1] will be used for main recording, while [SD CARD 2] will be used for sub recording.
- Set the sub recording scene setting in [DUAL CODEC REC].
- The icon for the card used for main recording will be displayed with [DUAL 50M] or [DUAL 8M].

(Relay recording)

- After performing the relay recording, a message about the remaining card capacity will be displayed. Replace the SD card that ran out of space or set [2 SLOTS FUNC.] to [OFF].

(Simultaneous recording)

- When performing simultaneous recording, even in the case where an error has occurred in one of the SD cards and recording has stopped, recording can be continued using the other SD card.
- When one of the media reaches its maximum recording time, the simultaneous recording stops.

(Background recording)

- An alert sound is not emitted for background recording.
- Background recording stops in the following cases:
 - When you have turned off this unit
 - When the SD card being used as a background recording destination runs out of space
- If the SD card being used as a background recording destination runs out of space during motion picture recording, background recording does not restart automatically even if you replace the SD card.

(Dual codec recording)

- Main recording does not stop even if an error occurs in the memory card used for sub recording. If an error occurs in the memory card used for main recording, the recording stops.
- When the main recording scene is automatically divided during recording, the sub recording scene will also be divided at the same time. (→ 44)

[DUAL CODEC REC]

This sets the sub recording scene settings for dual codec recording.

- For information on dual codec recording, refer to page 181.
- **Select a [REC FORMAT] setting that supports dual codec recording. (See below.)**

[FHD 50Mbps]: Performs recording at a bit rate of 50Mbps. Scenes can be saved in either MOV or MP4 format.

[FHD 8Mbps]: Performs recording at a bit rate of 8Mbps. Scenes can be saved in MOV format.

- Sub recording scenes will be recorded with the following settings:
 - Recording is performed with a size setting of FHD (1920×1080)
 - When [FHD 50Mbps] is selected, the [REC MODE] setting selected for sub recording will be the same as the setting selected for main recording (MOV/MP4).
 - Recording is performed at the same frame rate as that of the [REC FORMAT] setting for main recording.

■ [REC FORMAT] settings that support main recording of dual codec recording

(When [DUAL CODEC REC] is set to [FHD 50Mbps])

Recording mode	System frequency setting	Recording format
MOV, MP4	[59.94Hz]	UHD 2160/29.97p 100M, UHD 2160/23.98p 100M
	[50.00Hz]	UHD 2160/25.00p 100M

(When [DUAL CODEC REC] is set to [FHD 8Mbps])

Recording mode	System frequency setting	Recording format
MOV, MP4	[59.94Hz]	UHD 2160/29.97p 100M, UHD 2160/23.98p 100M, FHD 1080/59.94p ^{ALL-I} _{200M} , FHD 1080/59.94p 100M, FHD 1080/29.97p ^{ALL-I} _{200M} , FHD 1080/23.98p ^{ALL-I} _{200M}
	[50.00Hz]	UHD 2160/25.00p 100M, FHD 1080/50.00p ^{ALL-I} _{200M} , FHD 1080/50.00p 100M, FHD 1080/25.00p ^{ALL-I} _{200M}

- This function is not available in the following cases:
 - When [REC FORMAT] is set to a setting that does not support dual codec recording.

[INTERVAL REC]

A scene that moves slowly for long period of time is recorded frame by frame with an interval, and is recorded as a short time motion picture.

One frame is recorded every recording interval that is set.

- The number of frames per second differs depending on the frame rate of [REC FORMAT].
 - 59.94i or 29.97p: 30 frames make up a scene of 1 second
 - 50.00i or 25.00p: 25 frames make up a scene of 1 second
 - 24.00p: 24 frames make up a scene of 1 second
- To set [REC FORMAT] (→ 162)
- Following formats enable Interval Recording.

System Frequency setting	Recording format
[59.94Hz]	[4K 2160/24.00p 100M], [UHD 2160/29.97p 100M], [FHD 1080/29.97p 50M], [HA 1080/59.94i]
[50.00Hz]	[4K 2160/24.00p 100M], [UHD 2160/25.00p 100M], [FHD 1080/25.00p 50M], [HA 1080/50.00i]

[OFF]/[1 SEC.]/[10 SEC.]/[30 SEC.]/[1 MINUTE]/[2 MINUTES]

- [I-] is displayed on the screen. The icon changes to [I-REC] after recording starts.
- After recording, the setting of Interval Recording is canceled.
- Audio cannot be recorded.

(Setup examples based on a [SYSTEM FREQ] setting of [59.94Hz])

Setup example	Setup time (recording interval)	Recording time	Recorded time
Sunset	1 s	1 h	2 min
Blooming	30 s	3 h	12 s

- "h" is an abbreviation for hour, "min" for minute and "s" for second.
 - These times are approximations.
 - Maximum recordable time is 168 hours.
-
- This function is not available in the following cases:
 - During Freeze Frame (→ 91)
 - PRE-REC is used (→ 97, 184)
 - During Super Slow Recording (→ 105)
 - In Variable Frame Rate Mode (→ 102)
 - [INTERVAL REC] is canceled in the following cases.
 - If you turn the unit off
 - If you press the THUMBNAIL button
 - When [USB MODE SELECT] is set to [DEVICE] and this unit is connected to a PC. (→ 135)
 - If you set [REC FORMAT] unsupported for [INTERVAL REC].
 - The shortest motion picture recording time is approx. 2 second.
 - Color balance and focus may not be adjusted automatically depending on light sources or scenes. If so, manually adjust these settings. (→ 53, 64)
 - We recommend connecting the AC adaptor to this unit when recording images for a long period of time.

[VFR MODE]

This enables/disables Variable Frame Rate Mode.

In Variable Frame Rate Mode, you can record quick or slow motion picture by changing the frame rate before recording.

[ON]/[OFF]



- For information on how to use Variable Frame Rate Mode, refer to page 102.

[FRAME RATE]

You can adjust the frame rate for Variable Frame Rate Mode.

- Set [VFR MODE] to [ON]. (→ 102, 184)

1 Touch [FRAME RATE].

2 Touch  /  to adjust the frame rate.

- You can select a value between 2 fps and 60 fps or 2 fps and 50 fps.

3 Touch [EXIT] to complete the setting.

- The default setting varies depending on the [REC FORMAT] setting.
 - [FHD 1080/29.97p 50M]: “30fps”.
 - [FHD 1080/23.98p 50M]: “24fps”.
 - [FHD 1080/25.00p 50M]: “25fps”.
- When [REC MODE] and [REC FORMAT] are set to settings that are not available for Variable Frame Rate Mode, [FRAME RATE] cannot be set. (→ 102)

[SUPER SLOW REC]

This enables/disables Super Slow Recording. (→ 105)

[ON]/[OFF]

[PRE-REC]

This allows the recording of an image and audio to start before you press the recording start/stop button. AVCHD scenes will be recorded from approximately 3 seconds before the operation, while MOV/MP4 will be recorded from approximately 4 seconds before the operation. (→ 97)

[ON]/[OFF]

[INFRARED REC]

Selecting [ON] enables Infrared Recording Mode, allowing you to record images in the dark. (→ 94)

[ON]/[OFF]

[IR REC COLOR]

This changes the color in which images are recorded in Infrared Recording Mode.

[Green]/[White]

[FOCUS TRANSITION]

You can register a focus position to Focus Transition. (→ 61)

- **Switch to Manual Focus.** (→ 53)

[SET]/[OFF]

[FOCUS TRANSITION TIME]

You can set the length of time in which the focus will shift during Focus Transition. (→ 63)

[DIRECT]/[FASTEST]/[2-15 SEC.]/[20 SEC.]/[30 SEC.]/[45 SEC.]/[60 SEC.]/[90 SEC.]

- This function's default setting is 2 seconds.

[FOCUS TRANSITION REC]

You can start recording and Focus Transition simultaneously. (→ 63)

[1]/[2]/[3]/[OFF]

[FOCUS TRANSITION WAIT]

You can set the length of time before Focus Transition starts. (→ 63)

[0 SEC.]/[5 SEC.]/[10 SEC.]

[TIME STAMP]

You can stamp the date and time of recording on the images you record.

[ON]/[OFF]

- **R** appears on the screen.
- The display mode and format of the date and time of recording to be stamped vary depending on the settings for [DATE/TIME] and [DATE FORMAT]. (→ 194)
- The month of the date and time of recording is recorded in English.

- In the following cases, even when [TIME STAMP] is set to [ON], the date and time of recording are not displayed:
 - When [REC FORMAT] is set to [SA 480/59.94i] or [SA 576/50.00i] (→ 162)
 - When [2 SLOTS FUNC.] is set to [DUAL CODEC] (→ 178)
 - When [DATE/TIME] is set to [OFF]
 - During Freeze Frame (→ 91)
 - During Super Slow Recording (→ 105)
 - In Variable Frame Rate Mode (→ 102)
 - When this unit is connected to the SDI OUT terminal of the external device and the external output resolution is set to PsF (→ 131)
- Even when [VIDEO OUT OSD] is set to [OFF], the date and time of recording are displayed on the external monitor screen. (→ 129)
- The date and time of recording displayed during [TIME STAMP] recording and the date and time displayed during the playback of the image may not exactly be the same.

[DF MODE]

Selects the compensation mode for the time code. (→ 80)

- Set [SYSTEM FREQ] to [59.94Hz]. (→ 161)

[DF]/[NDF]

[TCG]

Sets the way the time code will move. (→ 80)

[FREE RUN]/[REC RUN]

[TC PRESET]

Initial value of the time code can be set. (→ 81)

[UB PRESET]

- Set [REC MODE] to [AVCHD]. (→ 161)

User Information can be set. (→ 81)

[EXT TC LINK]

You can synchronize the time code of the external device with that of this unit. (→ 83)

[MASTER]/[SLAVE]

Audio Setup



All default settings are indicated with underlined text.

 : [AUDIO SETUP] → desired setting

[AUDIO LOW CUT CH1]

Reduces the level of low-pitched sound for audio channel 1.

[ON]/[OFF]

- You may not see the full effect depending on the recording conditions.

[AUDIO LOW CUT CH2]

Reduces the level of low-pitched sound for audio channel 2.

[ON]/[OFF]

- You may not see the full effect depending on the recording conditions.

[AUDIO LEVEL CH1]

Switches the adjustment method of the audio recording level for audio channel 1. (→ 77)

[AUTO]/[MANUAL]

[AUDIO LEVEL CH2]

Switches the adjustment method of the audio recording level for audio channel 2. (→ 77)

[AUTO]/[MANUAL]

[AUDIO ALC LINK]

If you set this item to [ON], when ALC works for either of the audio channels, it will also work for the other audio channel. (→ 78)

- Set [AUDIO LEVEL CH1]/[AUDIO LEVEL CH2] to [MANUAL].
- Set [AUDIO ALC CH1]/[AUDIO ALC CH2] to [ON]. (→ 78)

[ON]/[OFF]

[AUDIO ALC CH1]

If you set this item to [ON], you can reduce the audio noise of audio channel 1.
It will record with natural sound when set to [OFF]. (→ 78)

- Set [AUDIO LEVEL CH1] to [MANUAL]. (→ 77)

[ON]/[OFF]

[AUDIO ALC CH2]

If you set this item to [ON], you can reduce the audio noise of audio channel 2.
It will record with natural sound when set to [OFF]. (→ 78)

- Set [AUDIO LEVEL CH2] to [MANUAL]. (→ 77)

[ON]/[OFF]

[INPUT1 LINE LEVEL]

Sets the input level of the audio equipment connected to AUDIO INPUT1 terminal (XLR 3 pin).

[+4dBu]/[0dBu]

[INPUT2 LINE LEVEL]

Sets the input level of the audio equipment connected to AUDIO INPUT2 terminal (XLR 3 pin).

[+4dBu]/[0dBu]

[INPUT1 MIC LEVEL]

Sets the input level of the external microphone connected to AUDIO INPUT1 terminal (XLR 3 pin).

[-40 dB]/[-50 dB]/[-60 dB]

[INPUT2 MIC LEVEL]

Sets the input level of the external microphone connected to AUDIO INPUT2 terminal (XLR 3 pin).

[-40 dB]/[-50 dB]/[-60 dB]

Output Setup

Different menu items are displayed depending on whether this unit is in Recording Mode or Playback Mode.

All default settings are indicated with underlined text.

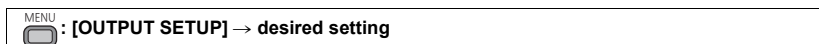

[OUTPUT SEL]



This changes the external output destination. (→ 130)

[HDMI]/[SDI]/[AV]

[RESOLUTION]



This changes the way in which images are output to an external device. (→ 130)

[SYSTEM]/[1080p]/[1080i]/[DOWN CONV.]

[REMOTE REC]



This enables/disables a function that controls recording performed with an external device connected to the unit.

[ON]/[OFF]

[REMOTE REC LINK]



When [ON] is selected, you can control recording performed with this unit and an external device using the recording start/stop button.

[ON]: Controls recording performed with this unit and an external device using the recording start/stop button.

[OFF]: Controls recording performed with an external device using the USER button function [AUTO REC]. (→ 100)

[SDI EDH]



When [ON] is selected, EDH is superimposed on images of SD signals (480i and 576i) output from the SDI OUT terminal.

- (In Playback Mode)

Touch the play mode select icon, and set this unit to Motion Picture Playback Mode. (→ 115)

[ON]/[OFF]

[SDI AUDIO GAIN CHG]



This adjusts the gain value of audio signals output from the SDI OUT terminal.

- Set [OUTPUT SEL] to [SDI]. (→ 130)
- (In Playback Mode)
Touch the play mode select icon, and set this unit to Motion Picture Playback Mode. (→ 115)

[0 dB]/[-6 dB]/[-12 dB]

- This function is not available in the following cases:
 - When [OUTPUT SEL] is set to [HDMI] or [AV] (→ 130)

[DOWN CONV.]



This function allows you to select how to display images with a 16:9 aspect ratio on an external monitor with a 4:3 aspect ratio. (→ 129)

- Set [RESOLUTION] to [DOWN CONV.]. (→ 130)

[SIDE CROP]/[LETTERBOX]/[SQUEEZE]

[HDMI UHD OUTPUT LIMIT]



This sets a frame rate when outputting scenes in the recording format [UHD 2160/59.94p 150M] or [UHD 2160/50.00p 150M] from the HDMI OUT terminal.

(When [SYSTEM FREQ] is set to [59.94Hz])

[59.94p]: Outputs scenes in 2160/59.94p.

[29.97p]: Outputs scenes in 2160/29.97p.

(When [SYSTEM FREQ] is set to [50.00Hz])

[50.00p]: Outputs scenes in 2160/50.00p.

[25.00p]: Outputs scenes in 2160/25.00p.

[HDMI TC OUTPUT]



Switches the output setting of time code information when this unit is connected to another device (HDMI-SDI converter, etc.) with an HDMI cable.

- To remotely record scenes to the external device connected to the HDMI OUT terminal using the USER button function [AUTO REC], select [ON]. (→ 100)
- (In Playback Mode)
Touch the play mode select icon, and set this unit to Motion Picture Playback Mode. (→ 115)

[ON]/[OFF]

[H/PHONE MODE]



Change the type of sound to be output from the headphone and AV OUT terminals.

[LIVE]: The sound which has been input from the microphone is output as is. This setting is selected when delays in the sound are annoying.

[RECORDING]: The sound in the status which is to be recorded (the sound synchronized with the images) is output.

- When an HDMI cable is connected to this unit, even if you select [LIVE], sound will be output according to [RECORDING].

[VOLUME]



When [ON] is selected, you can adjust the headphone volume in Recording Mode with the jog dial. (→ 114)

[ON]/[OFF]

[TEST TONE]



Selects the test tone output when color bars are displayed. (→ 108)

[OFF]: Does not output a test tone.

[LEVEL 1]: Outputs a high volume test tone.

[LEVEL 2]: Outputs a low volume test tone.

[LCD/EVF OUTPUT]



This sets how to turn on/off the LCD monitor and viewfinder. (→ 33)

[AUTO]/[LCD]

Display setting

Different menu items are displayed depending on whether this unit is in Recording Mode or Playback Mode.



All default settings are indicated with underlined text.

 : [DISP SETUP] → desired setting

[ZEBRA DETECT 1]



Selects the brightness level of the left-leaning zebra patterns on the screen.

- 1 **Touch [ZEBRA DETECT 1].**
 - Touch [YES].
- 2 **Touch  /  to adjust settings.**
 - You can select a value between 50% and 105%.
- 3 **Touch [EXIT] to complete the setting.**



- This function's default setting is "80%".

[ZEBRA DETECT 2]



Selects the brightness level of the right-leaning zebra patterns on the screen.

[SET]/[OFF]

- 1 **Touch [ZEBRA DETECT 2].**
 - Touch [SET].
- 2 **Touch  /  to adjust settings.**
 - You can select a value between 50% and 105%.
- 3 **Touch [EXIT] to complete the setting.**
 - You can display [ZEBRA 2] after setting the level. (→ 99, 174)

- This function's default setting is "100%".

[MARKER]



Displaying of the luminance level display marker can be switched.

[ON]/[OFF]

- Marker can be displayed when set to [ON]. (→ 99, 174)

[GUIDE LINES]



You can check if the image is level while recording motion pictures and still pictures. The function can also be used to estimate the balance of the composition.

[≡]/[田]/[田]/[OFF]

- The guidelines do not appear on the images actually recorded.
- The setting changes as follows when using Focus Assist. (→ 57)
 - The guidelines are not displayed. (They are displayed on the external monitor when this unit is connected to the external monitor.)
 - The setting cannot be changed.

[SAFETY ZONE]



Display of the range that can be displayed with the external monitor (safety zone **A**) can be switched.

(When [16:9 90%] is set)

Aspect ratio	[SAFETY ZONE]
16:9	[16:9 90%]/[4:3]/[14:9]/[1.85:1]/[17:9]/ [2:1]/[2.35:1]/[2.39:1]/[OFF]
4:3*	[4:3 90%]/[4:3]/[OFF]

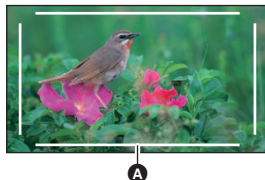

* When [REC FORMAT] is set to [SA 480/59.94i] or [SA 576/50.00i] and [ASPECT CONVERT] is set to [SIDE CROP] (→ 162, 166)

- The safety zone is not displayed on the images that is actually recorded.

[CENTER MARKER]



Displays/hides the center marker.

[ON]/[OFF]

[REC COUNTER]



Selects the operation of the Recording Counter during recording. (→ 82)

[TOTAL]/[SCENE]

[FOCUS DISPLAY]



This changes the units of focus values.

[NUMBER]	A value between 0 and 99 is displayed.
[feet]	All values are displayed in feet.
[m]	All values are displayed in meter.
[OFF]	No value is displayed.

[ZOOM DISPLAY]



This changes the units of zoom values.

[NUMBER]	A value between 0 and 99 is displayed.
[mm]	All values are displayed in millimeter.
[OFF]	No value is displayed.

[VIDEO OUT OSD]



The information displayed on the screen (operation icon and counter display etc.) can be displayed/not displayed on the external monitor. (→ 129)

[ON]/[OFF]

[DATE/TIME]



It is possible to change the date and time display mode.

[OFF]/[TIME]/[DATE]/[DATE&TIME]

[DATE FORMAT]



It is possible to change the date format.

[Y/M/D]/[M/D/Y]/[D/M/Y]

[LEVEL GAUGE]



This function displays the horizontal/vertical tilt of the unit with the electronic level. (→ 95)

[ON]/[OFF]

[AUDIO LEVEL METER]



Select to display the audio level meter.

- (In Playback Mode)

Touch the play mode select icon, and set this unit to Motion Picture Playback Mode.

(→ 115)

[ON]/[OFF]

[LENS STATUS]



Display relating to lens can be switched. (Zoom Display, Optical Image Stabilizer, ND filter, Focus Display, White Balance, Iris, Gain, Auto Iris, Shutter Speed)

[ON]/[OFF]

[CARD & BATTERY]



Display can be switched between the remaining recordable time of the SD card and the remaining battery capacity indication.

[ON]/[OFF]

[OTHER DISPLAY]



This shows or hides indications on the screen except for [USER BUTTON DISPLAY], [GUIDE LINES], [SAFETY ZONE], [CENTER MARKER], [DATE/TIME], [AUDIO LEVEL METER], [LENS STATUS] and [CARD & BATTERY].

[ON]/[OFF]

[POWER LCD]



This makes it easier to view the LCD monitor in bright places including outdoors. (→ 36)

[+1]/[0]/[-1]

- When the AC adaptor is in use, [+1] is automatically selected.

[LCD SET]



It adjusts brightness and color density on the LCD monitor. (→ 36)

[COLOR]/[BRIGHTNESS]/[CONTRAST]

- The default settings are as follows:
 - [COLOR]: "0"
 - [BRIGHTNESS]: "0"
 - [CONTRAST]: "0"

[EVF SETTING]



Adjusts the brightness and color intensity of the viewfinder. (→ 37)

[COLOR]/[BRIGHTNESS]/[CONTRAST]

- The default settings are as follows:
 - [COLOR]: “0”
 - [BRIGHTNESS]: “0”
 - [CONTRAST]: “0”

[EYE SENSOR]



Adjusts the eye sensor sensitivity. (→ 38)

- This function's default setting is “-2”.

[SELF SHOOT]



Switches the mirror function of the LCD monitor when recording yourself. (→ 38)

The image on the LCD monitor is displayed mirrored horizontally during recording of yourself when it is set to [MIRROR].

[MIRROR]/[NORMAL]

[EVF COLOR]



The recording images or playback images on the viewfinder can be selected between color/black and white. (→ 38)

[ON]/[OFF]

[EVF/LCD DETAIL]



Setting this item to [ON] helps you achieve focus easier by emphasizing the outlines of an image displayed on the LCD monitor and viewfinder. (→ 54)

[ON]/[OFF]

[EVF/LCD PEAK LEVEL]



Adjusts the emphasis strength for [EVF/LCD DETAIL]. (→ 54)

- This function's default setting is “0”.

[EVF/LCD PEAK FREQ.]



Sets the peaking frequency for [EVF/LCD DETAIL]. (→ 54)

[HIGH]/[LOW]

Other Functions

Different menu items are displayed depending on whether this unit is in Recording Mode or Playback Mode.

All default settings are indicated with underlined text.

 : **[OTHER FUNCTION]** → desired setting

[FORMAT MEDIA]



The SD card or the external media device can be formatted. (→ 43, 140)

- Please be aware that if a medium is formatted, then all the data recorded on the medium will be erased and cannot be restored. Back up important data on a PC etc. (→ 135)

[MEDIA STATUS]



The used space and remaining recordable time of the SD card can be checked.

- Touching [CHANGE MEDIA] switches the unit between the display for the SD card 1 and the display for the SD card 2.
- Only in Recording Mode, remaining recordable time for the selected recording format is displayed.
- Touch [EXIT] to close the indication.

- The SD card requires some space to store information and manage system files, so the actual usable space is slightly less than the indicated value. The usable space is generally calculated as 1 GB=1,000,000,000 bytes. The capacities of this unit, PCs and software are expressed as 1 GB=1,024×1,024×1,024=1,073,741,824 bytes. Therefore, the indicated value of the capacity appears to be smaller.

[PICTURE MEDIA SELECT]



You can specify the card slot to which still pictures are to be recorded.

- You can save the desired frame of a recorded motion picture as a still picture. (→ 120)

[SD CARD 1]/[SD CARD 2]

[REC LAMP]



The recording lamp lights up during recording. When this is set to [OFF], it does not light during recording.

[FRONT]/[REAR]/[BOTH]/[OFF]

[CLOCK SET]



Set date and time. (→ 39)

[TIME ZONE]



Set the time difference from Greenwich Mean Time. (→ 39)

[ALERT SOUND]



Touch screen operation, start and stop of recording can be confirmed with this sound.
When [OFF] is selected, the sound is not output at the start/end of recording, etc.

[OFF]/ (Volume low)/ (Volume high)

2 Beeps for 4 times

When an error occurs. Check the message displayed on the screen. (→ 207)

[ECONOMY (BATT)]



When about 5 minutes have passed without any operation, this unit automatically turns off to save battery life.

[ON]/[OFF]

- This unit will not automatically turn off even if the [ECONOMY (BATT)] is set to [ON] in following cases:
 - PRE-REC is used (→ 97, 184)
 - When [USB MODE SELECT] is set to [DEVICE] and this unit is connected to a PC. (→ 135)

[ECONOMY (AC)]



When connected to AC adaptor about 15 minutes have passed without any operation, this unit automatically turns off.

[ON]/[OFF]

- This unit will not automatically turn off even if the [ECONOMY (AC)] is set to [ON] in following cases:
 - PRE-REC is used (→ 97, 184)
 - When [USB MODE SELECT] is set to [DEVICE] and this unit is connected to a PC. (→ 135)

[SYSTEM FREQ]



Set the system frequency of this unit. (→ 161)

[USB MODE]



Enable/disable connections to the USB terminals of this unit. (→ 104)

[ON]/[OFF]

[USB MODE SELECT]



The unit's USB terminal to which a USB Cable will be connected can be switched.
Switch the terminal according to the shape of the USB Cable's plug you intend to connect to the unit.

[HOST]: For connecting to the USB HOST terminal (Type A) of the unit

[DEVICE]: For connecting to the USB DEVICE terminal (Type Micro-B) of the unit

[INITIAL SET]



The menu settings or [FILE SELECT] are reset to the default. (→ 152)

[ALL]:	This is for initializing all menus.*
[SCENE]:	This is for initializing the setting of each scene number of [FILE SELECT].
[NETWORK]:	This is for initializing the [NETWORK SETUP] menu settings.
[NO]:	This is for not performing initialization.

* Settings for [CLOCK SET], [TIME ZONE] and [SYSTEM FREQ] will not be changed.

- Returning all settings to the default is not possible during Freeze Frame. (→ 91)

[NUMBER RESET]



Set the file number of the next MOV/MP4 and still picture to be saved to 0001.

- Folder number is updated and file number will start from 0001. (→ 136)
- To reset the folder number, format the SD card, and then perform [NUMBER RESET].

[SOFTWARE INFO]



You can view the software information (License) on a PC connected to this unit with a USB 3.0 cable.

- Set [USB MODE SELECT] to [DEVICE]. (→ 198)
- Set [USB MODE] to [ON]. (→ 198)

1 Touch [SOFTWARE INFO].

2 Connect this unit to a PC. (→ 135)

- A message will be displayed when the connection is complete. On the PC, confirm [LICENSE.TXT].
- When using the battery, the LCD monitor turns off after about 5 seconds. Touch the screen to turn the LCD monitor on.

[LANGUAGE]



You can select the language on the screen display and the menu screen.

AG-UX180EJ

[English]/[Deutsch]/[Français]/[Italiano]/[Español]/[Русский]/[Nederlands]/[Česky]/
[Svenska]/[Magyar]/[Polski]/[Türkçe]

AG-UX180EN

[English]/[Español]

Network Setup



All default settings are indicated with underlined text.

MENU : [NETWORK SETUP] → desired setting

[USER ACCOUNT]

Set up a login user account for the AG ROP application. (→ 144)

[SET]/[OFF]

[WIRELESS SETUP]

Set the wireless LAN connection method. (→ 147)

[DIRECT]/[SSID(SELECT)]/[SSID(MANUAL)]

[Wireless LAN setup]

You can change or check the network setup, such as the IP address, subnet mask, and MAC address for wireless LAN connections. (→ 146)

[IP Address]/[Subnet Mask]/[Gateway]/[DHCP]/[MAC Address]

[CONNECTION HISTORY]

A history of connections made to wireless access points are displayed. You can easily connect with the same settings as used previously by selecting a connection record from History. (→ 150)

[NETWORK INITIAL SETTING]

You can change the [NETWORK SETUP] menu back to the default condition.

[NETWORK SETUP PASSWORD]

This will set/clear the Password to limit the startup of the [NETWORK SETUP] menu. By setting the Password, it will prevent erroneous operation, prevent wrongful use of the wireless LAN function by third party, and protect the set personal information.

[Setup]/[Delete]

1 Touch [Setup].

2 Enter a password (six characters).

- After finish entering the Password, touch [Enter].
- For details on how to enter characters, refer to page 145.

3 Re-enter the password.

- After finish entering the Password, touch [Enter].
 - If the Passwords match with each other, a message is displayed.
-
- After setting a password, you will be required to enter it each time you touch the [NETWORK SETUP] menu.
 - If you have forgotten the password, from the menu, select [OTHER FUNCTION] → [INITIAL SET] → [NETWORK]. This will reset the [NETWORK SETUP] menu to the default settings, allowing you to use it again.

Maintenance



MENU  : [MAINTENANCE] → desired setting

[VERSION]

The version of the firmware of this unit is displayed.

[UPDATE]

The firmware of this unit is updated. (→ 220)

[HOUR METER]

This displays the operation time of this unit, how many times the zoom lever has been operated, how many times the zoom motor has worked and how many times the jog dial has been pressed.

Video Setup



All default settings are indicated with underlined text.

- Press the **THUMBNAIL** button to switch this unit to the **Playback Mode**.
- Touch the play mode select icon, and set this unit to **Motion Picture Playback Mode**.
(→ 115)

 : **[VIDEO SETUP]** → desired setting

[REPEAT PLAY]

Playback of the first scene starts after playback of the last scene finishes when set to [ON]. (→ 121)

[ON]/[OFF]

[RESUME PLAY]

If playback of a scene was stopped halfway, the playback can be resumed from where it was stopped when set to [ON]. (→ 121)

[ON]/[OFF]

[SCENE PROTECT]

Scenes can be protected so that they are not deleted by mistake.

(Even if you protect some scenes, formatting the SD card will delete them.) (→ 124)

[DELETE]

Deletes a scene. (→ 123)

Picture Setup



- Press the THUMBNAIL button to switch this unit to the Playback Mode.
- Touch the play mode select icon, and set this unit to Still Picture Playback Mode. (→ 115)

MENU



: [PICT. SETUP] → desired setting

[SCENE PROTECT]

Still pictures can be protected so that they are not deleted by mistake.

(Even if you protect some still pictures, formatting the SD card will delete them.) (→ 124)

[DELETE]

Deletes a still picture. (→ 123)

Copy



- Press the THUMBNAIL button to switch this unit to the Playback Mode.

MENU



: [COPY] → desired setting

[COPY ONCE]

This copies all scenes and still pictures recorded with this unit that have never been copied to another device to the external media device connected to this unit. (→ 141)

[SELECT COPY]

This allows you to select and copy the scenes/still pictures. You can copy between the SD cards in this unit or from either of them to the external media device. (→ 125, 141)

[1 → 2]/[2 → 1]/[1 →]/[2 →]

Indications

■ Recording indications



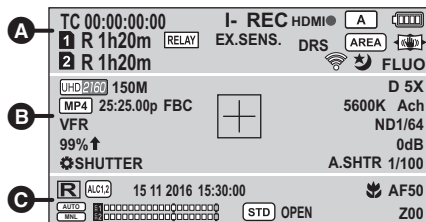





Example: Display in English



A	TC 00:00:00.00/TC 00:00:00:00 Counter display (→ 79)
I-	Interval Recording (→ 183)
I-REC (Red)	Interval Recording (Recording)
P-	PRE-REC (→ 97, 184)
P-REC (Red)	PRE-REC (Recording)
REC (Red)	Recording
REC (Flashing red)	Recording pause
SDI ●, SDI II, Automatic recording (→ 100) HDMI ●, HDMI III	
A	Auto Mode (→ 45)
	Remaining battery power (→ 28)
1, 2 (White)	Recording to card possible (motion picture)
1, 2 (Green)	Card is being recognized (motion picture)
R 1h20m	Remaining time for motion picture recording (→ 44)
MAIN	Card slot selected for motion picture recording (during normal recording) (→ 42, 44)
RELAY	Relay recording (→ 179)
SIMUL	Simultaneous recording (→ 179)
BACKGR	Background recording (→ 180)

DUAL 50M, DUAL 8M	Dual codec recording (→ 181, 182)
EX.SENS.	EXTENDED SENSITIVITY (→ 166)
H.SENS	High sensitivity recording mode (→ 167)
DRS	DRS (→ 91, 159)
AREA	Area Mode (→ 92)
AF-AREA	AF Area Width adjustment (→ 56)
Freeze	Freeze Frame (→ 91)
	Image Stabilizer (→ 51)
	Wireless LAN connection status (→ 147)
	AG ROP application connection status (→ 147)
	Infrared recording (→ 94, 184)
FLUO	The title of the scene number (→ 152)

B	4K2160, UHD2160, FHD1080, PS1080, PH1080, HA1080, HE1080, PM720, SA
	Recording format (→ 162)
ALL-I, 150M, 100M, 50M	Bit rate (→ 162)
D 2X, D 5X, D 10X	Digital Zoom (→ 89)

MOV , MP4	Recording mode (→ 161)	ALC1,2	When [AUDIO ALC CH1], [AUDIO ALC CH2] are enabled (→ 78)
100:25.00p	Frame rate during Super Slow Recording (→ 105, 184)	ALC1,2L	When [AUDIO ALC CH1], [AUDIO ALC CH2], [AUDIO ALC LINK] are enabled (→ 78)
25:25.00p	Frame rate in Variable Frame Rate Mode (→ 102, 184)	ALC	When [AUDIO ALC CH1], [AUDIO ALC CH2], [AUDIO ALC LINK] are enabled and audio cannot be recorded. (→ 102, 105)
59.94p, 59.94i, 50.00p, 50.00i, 29.97p, 25.00p, 24.00p, 23.98p	Frame rate (→ 162)		
FBC	Flash band compensation (→ 96, 167)		
5600K	Color temperature display (→ 64)		
ATW, LOCK, P3200K, P5600K, VAR, Ach, Bch	White Balance (→ 64)		
SUPER SLOW	Super Slow Recording (→ 105, 184)		
VFR	Variable Frame Rate mode (→ 102, 184)		
ND 1/4, ND 1/16, ND 1/64	ND filter (→ 109)		
99% ↑	Luminance level (→ 92, 99)		
	Luminance display frame (→ 99)		
+	Center Marker (→ 193)		
AGC, 0 dB	Gain value (→ 70)		
 SHUTTER	Multi Manual Function (→ 113)		
A.SHTR	Auto Shutter display (→ 72)		
1/100	Shutter speed (→ 72)		
1/100.0	Synchro Scan (→ 74)		
	Time Stamp recording in progress (→ 185)		
ALC1	When [AUDIO ALC CH1] is enabled (→ 78)		
ALC2	When [AUDIO ALC CH2] is enabled (→ 78)		
		15 NOV 2016 15:30:00	Time Stamp (→ 185)
		15 11 2016 15:30:00	Date indication
			Time indication (→ 39)
		S  E	Focus Transition bar (→ 62)
			Focus Macro (→ 104, 173)
		AF50, MF50, MA50, AF 00, MF 00, MA 00	Focus (→ 53)
		AUTO , MNL	[AUDIO LEVEL CH1], [AUDIO LEVEL CH2] (→ 77)
		i1  i2 	Audio level meter (→ 77)
		A.REC.	Sound recording disabled (→ 102, 105)
		STD	Auto iris mode (→ 68)
			Backlight Compensation (→ 87)
			Spotlight (→ 88)
		OPEN, F2.0	Iris value (→ 68)
		Z00, iZ00	Zoom magnification (→ 49, 50)
		iZ99	i.Zoom (→ 50)
		Z99	Fast Zoom (→ 50)

■ Playback indications

Example: Display in English

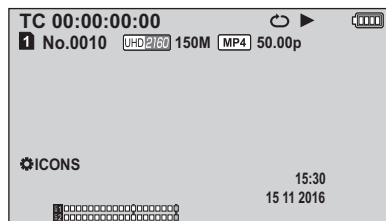

Display during playback (→ 115, 119)

TC 00:00:00.00/TC 00:00:00:00

Counter Display (→ 79)

1, 2 (White)	Card slot number
No.0010	Scene Number
100-0001	Still picture folder/file name
	Repeat Playback (→ 121)
15:30	Time indication (→ 39)
15 11 2016	Date indication (→ 39)
1, 2 (White)	Card slot selected as the recording destination of still pictures (→ 197)

8.8M, **8.3M**, **2.1M**, **0.9M**

Number of recording pixels for still pictures (→ 120)

In Playback Mode, the picture size is not displayed for still pictures recorded with other products that have different picture sizes from the sizes shown above.

R3000	Remaining number of still pictures (→ 120)
(Red)	Recording still picture (→ 120)

MOV, **MP4**, **AVCHD**

Recording mode (When thumbnails are displayed) (→ 115)

10 Scene Number (In 9-scene display in thumbnail mode) (→ 115)

4K, **UHD**, **FHD**, **DU50**, **DU8**, **PH**, **PS**, **HA**, **HE**, **PM**, **SA**

Recording format (When thumbnails are displayed) (→ 115, 162)

	Resume Playback (in thumbnail view) (→ 121)
	Protected motion pictures/still pictures (in thumbnail view) (→ 124)

■ Indication of connection to the external media device

Playback of the external media device (→ 142)

■ Indication of connection to other devices

Accessing the card (→ 136)

■ Confirmatory indications

-- (Time display) The built-in battery is low. (→ 39)

Warning for recording of yourself (→ 38)

SD card is not inserted.

P SD card is write-protected.

X SD card is non-compatible.

F SD card is full.

O Playback-only SD card

Messages

Major confirmation/error messages to be indicated on the screen in text.

During recording/playback

Display	Description	Behavior and cause
CHECK CARD.	The SD card is not supported by this unit.	<ul style="list-style-type: none"> • Check the SD card.
THIS CARD CANNOT RECORD IN VIDEO MODE.	This is displayed when the SD card has a capacity of less than 4 GB.	<ul style="list-style-type: none"> • Use an SD card with a capacity of 4 GB or more.
INCOMPATIBLE CARD. CHECK CARD SPEED.	This is displayed if the maximum writing speed of the SD card is not fast enough.	<ul style="list-style-type: none"> • The operation will continue. • Use an SD card with a maximum writing speed that is fast enough.
CANNOT EDIT.	The SD card cannot be used with this unit.	<ul style="list-style-type: none"> • Insert a recordable SD card.
CANNOT BE USED DUE TO INCOMPATIBLE DATA.		
Cannot be used due to incompatible data. Use another card.		
CANNOT RECORD - INCOMPATIBLE CONTROL DATA.	The content versions do not match. This is displayed when the SD card contains scenes recorded with another device, for example.	<ul style="list-style-type: none"> • Match the device and content version.
REC STOPPED. NOW WRITING.	This is displayed when the SD card is removed during recording or data cannot be written to the SD card correctly.	<ul style="list-style-type: none"> • Check the SD card.
ERROR OCCURRED. RECORDING IS STOPPED.		
ERROR OCCURRED. PLEASE TURN UNIT OFF, THEN TURN ON AGAIN.	This is displayed if the SD card is removed or writing to the SD card fails while recording is in progress. It is also displayed when the lens of the camera does not move.	<ul style="list-style-type: none"> • Check the SD card. • Turn off and on this unit, and then check to see if the lens moves.
CANNOT RECORD.THE NUMBER OF SCENES HAS EXCEEDED THE MAXIMUM LIMIT.	No additional scenes can be recorded to the SD card.	<ul style="list-style-type: none"> • Delete unnecessary scenes, or use a new SD card.

Display	Description	Behavior and cause
CANNOT RECORD - DATE CAPACITY IS FULL.	This is displayed when you try to record in excess of the maximum number of scenes allowed for one SD card.	<ul style="list-style-type: none"> ● The operation will stop. ● Replace the SD card or delete unnecessary scenes.
Cannot record - Playlist capacity is full.		
INVALID	This is displayed when the operation is invalid.	<ul style="list-style-type: none"> ● Before performing the operation, wait until this unit is ready for it.
ERROR - UNABLE TO REPAIR DATA.	This is displayed when the management information cannot be recovered.	<ul style="list-style-type: none"> ● Check the SD card.
CANNOT USE SD CARD IN VIDEO MODE, CONTROL DATA ERROR.		<ul style="list-style-type: none"> ● The operation will stop. ● Use another SD card to perform recording.
CONTROL DATA ERROR HAS BEEN DETECTED. (SD CARD)	Defective management information has been found.	<ul style="list-style-type: none"> ● The management information will be automatically recovered after this message is displayed.
SUPER SLOW MODE NO AUDIO RECORDING	Audio cannot be recorded if you record using Super Slow Recording.	<ul style="list-style-type: none"> ● To record audio, disable Super Slow Recording.
VFR ON, NO AUDIO RECORDING	Audio cannot be recorded if you change the frame rate when using Variable Frame Rate Mode.	<ul style="list-style-type: none"> ● To record audio, disable Variable Frame Rate Mode.
CANNOT PLAY.	This is displayed when an error in the recording folder name or file name has occurred, for example.	<ul style="list-style-type: none"> ● Check the SD card.
CANNOT PLAY THIS SCENE ON THIS MODEL.	The scene cannot be played back because it was recorded with another device.	<ul style="list-style-type: none"> ● Play back the scene with the device with which it was recorded.

During thumbnail and menu operation

Display	Description	Behavior and cause
NO DATA.	There are no scenes in the currently selected recording mode option and recording format option.	<ul style="list-style-type: none"> ● Select a recording mode option or recording format option containing recorded scenes.
CANNOT DELETE.	The content versions do not match. This is displayed when you try to delete scenes recorded with another device, for example.	<ul style="list-style-type: none"> ● Match the device and content version.
CARD ERROR. PLEASE REFORMAT.	This is displayed when the SD card cannot be formatted.	<ul style="list-style-type: none"> ● Check the SD card. ● Replace the SD card in the card slot at which the error has occurred.
UNABLE TO FORMAT.	Formatting is not possible due to, for example, a problem with the SD card.	<ul style="list-style-type: none"> ● Check the SD card.
Cannot delete data on card.	The SD card cannot be formatted.	
CANNOT PROTECT.	The content versions do not match. This is displayed when you try to set protection for scenes recorded with another device, for example.	<ul style="list-style-type: none"> ● Match the device and content version.
CANNOT RESET NUMBER.	The SD card cannot be used with this unit.	<ul style="list-style-type: none"> ● Insert a recordable SD card.
THUMBNAIL RECOVERY HAS FAILED.	This is displayed if the SD card is removed or writing to the SD card fails while recovery is in progress.	<ul style="list-style-type: none"> ● Check the SD card.
THUMBNAIL DATA ERROR IS DETECTED.	This is displayed when thumbnail information is not recorded correctly.	<ul style="list-style-type: none"> ● The applicable thumbnail information will be recovered after this message disappears.
CANNOT SELECT MORE SCENES.	The number of scenes that can be selected with this unit has reached the maximum limit.	<ul style="list-style-type: none"> ● Reselect scenes after finishing the current editing task.
SCENE FILE WRITE FAILED	This is displayed if the SD card is removed or writing to the SD card fails while a scene file is being saved.	<ul style="list-style-type: none"> ● Check the SD card.

During USB Device mode

Display	Description	Behavior and cause
DISCONNECT USB CABLE.	An error has occurred while accessing the SD card, or the OS is not supported.	<ul style="list-style-type: none">• Check the SD card.• Check to see if the OS is supported.

During USB Host mode

Display	Description	Behavior and cause
This external media cannot be used. Disconnect the USB cable from this unit.	This is displayed when the memory capacity of the external media is 32 GB or below or above 2 TB.	<ul style="list-style-type: none">• Connect a supported external media.
CANNOT CHECK CONNECTED DEVICE. DISCONNECT THE USB CABLE FROM THIS UNIT.	This is displayed when the device is connected to this unit with a product such as a USB hub.	<ul style="list-style-type: none">• Do not connect the devices with a product such as a USB hub. Connect to this unit directly.
FORMATTING FAILED.	The external media device cannot be formatted.	<ul style="list-style-type: none">• Change the connected external media device.
Formatting failed. Disconnect the USB cable from this unit.	This is displayed when an attempt to format the connected external media fails.	<ul style="list-style-type: none">• Check the connected external media.

During copying between SD cards or copying to an external media device

Display	Description	Behavior and cause
PLEASE CHECK THE EXTERNAL MEDIA.	Copying cannot be performed due to, for example, a problem with the copy destination media device.	<ul style="list-style-type: none"> • Check the copy destination media device.
Use destination media formatted with same as SD card.	<p>This is displayed when the SD card and copy destination media differ in their format (FAT32/exFAT)*.</p> <p>* FAT32 is a format used for SDHC memory cards. exFAT32 is a format used for SDXC memory cards.</p>	<ul style="list-style-type: none"> • Check the format of the copy destination media.
CANNOT COPY.	This is displayed when AVCHD scenes on the SD card and those on the copy destination media differ in their system frequency (59.94 Hz/50.00 Hz). (AVCHD scenes with different system frequencies cannot be recorded to the same media.)	<ul style="list-style-type: none"> • Copy AVCHD scenes to a recordable media so that their system frequency and that of AVCHD scenes on the media match.
SELECTED SCENES EXCEED CAPACITY.	The copy destination media lacks adequate space.	<ul style="list-style-type: none"> • Change the copy destination media, or delete unnecessary scenes.
Exceeds capacity. Please reselect.		
No scene to copy.	This is displayed when scenes specified as copy sources consist only of scenes recorded with other devices.	<ul style="list-style-type: none"> • Use an SD card containing scenes recorded with this unit.
THIS SCENE CANNOT BE COPIED.	This is displayed when one or more of the scenes you are trying to copy cannot be played back on this unit.	<ul style="list-style-type: none"> • Copy scenes except for the ones that cannot be copied.
Cannot copy: contains recordings from other devices.	This is displayed when a copy-related operation involving a scene recorded with another device is performed.	<ul style="list-style-type: none"> • Copy only the scenes recorded with this unit.
CANNOT SELECT BY DATE ANY MORE.	This is displayed when no more scenes can be selected after the maximum limit is reached, for example.	<ul style="list-style-type: none"> • After finishing copying, reselect the desired dates.

Display	Description	Behavior and cause
CANNOT COPY - DATE CAPACITY IS FULL.	This is displayed when no more scenes can be copied after the maximum limit set by applicable standards is reached, for example.	<ul style="list-style-type: none"> ● Use an SD card with enough recordable space.
CANNOT COPY - THE NUMBER OF SCENES HAS REACHED MAXIMUM.		
COULD NOT COPY SOME SCENES.	This is displayed when some scenes cannot be copied after the maximum limit set by applicable standards is reached, for example.	
COPY FAILED. PLEASE CHECK THE CARD.	An error has occurred while accessing the SD card.	<ul style="list-style-type: none"> ● Check the SD card.
Cannot copy due to error on media.	This is displayed when an attempt to access the SD card in this unit fails.	
Cancel card lock to write information.	The write-protect switch of the copy destination SD card is locked.	<ul style="list-style-type: none"> ● Unlock the write-protect switch of the SD card.





During wireless LAN connection

Display	Description	Behavior and cause
Connection to wireless access point failed.	This is displayed when a connection to the wireless access point cannot be established.	<ul style="list-style-type: none"> ● Check the settings for [WIRELESS SETUP] and [Wireless LAN setup], and the settings on the wireless access point.

Warning Indications

When an error is detected immediately after this unit is turned on or while it is being operated, the status indicator, on-screen displays and the AG ROP application screen (during AG ROP connection) inform you of the error.

System error	Status indicator	It flashes once per second.
	On-screen display	—
	AG ROP application screen	[WARNING] flashes four times per second.
	Meaning of the warning	A reference signal error or communication error has occurred.
	Recording/playback	The operation stops.
	Solution	Turn off and on this unit. If the warning persists, consult your dealer.
The battery is depleted (Low input voltage)	Status indicator	It flashes once per second.
	On-screen display	The message [LOW BATTERY.] is displayed.
	AG ROP application screen	[WARNING] lights up.
	Meaning of the warning	The battery is depleted.
	Recording/playback	The operation stops. This unit turns off automatically.
	Solution	Charge or replace the battery. Connect the AC adaptor to cancel the warning.
The card is full	Status indicator	—
	On-screen display	The remaining recordable time flashes red when it reaches [R 0h00m].
	AG ROP application screen	[WARNING] lights up until you perform some operation after the recording.
	Meaning of the warning	The SD card capacity is full.
	Recording/playback	The recording stops.
	Solution	Delete unnecessary scenes, or use a new SD card.

Recording error	Status indicator	It flashes once per second.
	On-screen display	—
	AG ROP application screen	[] flashes four times per second.
	Meaning of the warning	A recording error or recording circuit setting error has occurred.
	Recording/playback	The recording may either continue or stop.
	Solution	Turn off and on this unit. If the warning persists, consult your dealer.
Card error	Status indicator	—
	On-screen display	[] is displayed.
	AG ROP application screen	[] flashes four times per second.
	Meaning of the warning	An SD card error has occurred during recording or playback.
	Recording/playback	The operation stops.
	Solution	Replace the SD card.
The battery will be depleted soon	Status indicator	—
	On-screen display	The message [CHANGE THE BATTERY.] is displayed and  flashes red.
	AG ROP application screen	[] flashes once per second.
	Meaning of the warning	The battery will be depleted soon.
	Recording/playback	The operation continues.
	Solution	Charge or replace the battery as needed. Connect the AC adaptor to cancel the warning.

The card is nearly full	Status indicator	—
	On-screen display	The remaining recordable time flashes red. (When it is less than 1 minute)
	AG ROP application screen	[WARNING] flashes once per second. (When it is less than 1 minute)
	Meaning of the warning	The SD card is almost out of space.
	Recording/playback	The recording continues.
	Solution	Delete unnecessary scenes or use a new SD card as needed.
The cooling fan has stopped	Status indicator	It flashes twice per second.
	On-screen display	—
	AG ROP application screen	[WARNING] flashes four times per second.
	Meaning of the warning	A cooling fan error has stopped the cooling fan.
	Recording/playback	The operation stops and this unit turns off automatically.
	Solution	Check to see if the air inlet or outlet is blocked. If the warning persists, consult your dealer.

Troubleshooting

■ It is not a malfunction in following cases

The lens, the viewfinder or LCD monitor fog up.	<ul style="list-style-type: none"> This is due to condensation. This is not a malfunction. Please refer to page 9.
A clicking sound is heard when the unit is shaken.	<ul style="list-style-type: none"> This is the sound of the lens moving and is not a defect. This sound will no longer be heard when the unit is turned on and switch to Recording Mode.
Object seems to be warped.	<ul style="list-style-type: none"> Object seems to be warped slightly when the object moves across the image very fast, but this is because the unit is using MOS for the image sensor. This is not a malfunction.

Power

Problem	Check points
<p>This unit cannot be turned on.</p> <p>This unit does not stay on long enough.</p> <p>Battery runs down quickly.</p>	<ul style="list-style-type: none"> Charge the battery again to ensure it is sufficiently charged. (→ 24) In cold places, the battery using time becomes shorter. The battery has a limited life. If the operating time is still too short even after the battery is fully charged, the battery has worn out and needs to be replaced.
<p>This unit cannot be operated though it is turned on.</p> <p>This unit does not operate normally.</p>	<ul style="list-style-type: none"> Remove the battery or AC adaptor, wait about 1 minute and then reconnect the battery or AC adaptor. Then about 1 minute later, turn on the unit again. (Conducting the above operation while the SD card is being accessed may damage the data on the media.) If normal operation is still not restored, detach the power connected, and consult the dealer who you purchased this unit from.
<p>“ERROR OCCURRED. PLEASE TURN UNIT OFF, THEN TURN ON AGAIN.” is displayed.</p>	<ul style="list-style-type: none"> The unit has automatically detected an error. Restart the unit by turning off and on. The unit will be turned off in about 1 minute if the unit is not turned off and on. Repair is needed if it is repeatedly displayed even if it is restarted. Detach the power connected, and consult the dealer who you purchased this unit from. Do not attempt to repair the unit by yourself.

Indication

Problem	Check points
Function display (Remaining Display, Counter Display, etc.) is not displayed.	<ul style="list-style-type: none"> ● [CARD & BATTERY] or [OTHER DISPLAY] of the [DISP SETUP] is [OFF]. (→ 195) ● Press the COUNTER button to switch the counter display. (→ 79)

Recording

Problem	Check points
The unit arbitrarily stops recording.	<ul style="list-style-type: none"> ● Use an SD card that can be used for motion picture recording. (→ 30) ● The recordable time may have shortened due to the deterioration of the data writing speed or repeated recording and deletion. Using the unit, format the SD card. (→ 43)
Auto Focus function does not work.	<ul style="list-style-type: none"> ● If you are trying to record a scene which is hard to bring into focus in Auto Focus Mode, use the Manual Focus Mode to adjust the focus. (→ 46, 53)
Audio is not recorded.	<ul style="list-style-type: none"> ● Super Slow Recording, Variable Frame Rate Mode, or Interval Recording is enabled. (→ 102, 183) ● When Super Slow Recording or Variable Frame Rate Mode is enabled, A REC is displayed and audio is not recorded. ● Audio is not recorded for Interval Recording.
Color or brightness of the image changes, or you may see horizontal bars in the image. The LCD monitor flickers indoors.	<ul style="list-style-type: none"> ● Color or brightness of the image may change, or you may see horizontal bars in the image when the object is recorded under fluorescent light, mercury light or sodium light, etc., but this is not a malfunction. ● Record images in Auto Shutter Mode or adjust the shutter speed to 1/50, 1/60 or 1/100. ● Adjust the Synchro Scan shutter speed. (→ 74)

Playback

Problem	Check points
<p>Scenes/still pictures cannot be played back.</p>	<ul style="list-style-type: none"> ● Any scenes/still pictures where the thumbnails are displayed as cannot be played back. ● In most cases, is displayed for the following scenes: <ul style="list-style-type: none"> – Scenes recorded with another device or edited with editing software – Scenes with damaged data ● The thumbnails of scenes recorded on other devices with different system frequencies are indicated with . You can play them back by changing the [SYSTEM FREQ] setting. (→ 198)
<p>Scenes/still pictures cannot be deleted.</p>	<ul style="list-style-type: none"> ● Release the protect setting. (→ 124) ● It may not be possible to delete the following scenes/still pictures: <ul style="list-style-type: none"> – Any scenes/still pictures where the thumbnails are displayed as <p>If the scenes/still pictures are unnecessary, format the SD card to erase the data. (→ 43) Please be aware that if a SD card is formatted then all the data recorded on the SD card is erased and cannot be recovered. Back up important data on a PC etc.</p>

With other products

Problem	Check points
<p>Although this unit is correctly connected to an external monitor, images cannot be seen.</p> <p>The images are squeezed horizontally.</p>	<ul style="list-style-type: none"> ● Please read the operating instructions of your external monitor and select the channel that matches the input used for the connection. ● Change the setting of the unit depending on the cable connecting to the external monitor. (→ 130)
<p>Even when this unit is connected to the external monitor by the HDMI cable, images or sounds are not output.</p>	<ul style="list-style-type: none"> ● Check if the HDMI cable is connected correctly. ● Insert the HDMI cable all the way in.
<p>If the SD card is inserted in another device, it is not recognized.</p>	<ul style="list-style-type: none"> ● Check that the device is compatible with the capacity or type of SD card (SDHC Memory Card/SDXC Memory Card) that you inserted. Refer to the operating instructions of the device for details.
<p>When connected by the USB Cable, this unit is not detected by the other devices.</p>	<ul style="list-style-type: none"> ● When connected to other devices using only the battery, reconnect using the AC adaptor.

With a PC	
Problem	Check points
When connected by the USB Cable, this unit is not detected by the PC.	<ul style="list-style-type: none"> • After re-inserting the SD card into the unit, reconnect the USB Cable. • Select another USB terminal on the PC. • Check the operating environment. (→ 134) • Connect the USB Cable again after restarting the PC and turning on this unit again.
When the USB Cable is disconnected, an error message will appear on the PC.	<ul style="list-style-type: none"> • To disconnect the USB Cable safely, double-click the  icon in the task tray and follow the instructions on the screen.

Others	
Problem	Check points
If the SD card is inserted in this unit, it is not recognized.	<ul style="list-style-type: none"> • If the SD card is formatted on a PC, it may not be recognized by this unit. Use this unit to format SD cards. (→ 43)

■ If AVCHD scenes do not change smoothly when played back on another device

The images may be still for several seconds at the joins between the scenes if the following operations are performed when multiple scenes have been continuously played back using another device.

- Just how smoothly the scenes will be played back depends on the playback device. Depending on the device used, the images may stop moving and become still for a moment even when none of the following conditions are applicable.
- A continuous recording of motion picture data that exceeds 4 GB may momentarily stop at every 4 GB of data when played back with another device.

Principal reasons for not playing back smoothly
• The recording format [PS] was switched to another recording format when a scene was recorded
• When the scenes were recorded on different dates
• When scenes lasting under 3 seconds have been recorded
• When PRE-REC was used for recording
• When the Interval Recording is used
• When deleting scenes
• When scenes recorded more than 99 scenes on the same date

About recovery

If faulty management information is found, the messages may appear and a repair is performed. (Repairing may take time depending on the error.)

-  is displayed when abnormal management information is detected when the scenes are displayed in thumbnail.
-

- Use a sufficiently charged battery or the AC adaptor.
- Depending on the condition of the data, it may not be possible to completely repair the data.
- If recovery fails, it will not be possible to play back scenes recorded before the unit turned off.
- When data recorded on another device is recovered, it may not be possible to play back the data on this unit or the other device.
- If recovery fails, turn the unit off and on again after waiting awhile. If recovery fails repeatedly, format a media on the unit. Please be aware that if a media is formatted, then all the data recorded on the media will be erased.
- If the thumbnail information is recovered, displaying the thumbnails may become slower.

Others

Updating the firmware incorporated into the unit

Check the version of the camera in the main menu → [MAINTENANCE] → [VERSION], access the latest information on the firmware from the website described below, and then download the firmware as needed.

- Update completes by loading the downloaded files to the camera via the SD card. For details on update, visit the support desk at the following website:
<http://pro-av.panasonic.net/>

About copyright

■ Carefully observe copyright laws

IMPORTANT

“Unauthorized recording of copyrighted television programs, video tapes and other materials may infringe the right of copyright owners and be contrary to copyright laws.”

■ Licenses

- SDXC Logo is a trademark of SD-3C, LLC.
- “AVCHD”, “AVCHD Progressive” and the “AVCHD Progressive” logo are trademarks of Panasonic Corporation and Sony Corporation.
- Manufactured under license from Dolby Laboratories. Dolby and the double-D symbol are trademarks of Dolby Laboratories.
- The terms HDMI and HDMI High-Definition Multimedia Interface, and the HDMI Logo are trademarks or registered trademarks of HDMI Licensing, LLC in the United States and other countries.
- LEICA is a registered trademark of Leica Microsystems IR GmbH.
- DICOMAR is a registered trademark of Leica Camera AG.
- Microsoft® and Windows® are either registered trademarks or trademarks of Microsoft Corporation in the United States and/or other countries.
- Microsoft product screen shot(s) reprinted with permission from Microsoft Corporation.
- Intel®, Pentium®, Celeron® and Intel®Core™ are trademarks of Intel Corporation in the U.S. and/or other countries.
- Mac and macOS are trademarks of Apple Inc. registered in the U.S. and other countries.
- iPad is a trademark of Apple Inc., registered in the U.S. and other countries.
- App Store is a service mark of Apple Inc.
- “Wi-Fi®” is a registered trademark of Wi-Fi Alliance®.

- “WPA™”, and “WPA2™” are trademarks of Wi-Fi Alliance®.
- Other names of systems and products mentioned in these instructions are usually the registered trademarks or trademarks of the manufacturers who developed the system or product concerned.

This product is licensed under the AVC Patent Portfolio License for the personal use of a consumer or other uses in which it does not receive remuneration to (i) encode video in compliance with the AVC Standard (“AVC Video”) and/or (ii) decode AVC Video that was encoded by a consumer engaged in a personal activity and/or was obtained from a video provider licensed to provide AVC Video. No license is granted or shall be implied for any other use. Additional information may be obtained from MPEG LA, L.L.C.

See <http://www.mpegla.com>

- Separate license contracts must be obtained from MPEG LA where SD Memory Cards containing information recorded with this product are to be distributed to end users for commercial purposes. “End user” refers to persons or organizations handling such contents for personal use.

This product incorporates the following software:

- (1) the software developed independently by or for Panasonic Corporation,
- (2) the software owned by third party and licensed to Panasonic Corporation,
- (3) the software licensed under the GNU General Public License, Version 2.0 (GPL V2.0),
- (4) the software licensed under the GNU LESSER General Public License, Version 2.1 (LGPL V2.1), and/or
- (5) open source software other than the software licensed under the GPL V2.0 and/or LGPL V2.1.

The software categorized as (3) - (5) are distributed in the hope that it will be useful, but WITHOUT ANY WARRANTY, without even the implied warranty of MERCHANTABILITY or FITNESS FOR A PARTICULAR PURPOSE. Refer to the detailed terms and conditions thereof, which can be accessed by selecting [SOFTWARE INFO] in "Other Functions" as described in "Using the Menu" in the Operating Instructions (PDF format).

At least three (3) years from delivery of this product, Panasonic will give to any third party who contacts us at the contact information provided below, for a charge no more than our cost of physically performing source code distribution, a complete machine-readable copy of the corresponding source code covered under GPL V2.0 or LGPL V2.1, as well as the respective copyright notice thereof.

Contact Information:
oss-cd-request@gg.jp.panasonic.com

The source code and the copyright notice are also available for free in our website below.
<http://panasonic.net/avc/oss/index.html>

Recording functions that cannot be used simultaneously

Due to the specifications of this unit, depending on the recording function being used, it is not possible to use or select certain other recording functions.

- “○”: Available; “—”: Not available*

* “Not available” includes instances where the desired function cannot be used or selected.

Recording function to be set	Currently set recording function						
	Interval Rec	Super Slow Recording	VFR Mode	Relay recording	Simultaneous recording	Background recording	Dual codec recording
Interval Rec (→ 183)		—	—	—	○	—	—
Super Slow Recording (→ 105, 184)	—		—	—	○	—	—
VFR Mode (→ 102, 184)	—	—		—	○	—	—
Relay recording (→ 178)	—	—	—		—	—	—
Simultaneous recording (→ 178)	○	○	○	—		—	—
Background recording (→ 178)	—	—	—	—	—		—
Dual codec recording (→ 178)	—	—	—	—	—	—	
PRE-REC (→ 97, 184)	—	—	—	○	○	—	○
Black Fade (→ 88)	—	—	—	○	○	○	○
White Fade (→ 88)	—	—	—	○	○	○	○
Time Stamp (→ 185)	○	—	—	○	○	○	—
Recording Check (→ 90)	—	○	○	○	—	—	○
Last Scene Delete (→ 90)	—	○	○	○	—	—	—

Recording modes/approximate recordable time

- SD cards are only mentioned with their main memory size. The stated times are the approximate recordable times for continuous recording.
 - “h” is an abbreviation for hour, “min” for minute and “s” for second.
 - If recording for long periods, prepare batteries for 3 or 4 times the period you wish to record for. (→ 27)
 - The default setting for [REC MODE] is [MP4], and the default setting for [REC FORMAT] is [UHD 2160/50.00p 150M].
 - Maximum continuously recordable time for one scene: 10 hours*
 - The recording is paused once when the recording time for one scene exceeds 10 hours, and the recording will automatically resume after a few seconds.*
 - For information on the maximum continuous recordable time for one scene during Super Slow Recording, refer to page 106.
 - For information on the maximum continuous recordable time for one scene in Variable Frame Rate Mode, refer to page 104.
 - The recordable time may be reduced if recording with a lot of action is recorded or recording of short scene is repeated.
 - The recordable times depends on the recording condition or card type to be recorded.
 - For information on picture sizes, frame rates, and bit rates in [REC FORMAT], refer to page 162.
 - * The time also applies to scenes recorded with [RELAY REC] in [2 SLOTS FUNC.]. (→ 179)
- **When [REC MODE] is set to [MOV] or [MP4]**

Recording format	System frequency setting (→ 161)	SD card		
		4 GB	16 GB	64 GB
[4K 2160/24.00p 100M]	[59.94Hz]/ [50.00Hz]	—	20 min	1 h 20 min
[UHD 2160/59.94p 150M]	[59.94Hz]	—	—	55 min
[UHD 2160/29.97p 100M]		—	20 min	1 h 20 min
[UHD 2160/23.98p 100M]		—	10 min	40 min
[FHD 1080/59.94p <small>ALL- 200M</small>]		20 min	1 h 20 min	
[FHD 1080/59.94p 100M]		10 min	40 min	2 h 40 min
[FHD 1080/59.94p 50M]		—	10 min	40 min
[FHD 1080/29.97p <small>ALL- 200M</small>]		10 min	40 min	2 h 40 min
[FHD 1080/23.98p <small>ALL- 200M</small>]		—	10 min	40 min
[FHD 1080/29.97p 50M]		10 min	40 min	2 h 40 min
[FHD 1080/23.98p 50M]		10 min	40 min	2 h 40 min
[FHD 1080/59.94i 50M]		10 min	40 min	2 h 40 min

Recording format	System frequency setting (→ 161)	SD card		
		4 GB	16 GB	64 GB
[UHD 2160/50.00p 150M]	[50.00Hz]	—	—	55 min
[UHD 2160/25.00p 100M]		—	20 min	1 h 20 min
[FHD 1080/50.00p <small>ALL-I 200M</small>]		—	10 min	40 min
[FHD 1080/50.00p 100M]		—	20 min	1 h 20 min
[FHD 1080/50.00p 50M]		10 min	40 min	2 h 40 min
[FHD 1080/25.00p <small>ALL-I 200M</small>]		—	10 min	40 min
[FHD 1080/25.00p 50M]		10 min	40 min	2 h 40 min
[FHD 1080/50.00i 50M]		10 min	40 min	2 h 40 min

• When [REC MODE] is set to [AVCHD]

Recording format	System frequency setting (→ 161)	SD card		
		4 GB	16 GB	64 GB
[PS 1080/59.94p]	[59.94Hz]	19 min	1 h 20 min	5 h 20 min
[PH 1080/59.94i]		21 min	1 h 30 min	6 h
[PH 1080/23.98p]		30 min	2 h	8 h 30 min
[HA 1080/59.94i]		1 h 30 min	6 h 40 min	27 h 30 min
[PM 720/59.94p]		1 h	4 h 15 min	17 h 10 min
[SA 480/59.94i]		1 h	4 h	16 h 30 min
[PS 1080/50.00p]		[50.00Hz]	19 min	1 h 20 min
[PH 1080/50.00i]	21 min		1 h 30 min	6 h
[HA 1080/50.00i]	30 min		2 h	8 h 30 min
[HE 1080/50.00i]	1 h 30 min		6 h 40 min	27 h 30 min
[PM 720/50.00p]	1 h		4 h 15 min	17 h 10 min
[SA 576/50.00i]	1 h		4 h	16 h 30 min

Approximate number of recordable pictures

- SD cards are only mentioned with their main memory size. The stated number is the approximate number of recordable pictures.

Picture size	Aspect ratio	SD card		
		4 GB	16 GB	64 GB
8.8M 4096×2160	17:9	700	2900	11500
8.3M 3840×2160	16:9	750	3000	12000
2.1M 1920×1080		3200	12500	52000
0.9M 1280×720		7000	29000	118000

- Maximum number of recordable pictures that can be displayed is 9999. If the number of recordable pictures exceeds 9999, R 9999+ is displayed. The number will not change when the picture is taken until the number of recordable pictures is 9999 or less.
- The number of recordable pictures depends on the recording condition or card type to be recorded.
- The memory capacity indicated on the label of an SD card is the total of the capacity for copyright protection and management and the capacity which can be used on the unit, a PC etc.

Specification

Memory Card Camera-Recorder

General

Power:

DC 7.28 V (When using battery)

DC 12 V (When using AC adaptor)

Power consumption:

19.7 W (When using LCD monitor)

 indicates safety information

Ambient operating temperature:

0 °C to 40 °C

Ambient operating humidity:

10%RH to 80%RH (no condensation)

Mass:

Approx. 2.0 kg

(body only, excluding lens hood, battery, and accessories)

Approx. 2.4 kg

(including lens hood, supplied battery, and eye cup)

Dimensions (W×H×D):

173 mm×195 mm×346 mm

(excluding eye cup and projecting parts)

Camera unit

Pickup device:

1.0-type (effective size) MOS solid state image sensor

Number of pixels:

FHD (1920×1080), UHD (3840×2160);

8.79 million pixels

4K (4096×2160) 24.00p; 9.46 million pixels

Lens:

Optical image stabilizer lens, optical 20× motorized zoom

F value (focal length)

F2.8 to F4.5 (f=8.8 mm to 176 mm)

35 mm conversion

FHD (1920×1080), UHD (3840×2160);

25.4 mm to 508.0 mm

4K (4096×2160) 24.00p;

24.0 mm to 480.0 mm

Filter diameter; 67 mm

ND filter; OFF, 1/4, 1/16, 1/64

Shortest shooting distance (M.O.D.);

1.0 m from the lens

IR filter; incorporates the ON/OFF control function

Gain setting:

L/M/H selector button (toggle button)

In normal mode; 0 dB to 24 dB

When [EXTENDED SENSITIVITY] is enabled;

−3 dB to 24 dB

- Adjustable in 1 dB steps (automatic setting can also be assigned to L/M/H.)
- When assigning [SUPER GAIN] to the USER button: 30 dB or 36 dB

Color temperature setting:

[ATW], [ATW LOCK], [Ach], [Bch],

preset 3200K, preset 5600K, VAR (2000K to

15000K)

Shutter speed:

When [SYSTEM FREQ] = [59.94Hz]

- 60i/60p mode;
1/60, 1/100, 1/120, 1/180, 1/250, 1/350,
1/500, 1/750, 1/1000, 1/1500, 1/2000,
1/3000, 1/4000, 1/8000 sec.
- 30p mode;
1/30, 1/50, 1/60, 1/100, 1/120, 1/180, 1/250,
1/350, 1/500, 1/750, 1/1000, 1/1500, 1/2000,
1/3000, 1/4000, 1/8000 sec.
- 24p mode;
1/24, 1/48, 1/50, 1/60, 1/100, 1/120, 1/180,
1/250, 1/350, 1/500, 1/750, 1/1000, 1/1500,
1/2000, 1/3000, 1/4000, 1/8000 sec.

When [SYSTEM FREQ] = [50.00Hz]

- 50i/50p mode;
1/50, 1/60, 1/100, 1/125, 1/180, 1/250,
1/350, 1/500, 1/750, 1/1000, 1/1500, 1/2000,
1/3000, 1/4000, 1/8000 sec.
- 25p mode;
1/25, 1/50, 1/60, 1/100, 1/125, 1/180, 1/250,
1/350, 1/500, 1/750, 1/1000, 1/1500, 1/2000,
1/3000, 1/4000, 1/8000 sec.

Slow shutter speed:

When [SYSTEM FREQ] = [59.94Hz]

- 60i/60p mode;
1/2, 1/4, 1/8, 1/15, 1/30 sec.
- 30p mode;
1/2, 1/4, 1/8, 1/15 sec.
- 24p mode;
1/2, 1/3, 1/6, 1/12 sec.

When [SYSTEM FREQ] = [50.00Hz]

- 50i/50p mode;
1/2, 1/3, 1/6, 1/12, 1/25 sec.
- 25p mode;
1/2, 1/3, 1/6, 1/12 sec.

Synchro scan shutter:

When [SYSTEM FREQ] = [59.94Hz]

- 59.94i/59.94p;
1/60.0 to 1/249.7 sec.
- 29.97p;
1/30.0 to 1/249.7 sec.
- 23.98p;
1/24.0 to 1/249.6 sec.
- 24.00p;
1/24.0 to 1/249.9 sec.

When [SYSTEM FREQ] = [50.00Hz]

- 50i/50p;
1/50.0 to 1/250.0 sec.
- 25p;
1/25.0 to 1/250.0 sec.

VFR recording frame rate:

When [SYSTEM FREQ] = [59.94Hz]

- 30p mode;
2, 15, 26, 28, 30, 32, 34, 45, 60 (fps)
- 24p mode;
2, 12, 20, 22, 24, 26, 28, 36, 48, 60 (fps)

When [SYSTEM FREQ] = [50.00Hz]

- 25p mode;
2, 12, 21, 23, 25, 27, 30, 37, 50 (fps)

Super Slow Recording:

When [SYSTEM FREQ] = [59.94Hz]

Recording frame rate; FHD 120 fps
Slow motion effect;
1/4 the normal speed (30p mode),
1/5 the normal speed (24p mode)

When [SYSTEM FREQ] = [50.00Hz]

Recording frame rate; FHD 100 fps
Slow motion effect;
1/4 the normal speed (25p mode)

Sensitivity:

When [HIGH SENS. MODE] = [HIGH SENS.]

F11 (2000 lx, 3200 K, 89.9% reflection,
1080/59.94i)

F12 (2000 lx, 3200 K, 89.9% reflection,
1080/50.00i)

Minimum subject illumination:

0.2 lx (F2.8, gain 18 dB,
shutter speed 1/2 sec.,
when [HIGH SENS. MODE] = [HIGH SENS.]

Digital zoom:

2×/5×/10×/i.Zoom (max. 30×)

Lens hood:

Hood with lens cover

Memory card recorder

Recording media:

SDHC Memory Card (4 GB to 32 GB)/
SDXC Memory Card (48 GB to 128 GB);
UHS-I supported

Refer to page 30 for details on SD cards usable in this unit.

Recording slots:

2 slots

System frequency:

59.94 Hz, 50.00 Hz

Motion picture recording:

Recording method; MOV, MP4, AVCHD

Recording format;

- When [REC MODE] = [MOV], [MP4]
[4K 2160/24.00p 100M];
Average 100 Mbps (VBR)

(When [SYSTEM FREQ] = [59.94Hz])

[UHD 2160/59.94p 150M];

Average 150 Mbps (VBR)

[UHD 2160/29.97p 100M]/

[UHD 2160/23.98p 100M];

Average 100 Mbps (VBR)

[FHD 1080/59.94p ^{ALL-I}_{200M}]/

[FHD 1080/29.97p ^{ALL-I}_{200M}]/

[FHD 1080/23.98p ^{ALL-I}_{200M}];

Average 200 Mbps (VBR)

[FHD 1080/59.94p 100M];

Average 100 Mbps (VBR)

[FHD 1080/59.94p 50M]/

[FHD 1080/29.97p 50M]/

[FHD 1080/23.98p 50M]/

[FHD 1080/59.94i 50M];

Average 50 Mbps (VBR)

(When [SYSTEM FREQ] = [50.00Hz])

[UHD 2160/50.00p 150M];

Average 150 Mbps (VBR)

[UHD 2160/25.00p 100M];

Average 100 Mbps (VBR)

[FHD 1080/50.00p ^{ALL-I}_{200M}]/

[FHD 1080/25.00p ^{ALL-I}_{200M}];

Average 200 Mbps (VBR)

[FHD 1080/50.00p 100M];

Average 100 Mbps (VBR)

[FHD 1080/50.00p 50M]/

[FHD 1080/25.00p 50M]/

[FHD 1080/50.00i 50M];

Average 50 Mbps (VBR)

- When [REC MODE] = [AVCHD]

(When [SYSTEM FREQ] = [59.94Hz])

[PS 1080/59.94p]; Average 25 Mbps (VBR)

[PH 1080/59.94i]; Average 21 Mbps (VBR)

[PH 1080/23.98p]; Average 21 Mbps (VBR)

[HA 1080/59.94i]; Average 17 Mbps (VBR)

[HE 1080/59.94i]; Average 5 Mbps (VBR)

[PM 720/59.94p]; Average 8 Mbps (VBR)

[SA 480/59.94i]

(When [ASPECT CONVERT] = [SIDE

CROP], [SQUEEZE]);

Average 9 Mbps (VBR)

(When [SYSTEM FREQ] = [50.00Hz])

[PS 1080/50.00p]; Average 25 Mbps (VBR)

[PH 1080/50.00i]; Average 21 Mbps (VBR)

[HA 1080/50.00i]; Average 17 Mbps (VBR)

[HE 1080/50.00i]; Average 5 Mbps (VBR)

[PM 720/50.00p]; Average 8 Mbps (VBR)

[SA 576/50.00i]

(When [ASPECT CONVERT] = [SIDE

CROP], [SQUEEZE]);

Average 9 Mbps (VBR)

Refer to page 162 and 224 for the picture size and recordable time of a motion picture.

Still picture recording:

Recording method;

JPEG corresponding DCF (Design rule for Camera File system, based on Exif 2.2 standard)

Refer to page 226 for picture size of a still picture and number of recordable pictures.

2 Slot function:

Relay, simultaneous, background*1, dual codec

*1 Available with a recording format of 50 Mbps or less

Digital video

Video signal for external output:

8 bit 4:2:2*2

*2 It is set to 8 bit 4:2:0 when UHD 59.94p or UHD 50.00p is selected.

Recording video signal:

8 bit 4:2:0

Video compression format:

MPEG-4 AVC/H.264 High Profile
(MOV/MP4/AVCHD)

Digital audio

Recording audio signal:

48 kHz/16 bit 2CH

Audio compression format:

Linear PCM (MOV/MP4), Dolby Digital
(AVCHD)

Headroom:

12 dB

Dual codec

Recording method:

MOV, MP4

Video compression format:

MPEG-4 AVC/H.264 High Profile

Audio compression format:

Linear PCM

Recording format:

When [DUAL CODEC REC] = [FHD 50Mbps]

- For main recording

[REC MODE] = [MOV]/[MP4]

[UHD 2160/29.97p 100M],

[UHD 2160/25.00p 100M],

[UHD 2160/23.98p 100M];

Average 100 Mbps (VBR)

- For sub recording

[REC MODE] = [MOV]/[MP4]*3

FHD 29.97p, 25.00p, 23.98p*4;

Average 50 Mbps (VBR)

When [DUAL CODEC REC] = [FHD 8Mbps]

- For main recording

[REC MODE] = [MOV]/[MP4]

[UHD 2160/29.97p 100M],

[UHD 2160/25.00p 100M],

[UHD 2160/23.98p 100M],

Average 100 Mbps (VBR)

[FHD 1080/59.94p

[FHD 1080/50.00p

[FHD 1080/29.97p

[FHD 1080/25.00p

[FHD 1080/23.98p

Average 200 Mbps (VBR)

[FHD 1080/59.94p 100M],

[FHD 1080/50.00p 100M];

Average 100 Mbps (VBR)

- For sub recording

[REC MODE] = [MOV]

FHD 59.94p, 50.00p, 29.97p, 25.00p,

23.98p*4;

Average 8 Mbps (VBR)

*3 It records motion picture with the same [REC MODE] setting selected for main recording.

*4 It records motion picture in the same frame rate as that of the [REC FORMAT] setting selected for main recording.

Video input/output

SDI OUT terminal:

BNC×1, 0.8 V [p-p], 75 Ω, 3G/1.5G HD-SDI,
SD-SDI compatible

Output format;

1080/59.94p LEVEL-A/50.00p LEVEL-A,

1080/29.97PsF/25.00PsF/24.00PsF/

23.98PsF, 1080/59.94i/50.00i,

720/59.94p/50.00p, 480/59.94i, 576/50.00i

AV OUT terminal:

AV terminal×1

HDMI OUT terminal:

HDMI×1,

(HDMI Type A, not compatible with
VIERA Link)

Output format;

2160/59.94p/50.00p/29.97p/25.00p/24.00p/

23.98p, 1080/59.94p/50.00p/29.97p/25.00p/

24.00p/23.98p/59.94i/50.00i, 720/59.94p/

50.00p, 480/59.94p, 576/50.00p

Audio input

Built-in microphone:

Supports stereo microphone

AUDIO INPUT1/AUDIO INPUT2 terminal:

XLR×2, 3-pin

Input high impedance, LINE/MIC/MIC+48 V (switch selection)

- LINE; +4 dBu/0 dBu (selectable menu)
- MIC; -40 dBu /-50 dBu /-60 dBu (selectable menu)

Audio output

SDI OUT terminal:

2ch (Linear PCM)

Gain settings; 0 dB/-6 dB/-12 dB (selectable menu)

HDMI OUT terminal:

2ch (Linear PCM)

AV OUT terminal:

3.5 mm diameter stereo mini jack×1

Output level; 251 mV

Output impedance; 600 Ω

Headphone output terminal:

3.5 mm diameter stereo mini jack×1

Speaker:

Round type speaker with a diameter of 20 mm ×1

Other input/output

CAM REMOTE terminal:

2.5 mm diameter super mini jack×1

(ZOOM, S/S)

3.5 mm diameter mini jack×1 (FOCUS, IRIS)

TC PRESET IN/OUT terminal:

BNC×1,

Used as the input and output terminals

- Input; 1.0 V to 4.0 V [p-p], 10 kΩ
- Output; 2.0 V ±0.5 V [p-p], low impedance

USB HOST terminal:

Type A connector, 9-pin

In Recording mode;

USB 2.0 compatible (5 V, 0.5 A)

In Playback mode;

USB 3.0 compatible (5 V, 0.9 A), used for external media device connection*5, bus power supported

- *5 External media device with a capacity of 32 GB or below or a capacity above 2 TB cannot be used

USB DEVICE terminal:

Type Micro B connector, 10-pin, USB 3.0 compatible, used for the mass storage function (read only)

DC input terminal:

DC 12 V (DC 11.4 V to 12.6 V), EIAJ type 4

Monitor

LCD monitor:

3.5-inch liquid crystal monitor

(Approx. 1150000 dots)

Viewfinder:

0.39-inch OLED (organic EL display)

(Approx. 2360000 dots, video display area;

Approx. 1770000 dots)

AC adaptor

Power source:

AC \sim 100 V to 240 V,
50 Hz/60 Hz, 1.2 A

Power output:

DC \equiv 12 V, 3.0 A

 indicates safety information

Ambient operating temperature:

0 °C to 40 °C

Ambient operating humidity:

10%RH to 90%RH (no condensation)

Mass:

Approx. 225 g

Dimensions (W×H×D):

115 mm×37 mm×57 mm

(Excluding the DC cord portion)

Battery charger

Input voltage:

DC \equiv 12 V, 3.0 A

Output voltage:

DC \equiv 8.4 V, 4.0 A

 indicates safety information

Charging current:

Max. 4000 mA

Ambient operating temperature:

0 °C to 40 °C

Ambient operating humidity:

10%RH to 80%RH (no condensation)

Mass:

Approx. 230 g

Dimensions (W×H×D):

130 mm×48 mm×107 mm

The symbols on this product (including the accessories) represent the following:

\sim	AC
\equiv	DC
	Class II equipment (The construction of the product is double-insulated.)

Декларація про Відповідність
Вимогам Технічного Регламенту Обмеження Використання деяких Небезпечних Речовин в
електричному та електронному обладнанні
(затвердженого Постановою №1057 Кабінету Міністрів України)

Виріб відповідає вимогам Технічного Регламенту Обмеження Використання деяких
Небезпечних Речовин в електричному та електронному обладнанні (ТР ОВНР).

Вміст небезпечних речовин у випадках, не обумовлених в Додатку №2 ТР ОВНР, :

- 1.свинець(Pb) – не перевищує 0,1 % ваги речовини або в концентрації до 1000 частин на мільйон;
- 2.кадмій (Cd)– не перевищує 0,01 % ваги речовини або в концентрації до 100 частин на мільйон;
- 3.ртуть(Hg) – не перевищує 0,1 % ваги речовини або в концентрації до 1000 частин на мільйон;
- 4.шестивалентний хром (Cr⁶⁺) – не перевищує 0,1 % ваги речовини або в концентрації до 1000 частин на мільйон;
- 5.полібромбіфеноли (PBB) – не перевищує 0,1 % ваги речовини або в концентрації до 1000 частин на мільйон;
- 6.полібромдефенілові ефіри (PBDE) – не перевищує 0,1 % ваги речовини або в концентрації до 1000 частин на мільйон.

EU



Manufactured by: Panasonic Corporation, Osaka, Japan
Importer's name and address of pursuant to EU rules:
Panasonic Marketing Europe GmbH
Panasonic Testing Centre
Winsbergring 15, 22525 Hamburg, Germany

Panasonic Corporation

Web site: <http://www.panasonic.com>

© Panasonic Corporation 2016