

datavideo

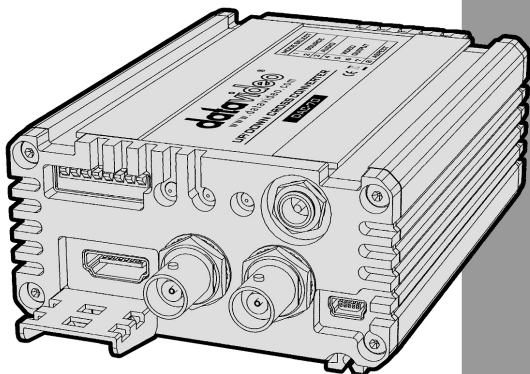

UP / DOWN / CROSS CONVERTER DAC-70

Instruction Manual

www.datavideo.com

Table of Contents

WARNINGS AND PRECAUTIONS	3
DISPOSAL	4
WARRANTY	4
STANDARD WARRANTY.....	4
TWO YEAR WARRANTY.....	5
PACKING LIST	5
INTRODUCTION	6
FEATURES	6
CONNECTIONS & CONTROLS	7
FRONT PANEL.....	7
REAR PANEL.....	8
DIP SWITCH MODE SELECTION	9
FIRMWARE UPDATE	11
DAC-70 CENTER UTILITY	12
DIMENSIONS	18
SPECIFICATIONS	19
SERVICE & SUPPORT	20

Disclaimer of Product and Services

The information offered in this instruction manual is intended as a guide only. At all times, Datavideo Technologies will try to give correct, complete and suitable information. However, Datavideo Technologies cannot exclude that some information in this manual, from time to time, may not be correct or may be incomplete. This manual may contain typing errors, omissions or incorrect information. Datavideo Technologies always recommend that you double check the information in this document for accuracy before making any purchase decision or using the product. Datavideo Technologies is not responsible for any omissions or errors, or for any subsequent loss or damage caused by using the information contained within this manual. Further advice on the content of this manual or on the product can be obtained by contacting your local Datavideo Office or dealer.



Warnings and Precautions

1. Read all of these warnings and save them for later reference.
2. Follow all warnings and instructions marked on this unit.
3. Unplug this unit from the wall outlet before cleaning. Do not use liquid or aerosol cleaners. Use a damp cloth for cleaning.
4. Do not use this unit in or near water.
5. Do not place this unit on an unstable cart, stand, or table. The unit may fall, causing serious damage.
6. Slots and openings on the cabinet top, back, and bottom are provided for ventilation. To ensure safe and reliable operation of this unit, and to protect it from overheating, do not block or cover these openings. Do not place this unit on a bed, sofa, rug, or similar surface, as the ventilation openings on the bottom of the cabinet will be blocked. This unit should never be placed near or over a heat register or radiator. This unit should not be placed in a built-in installation unless proper ventilation is provided.
7. This product should only be operated from the type of power source indicated on the marking label of the AC adapter. If you are not sure of the type of power available, consult your Datavideo dealer or your local power company.
8. Do not allow anything to rest on the power cord. Do not locate this unit where the power cord will be walked on, rolled over, or otherwise stressed.
9. If an extension cord must be used with this unit, make sure that the total of the ampere ratings on the products plugged into the extension cord do not exceed the extension cord's rating.
10. Make sure that the total amperes of all the units that are plugged into a single wall outlet do not exceed 15 amperes.
11. Never push objects of any kind into this unit through the cabinet ventilation slots, as they may touch dangerous voltage points or short out parts that could result in risk of fire or electric shock. Never spill liquid of any kind onto or into this unit.
12. Except as specifically explained elsewhere in this manual, do not attempt to service this product yourself. Opening or removing covers that are marked "Do Not Remove" may expose you to dangerous voltage points or other risks, and will void your warranty. Refer all service issues to qualified service personnel.
13. Unplug this product from the wall outlet and refer to qualified service personnel under the following conditions:

- a. When the power cord is damaged or frayed;
- b. When liquid has spilled into the unit;
- c. When the product has been exposed to rain or water;
- d. When the product does not operate normally under normal operating conditions. Adjust only those controls that are covered by the operating instructions in this manual; improper adjustment of other controls may result in damage to the unit and may often require extensive work by a qualified technician to restore the unit to normal operation;
- e. When the product has been dropped or the cabinet has been damaged;
- f. When the product exhibits a distinct change in performance, indicating a need for service.

Disposal



For EU Customers only - WEEE Marking

This symbol on the product indicates that it should not be treated as household waste. It must be handed over to the applicable take-back scheme for the recycling of Waste Electrical and Electronic Equipment. For more detailed information about the recycling of this product, please contact your local Datavideo office.

Warranty

Standard Warranty

- Datavideo equipment is guaranteed against any manufacturing defects for one year from the date of purchase.
- The original purchase invoice or other documentary evidence should be supplied at the time of any request for repair under warranty.
- Damage caused by accident, misuse, unauthorized repairs, sand, grit or water is not covered by this warranty.
- All mail or transportation costs including insurance are at the expense of the owner.
- All other claims of any nature are not covered.
- Cables & batteries are not covered under warranty.
- Warranty only valid within the country or region of purchase.
- Your statutory rights are not affected.

Two Year Warranty

All Datavideo products purchased after 01-Oct.-2008 qualify for a free one year extension to the standard Warranty, providing the product is registered with Datavideo within 30 days of purchase. For information on how to register please visit www.datavideo.com or contact your local Datavideo office or authorized Distributors

Certain parts with limited lifetime expectancy such as LCD Panels, DVD Drives and Hard Drives are only covered for the first 10,000 hours, or 1 year (whichever comes first).

Any second year warranty claims must be made to your local Datavideo office or one of its authorized Distributors before the extended warranty expires.

Packing List

Items	Description	Q'ty
1	DAC-70 Unit	1
2	Accessory List	1
3	Quick Start Guide	1

Introduction

The Datavideo DAC-70 is a broadcast quality up/down/cross converter. The unit allows the user to configure the device using a simple DIP switch or on a USB 2.0 interface utility. The DAC-70 case LEDs indicate the currently selected video source. The DAC-70 gives the user the capability of sharing VGA, HDMI or SDI inputs in an HDMI or SDI environment.

Housed in a metal case, the DAC-70 is tough enough to withstand the knocks of fast-paced live production setups in ENG or any studio. Built to the same dimensions as Datavideo's range of converters, the DAC-70 can also be mounted into a standard 19" RMK-2 rack with a mix of other units.

That's Datavideo, sharing the value!

Features

- 3G-SDI technology with full 10 bit processing and low SDI jitter
- DC or AC operation for convenient field or studio use
- DIP switch setup
- Micro USB 2.0 interface for firmware updates

Video Inputs - Choose from:

- HD / SD-SDI [BNC] with active SDI loop through
- HDMI
- VGA [15PIN D-Sub Female]

Audio Inputs

- HDMI / SDI embedded multi-channel audio
- Unbalanced RCA Phono sockets [Stereo L&R Channels @ line level]

Video outputs

- Two HD / SD-SDI [BNC] with embedded audio
- HDMI with embedded audio
- Simultaneous HDMI & SDI outputs regardless of settings

Control

- Windows only software utility for local configuration and control via Micro-USB 2.0 interface

Note: The DAC-70 supports HDCP copy protection, i.e. the DAC-70 outputs no signal when the user supplies protected DVD or BD video.

Connections & Controls

Front Panel

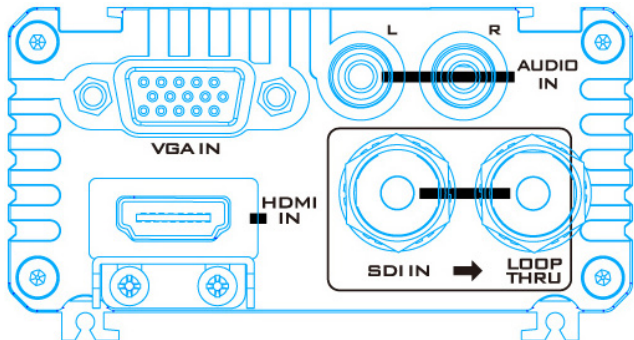

VGA IN

VGA IN connects the VGA equipment.

Supported Resolutions

800x600@60Hz, 1024x768 @60Hz, 1280x1024@60Hz,
1366x768@60Hz, 1400x1050@60Hz, 1600x1200@60Hz



HDMI IN

HDMI IN connects the HDMI equipment.

HDCP Copy Protection

For legal reasons, the HDMI input is unable to pass on video from copy protected HDMI sources.



Audio IN

Inputs for 2 channels of RCA unbalanced audio

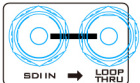

HD-SDI IN & Output (Loop Thru)

HD-SDI input and loop-through output connectors.

Rear Panel

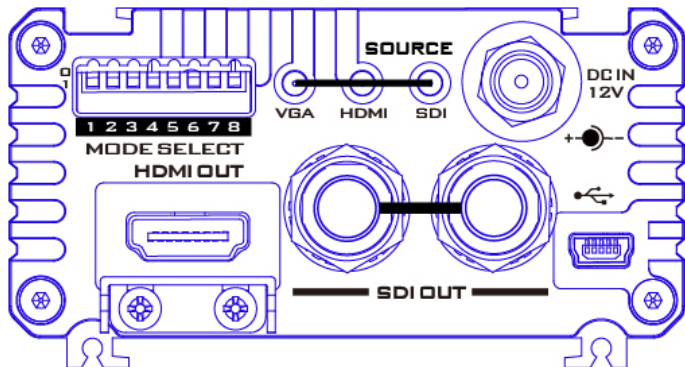

Mode Select (DIP switch)

Use the DIP switch to manually set the DAC-70 modes; please refer to the DIP Switch Mode Selection section (next page) for details.

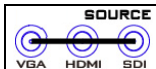

Source Indicator

Indicates video source format.



HDMI OUT

Video and Audio output from HDMI.

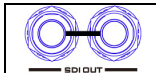

HD/SD - SDI OUT

Video and Audio output from SDI.



DC IN Socket

Connects the supplied 12V PSU to this socket. The connection can be secured by screwing the outer fastening ring of the DC IN plug to the socket.

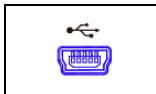

USB

The USB port connects the DAC-70 to the PC for [Firmware upgrade](#) and access to the [DAC-70 Center Utility](#)

DIP Switch Mode Selection

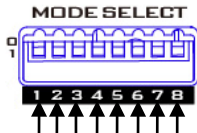

Source	Audio	Video Output	Ratio
00 VGA 01 HDMI 10 SDI 11 PC	0 INT. 1 EXT.	0000 1920x1080 p60 0001 1920x1080 p59.94 0010 1920x1080 p50 0011 1920x1080 p30 0100 1920x1080 p29.97 0101 1920x1080 p25 0110 1920x1080 p24 0111 1920x1080 p23.98	0 Full Screen 1 Pan Scan 16:9 / Keep Aspect Ratio (1:1) Select "Pan Scan 16:9" or "Keep Aspect Ratio" (1:1) on the DAC-70 Center Utility. Please refer to the next page for details.
DIP Switch is disabled when SOURCE is set to 11.		1000 1920x1080 i60 1001 1920x1080 i59.94 1010 1920x1080 i50 1011 1280x720 p60 1100 1280x720 p59.94 1101 1280x720 p50 1110 720x480 i59 (525i) 1111 720x570 i50 (625i)	

DIP Switch PIN 8

DOWN (0)	Full Screen
UP (1)	<p>Pan Scan 16:9 / Keep Aspect Ratio (1:1)</p> <p>On the MAIN page of the DAC-70 Center Utility, click the Setting tab to enter the page on which the user is allowed to select “Pan Scan 16:9” or “Keep Aspect Ratio” (1:1). Reboot the device after setting.</p> 

Pan Scan 16:9

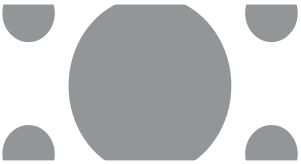
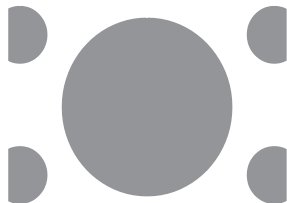
Input 4:3, output 16:9	Input 16:9, output 4:3
	

Firmware Update

From time to time Datavideo may release new firmware to either add new features or fix reported bugs in the current DAC-70 firmware. Customers can update the DAC-70 firmware themselves or contact their local dealer for assistance.

This section describes the firmware update process and it should take **approximately 10 minutes of total time to complete.**

Please note the current DAC-70 settings. The update process should not be interrupted once started as this could result in a non-responsive unit.

A working DAC-70 requires the following:

1. The latest firmware file for the DAC-70. This can be obtained from your local Datavideo dealer or office.
 2. The Upload Firmware utility. This can also be obtained from your local Datavideo dealer or office.
 3. A Windows PC with USB 2.0 port.
 4. A USB A to micro USB cable (USB 2.0).
-

How to update the DAC-70 firmware

1. Switch off the DAC-70 power.
2. Save the latest **firmware** file and the **Upload Firmware utility** to the PC desktop.



DataVideo Upload Firmware.exe
DataVideo Upload Firmware
Datavideo Technologies Co., Ltd

3. Use USB 2.0 cable to connect the DAC-70 to the computer.
4. Open the Datavideo Upload Firmware utility, which will show **Disconnected** and the connect button is greyed out.
5. Switch on the DAC-70 power and the connect button will now be enabled. Click the connect button and the Utility will show **Connected**.
6. Click the Open File button and select the new firmware file.
7. Click the Start button and wait for the progress bar to finish.
8. After the update is finished, the utility will show **PASS** to confirm that the unit has been updated successfully.
9. The utility will automatically disconnect the DAC-70 unit.
10. Unplug the USB cable from the DAC-70 and power cycle the unit.
11. The updated DAC-70 is now ready for use.

DAC-70 Center Utility

DAC-70 Center Utility is a Graphical User Interface that allows the user to obtain the device information and perform various video and audio settings. To use the utility, the user should first copy the **DAC-70 Center.exe** utility software from the installation CD to the computer running Windows. After that, connect the DAC-70 to the same computer using the USB cable. Switch on the DAC-70 and open the DAC-70 Center Utility software.

1. Click the **Information tab** to obtain the information on input format and firmware version.

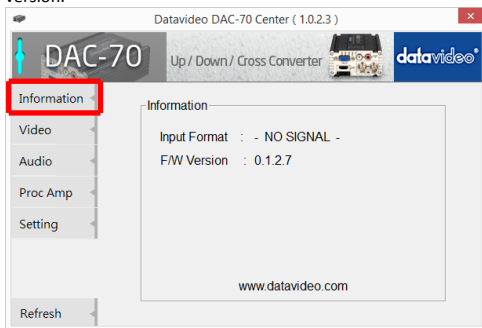

2. Click the **Video tab** to enter the video setup page.

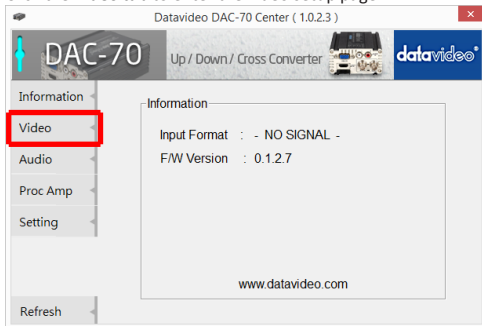

3. On the video setup page, click the **Video Setting** button to enter the video configuration page.

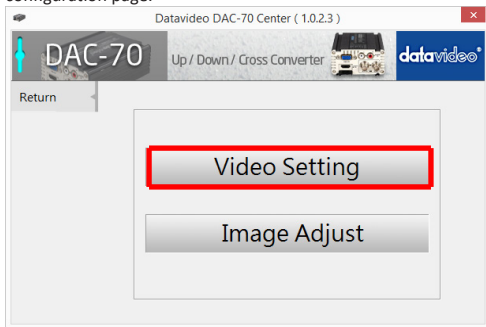

4. Set the input source, aspect ratio and output format.

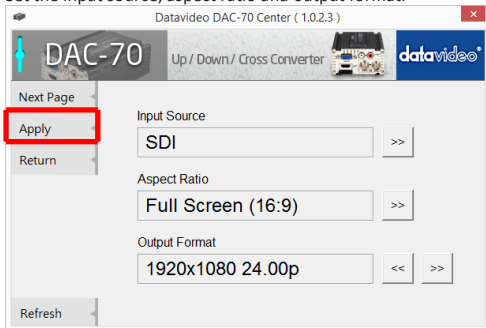

5. Click **Next Page** to set the HDMI Output Colour, HDMI Output Range and Edge Enhance; click **Apply** after all settings are configured.

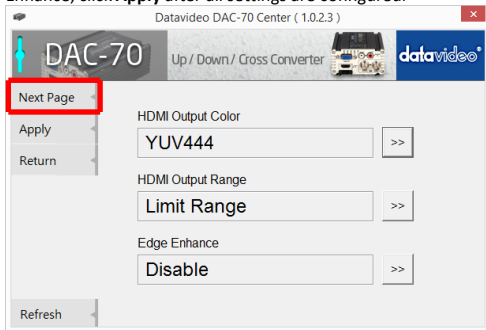

Note1: When **“Input Source”** is set to **“VGA”**, the user will be allowed to adjust **“Horizontal Position”** and **“Vertical Position”** under the **Image Adjust**.

Horizontal Position

Vertical Position

Note2: When **“Aspect Ratio”** is set to **“Under Scan”**, the user will be allowed to adjust **“Horizontal Size”** and **“Vertical Size”** under the **Image Adjust**.

Horizontal Size

Vertical Size

6. Click the **Audio tab** to set audio parameters

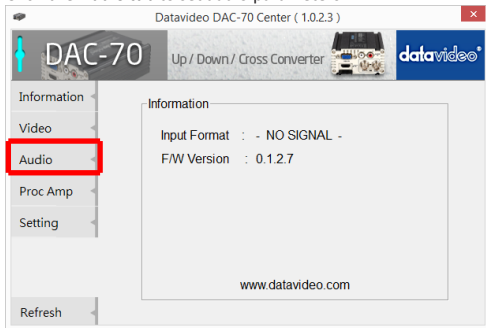

7. Click **Apply** after setting Audio Mute, Audio Source and Audio Level

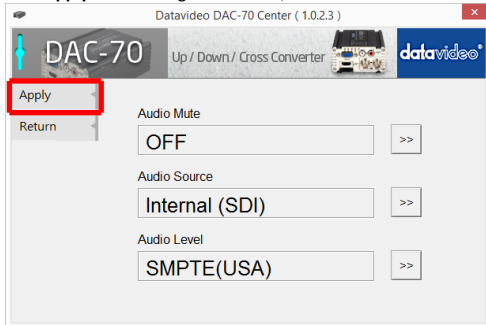

Note 1: Audio Level allows the user to select between EBU and SMPTE standards.

Note 2: Audio Level setting is enabled only for RCA input.

8. Click the **Proc AMP** tab to adjust the picture settings.

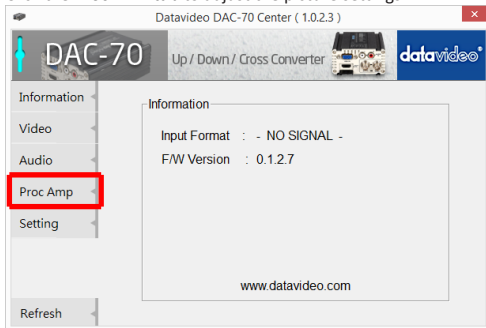

9. Set the **Brightness, Contrast, Hue, and Saturation** levels on the Proc Amp setup page.

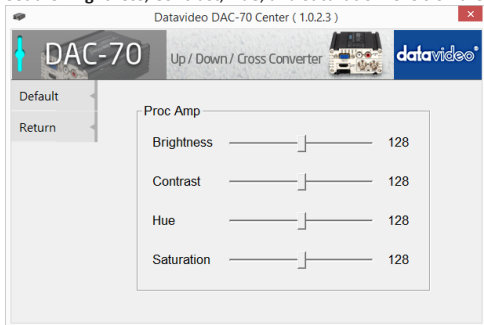

10. To restore the factory default settings, click the **Setting** tab.

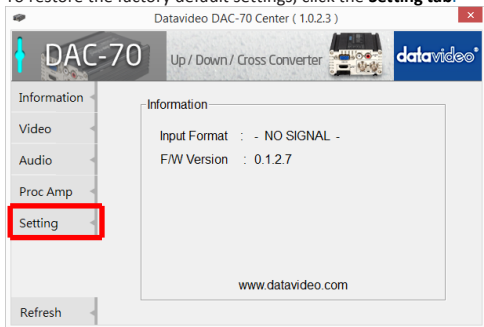

11. Click the Factory Default button to reset the DAC-70 to factory defaults. In addition, the user is also allowed to set **Dip Switch 8 (1) Mode**, **OSD Hide Mode** and **No Signal Mode**.

Dip Switch 8 (1) Mode	When 8 th bit of the DIP switch is set to 1, this menu allows the user to select Pan Scan 16:9 or Keep Aspect Ratio (1:1).
OSD Hide Mode	When enabled, source information and output resolution will not be displayed on the screen upon resolution change.
No Signal Mode	This sets how the screen looks like when there is no signal.

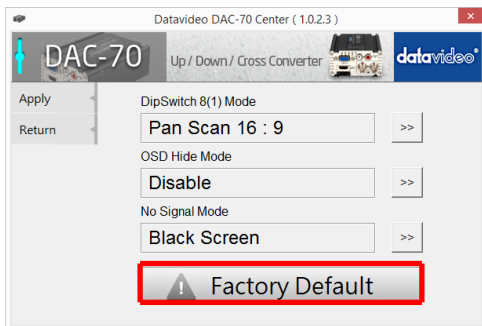

Dimensions

All measurements in mm

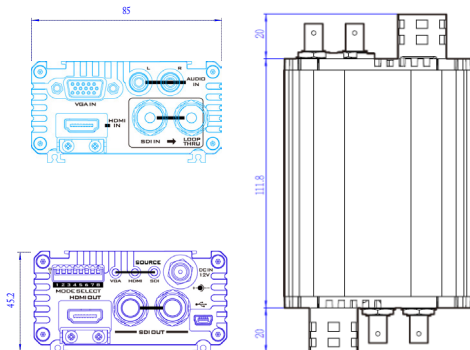

Specifications

Input	VGA x 1, HDMI x 1, HD/SD-SDI x 1, Analog Audio L/R
Output	SDI x 2, HDMI x 1, SDI Loop thru BNC (front panel)
Micro USB	<ul style="list-style-type: none"> ● Firmware upgrade ● Aspect ratio mode selection
Video Input Format	<ul style="list-style-type: none"> ● SDI (YUV) input 3G-SDI: 1080p60/50 1080p59.94 HD-SDI: 1080i60/50, 1080p30/25/24, 720p60/50 1080i59.94, 1080p29.97, 1080p23.98, 720p59.94 ● SD-SDI(YUV): 525i, 625i ● HDMI(YUV/RGB) 1080p60/50, 1080i60/50, 1080p30/25/24, 720p60/50 1080p59.94, 1080i59.94, 720p59.94, 1080p29.97 1080p23.98, 480p, 576p 800x600@60Hz, 1024x768@60Hz,1280x1024@60Hz 1366x768@60Hz, 1400x1050@60Hz, 1600x1200@60Hz ● VGA 800x600@60Hz, 1024x768@60Hz,1280x1024@60Hz 1366x768@60Hz, 1400x1050@60Hz, 1600x1200@60Hz ● HDMI Supports YUV / RGB color space
Video Output Format	<p>SDI / HDMI 1080p60/50, 1080p59.94, 1080p23.98/29.97/24/25/30 1080i60/50 ; 720P60/50 1080i59.94 ; 720P59.94, 525i, 625i</p> <ul style="list-style-type: none"> ● SDI/HDMI output supports YUV 4:2:2
Audio Format	<ul style="list-style-type: none"> ● Input Analog Audio L/R : stereo audio SDI / HDMI embedded audio up to 8CH, 48KHz, PCM audio HDMI embedded audio up to 8CH, 44.1/48/96KHz, PCM audio ● Output SDI embedded audio up to 8CH, 48KHz, PCM audio HDMI embedded audio up to 8CH, 48KHz, PCM audio
Power Consumption	Under 6W
Operating Temperature	0~50°C [32~114°F]
Storage Temperature	-10~ +60°C
Dimension	144.8mm(L) x 85mm(W) x 45.2mm(H)
Certifications	CE / FCC

Service & Support

It is our goal to make owning and using Datavideo products a satisfying experience. Our support staff is available to assist you to set up and operate your system. Contact your local office for specific support requests. Plus, please visit www.datavideo.com to access our FAQ section.

Datavideo Taiwan

Datavideo Technologies Co. Ltd
10F, No. 176, Jian 1st Rd., Chung Ho
District, New Taipei City 235, Taiwan,
R.O.C.
Tel: +886-2-8227-2888
Fax: +886-2-8227-2777
E-mail: service@datavideo.com.tw

Datavideo USA

Datavideo Corporation
7048 Elmer Avenue.
Whittier, CA 90602,
U.S.A.
Tel: +1-562-696 2324
Fax: +1-562-698 6930
E-mail: sales@datavideo.us

Datavideo Hong Kong

Datavideo Hong Kong Ltd
G/F., 26 Cross Lane
Wanchai, Hong Kong
Tel: +852-2833-1981
Fax: +852-2833-9916
E-mail: info@datavideo.com.hk

Datavideo Europe

Datavideo Technologies Europe BV
Floridadreef 106
3565 AM Utrecht,
The Netherlands
Tel: +31-30-261-96-56
Fax: +31-30-261-96-57
E-mail: info@datavideo.nl

Datavideo China

Datavideo Technologies China Co
101, NO. 618, LiuYing Rd, Zhabei District,
Shanghai, China
Tel: +86 21-5603 6599
Fax: +86 21-5603 6770
E-mail: service@datavideo.cn

Datavideo France

Datavideo France s.a.r.l
Cit  Descartes 1, rue Albert Einstein
Champs sur Marne
774477-Marne la Vall e cedex 2
Tel: +33-1-60370246
E-mail: info@datavideo.fr

Datavideo United Kingdom

Datavideo UK Limited
Units 1 & 2 Waterside Business Park
Hadfield, Glossop, Derbyshire
SK13 1BE, UK
Tel: +44-1457 851 000
Fax: +44-1457 850 964
E-mail: sales@datavideo.co.uk

Datavideo Singapore

Datavideo Technologies (S) PTE Ltd
No. 178 Paya Lebar Road #06-03
Singapore 409030
Tel: +65-6749 6866
Fax: +65-6749 3266
E-mail: sales@datavideo.sg

Datavideo India

Datavideo Technologies India Pvt L
A-132, Sec-63, Noida-201307,
Uttar Pradesh (UP), India.
Tel: +91-0120-2427337
Fax: +91-0120-2427338
E-mail: sales@datavideo.in

datavideo
www.datavideo.com

All the trademarks are the properties of their respective owners.
Datavideo Technologies Co., Ltd. All rights reserved 2013

Apr-23, 2015 P/N: G082060577E5