

**data**video

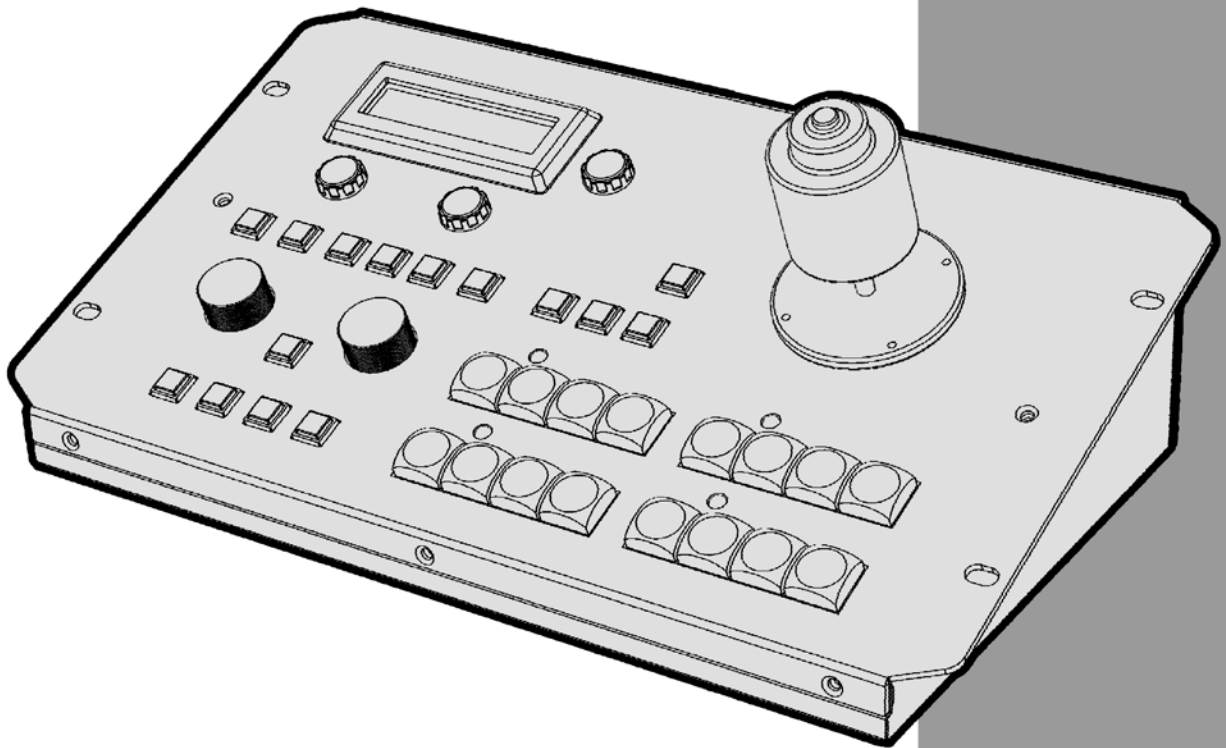

**PTZ CAMERA  
CONTROL UNIT  
RMC-180**

**Instruction manual**

[www.datavideo.com](http://www.datavideo.com)

## Table of Contents

<b>WARNINGS AND PRECAUTIONS .....</b>	<b>3</b>
<b>WARRANTY .....</b>	<b>4</b>
STANDARD WARRANTY .....	4
TWO YEAR WARRANTY .....	4
<b>DISPOSAL.....</b>	<b>4</b>
<b>PACKING LIST.....</b>	<b>4</b>
<b>INTRODUCTION .....</b>	<b>5</b>
FEATURES .....	5
COMPATIBLE CONTROL STANDARDS.....	5
<b>CONNECTIONS AND CONTROLS.....</b>	<b>6</b>
FRONT PANEL – KEYBOARD.....	6
REAR PANEL - CONNECTIONS .....	8
<b>MENU SETUP .....</b>	<b>9</b>
<b>STORING DIFFERENT CAMERA POSITIONS.....</b>	<b>10</b>
<b>TALLY INPUT CONNECTOR.....</b>	<b>11</b>
<b>FIRMWARE UPGRADE PROCEDURE .....</b>	<b>12</b>
<b>DIMENSIONS .....</b>	<b>15</b>
<b>SERVICE AND SUPPORT .....</b>	<b>16</b>

### Disclaimer of Product and Services

The information offered in this instruction manual is intended as a guide only. At all times, Datavideo Technologies will try to give correct, complete and suitable information. However, Datavideo Technologies cannot exclude that some information in this manual, from time to time, may not be correct or may be incomplete. This manual may contain typing errors, omissions or incorrect information. Datavideo Technologies always recommend that you double check the information in this document for accuracy before making any purchase decision or using the product. Datavideo Technologies is not responsible for any omissions or errors, or for any subsequent loss or damage caused by using the information contained within this manual. Further advice on the content of this manual or on the product can be obtained by contacting your local Datavideo Office or dealer.

## Warnings and Precautions



1. Read all of these warnings and save them for later reference.
2. Follow all warnings and instructions marked on this unit.
3. Unplug this unit from the wall outlet before cleaning. Do not use liquid or aerosol cleaners. Use a damp cloth for cleaning.
4. Do not use this unit in or near water.
5. Do not place this unit on an unstable cart, stand, or table. The unit may fall, causing serious damage.
6. Slots and openings on the cabinet top, back, and bottom are provided for ventilation. To ensure safe and reliable operation of this unit, and to protect it from overheating, do not block or cover these openings. Do not place this unit on a bed, sofa, rug, or similar surface, as the ventilation openings on the bottom of the cabinet will be blocked. This unit should never be placed near or over a heat register or radiator. This unit should not be placed in a built-in installation unless proper ventilation is provided.
7. This product should only be operated from the type of power source indicated on the marking label of the AC adapter. If you are not sure of the type of power available, consult your Datavideo dealer or your local power company.
8. Do not allow anything to rest on the power cord. Do not locate this unit where the power cord will be walked on, rolled over, or otherwise stressed.
9. If an extension cord must be used with this unit, make sure that the total of the ampere ratings on the products plugged into the extension cord do not exceed the extension cord rating.
10. Make sure that the total amperes of all the units that are plugged into a single wall outlet do not exceed 15 amperes.
11. Never push objects of any kind into this unit through the cabinet ventilation slots, as they may touch dangerous voltage points or short out parts that could result in risk of fire or electric shock. Never spill liquid of any kind onto or into this unit.
12. Except as specifically explained elsewhere in this manual, do not attempt to service this product yourself. Opening or removing covers that are marked "Do Not Remove" may expose you to dangerous voltage points or other risks, and will void your warranty. Refer all service issues to qualified service personnel.
13. Unplug this product from the wall outlet and refer to qualified service personnel under the following conditions:
  - a. When the power cord is damaged or frayed;
  - b. When liquid has spilled into the unit;
  - c. When the product has been exposed to rain or water;
  - d. When the product does not operate normally under normal operating conditions. Adjust only those controls that are covered by the operating instructions in this manual; improper adjustment of other controls may result in damage to the unit and may often require extensive work by a qualified technician to restore the unit to normal operation;
  - e. When the product has been dropped or the cabinet has been damaged;
  - f. When the product exhibits a distinct change in performance, indicating a need for service.

## Warranty

### Standard Warranty

- Datavideo equipment is guaranteed against any manufacturing defects for one year from the date of purchase.
- The original purchase invoice or other documentary evidence should be supplied at the time of any request for repair under warranty.
- Damage caused by accident, misuse, unauthorized repairs, sand, grit or water is not covered by this warranty.
- All mail or transportation costs including insurance are at the expense of the owner.
- All other claims of any nature are not covered.
- Cables & batteries are not covered under warranty.
- Warranty only valid within the country or region of purchase.
- Your statutory rights are not affected.

### Two Year Warranty

- All Datavideo products purchased after 01-Oct.-2008 qualify for a free one year extension to the standard Warranty, providing the product is registered with Datavideo within 30 days of purchase. For information on how to register please visit [www.datavideo.com](http://www.datavideo.com) or contact your local Datavideo office or authorized Distributors
- Certain parts with limited lifetime expectancy such as LCD Panels, DVD Drives, Hard Drives are only covered for the first 10,000 hours, or 1 year (whichever comes first).

Any second year warranty claims must be made to your local Datavideo office or one of its authorized Distributors before the extended warranty expires.

## Disposal



### For EU Customers only - WEEE Marking.

This symbol on the product indicates that it should not be treated as household waste. It must be handed over to an applicable take-back scheme for the recycling of Waste Electrical and Electronic Equipment. For more detailed information about the recycling of this product, please contact your local Datavideo office or your local recycling centre.

## Packing List

The following items should be included in the box. If any items are missing please contact your supplier.

Item No.	Description	Quantity
1	RMC-180 CCU Control Box	1
2	Accessory kit *	1
3	Instruction Manual	1

*\*The accessory kit also contains a packing list.*

## Introduction

The Datavideo RMC-180 Controller is capable of controlling up to 4 Datavideo Pan Tilt Zoom (PTZ) cameras such as the PTC-150.

To get more value out of your equipment, please take a few minutes to read this manual thoroughly. This will help you to familiarise yourself with all aspects of the RMC-180 CCU Controller unit.

*That's Datavideo; sharing the value!*

### Features

- Remote control of up to four Pan,Tilt and Zoom cameras
- Pan,Tilt and Zoom with speed control by joystick
- Control of Pan, Tilt and Zoom as well as Iris, Focus, Gain, and other functions over Ethernet
- Multiple presets for PTZ settings for each individual camera
- Full remote control of each camera via serial communication over affordable network cabling
- Compatible with Datavideo's switcher tally indicators
- Compact design for easy installation
- Easy integration with Datavideo HD switchers for an affordable multi-camera solution.

### Compatible Control Standards

Depending on your chosen PTZ camera(s) the following control standards are available.

- SONY VISCA

**Please note** that a firmware update may be required to switch your RMC-180 to the same protocol as the camera you wish to control. All units are initially supplied with the VISCA protocol as this works with the Datavideo PTC-150 camera.

## Connections and Controls

### Front Panel – Keyboard

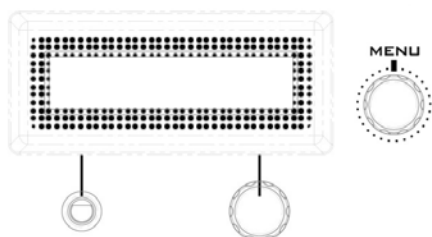
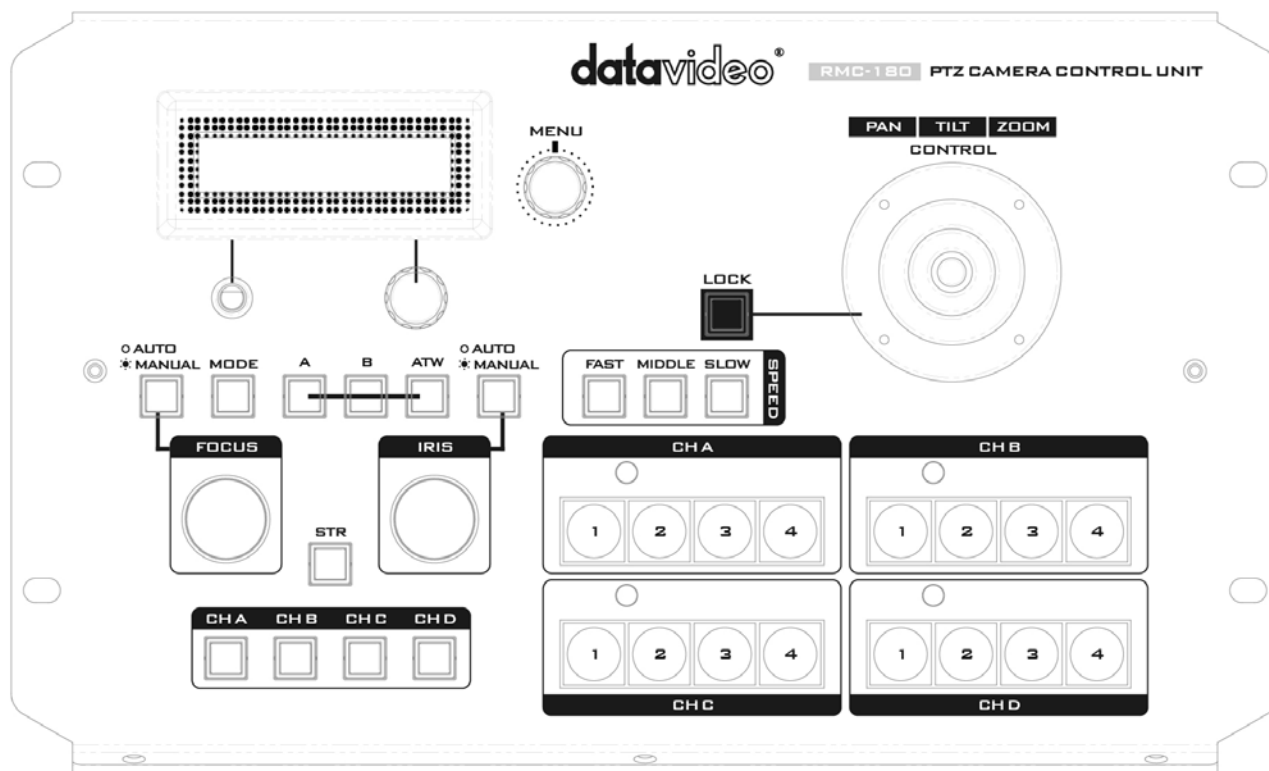

#### LCD Display

The RMC-180 status or the setup menu options are displayed on the LCD panel.

#### Menu Control Dials

The RMC-180 configuration menu can be entered and changed using these dials.



#### FOCUS

To manually control focus adjustment, first press the AUTO/MANUAL button so it is illuminated or ON.

The FOCUS dial can then be turned to achieve the desired focus.

If the AUTO/MANUAL button is not illuminated or OFF, then the camera will use its own Auto Focus feature if this function is available.

#### Mode Select



**MODE** The selected PTC-150 camera will output colour bars. Press again to return to the PTC-150 camera view

**A** Push Auto

**B** Manual

**ATW** Force Automatic White Balance

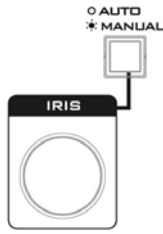

### IRIS

To manually control Iris adjustment, first press the AUTO/MANUAL button so it is illuminated or ON.

The IRIS dial can then be turned to achieve the desired exposure.

If the AUTO/MANUAL button is not illuminated or OFF, then the camera will use its own Auto Iris feature if this function is available.



### Channel A, B, C, D buttons

To control or set up a connected camera, first select it using these buttons. The selected camera button will be illuminated or ON.

### PTZ Joystick Control

Before attempting to use the joystick to PAN, TILT or ZOOM a selected camera, first unlock the joystick by pressing the LOCK button.

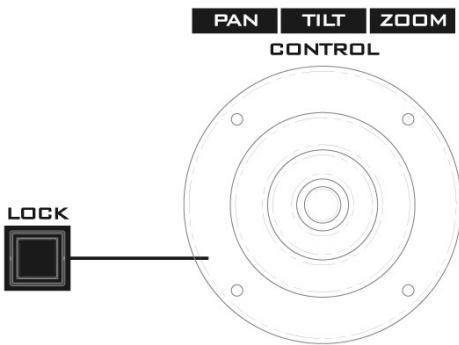

**PAN** – Move the joystick horizontally to the left or right to pan the selected PTZ camera head from left to right or vice versa.

**TILT** – Move the joystick up or down to tilt the selected camera head up or down.

**ZOOM** – Twist the joystick clockwise (to the right) or anti-clockwise (to the left) to have the selected camera zoom in or out.

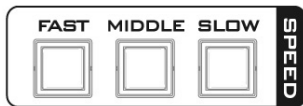

### Speed

The speed at which the selected camera moves can be chosen by pressing one of three speed buttons.



### STR

Pressing this button enters the RMC-180 into STORE MODE. When activated, this allows the current camera position to be stored in a chosen Channel Memory Button.

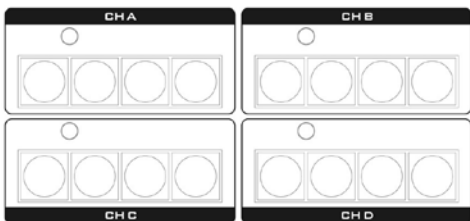

### Channel Memory Buttons

These buttons may be used to store up to four camera positions for each camera. Each button corresponds to one camera and one stored position. The activated button for each camera is illuminated.

### Tally Indicator LEDs

Each above set of four memory buttons is assigned a Tally Indicator LED. This LED feature becomes active when the RMC-180 is connected to the tally output of a compatible Datavideo Switcher such as the HS-2000 or HS-2200.

When the HS-2000 or HS-2200 Switcher is sending camera A's video to the program output, the CH A's tally LED will be illuminated on the RMC-180. Additional equipment and cabling are required.

## Rear Panel - Connections

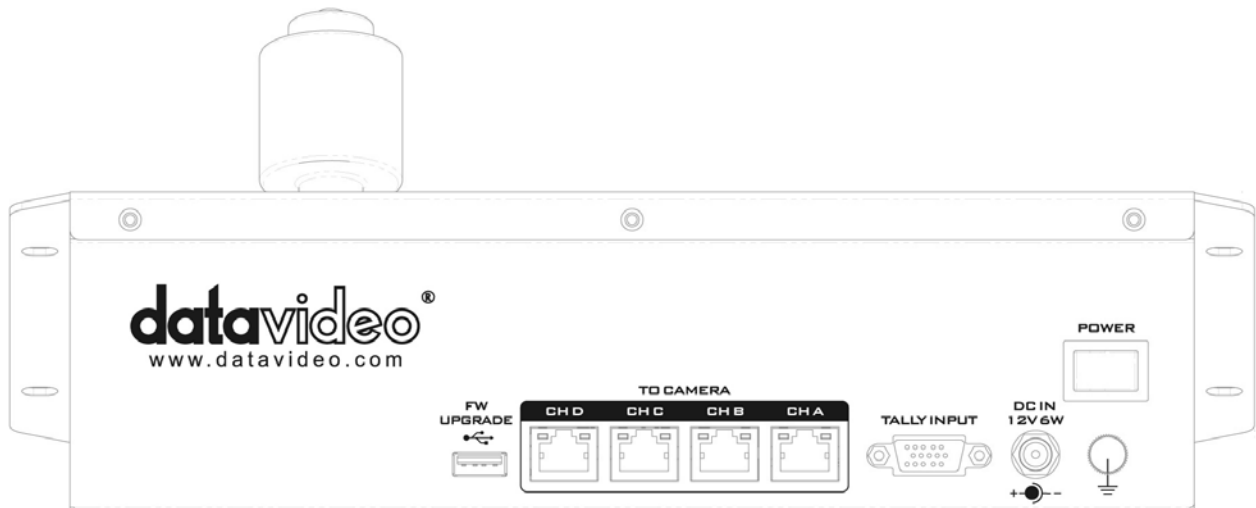

### Firmware Upgrade

USB type A port, for connection to a computer during the firmware upgrade process.

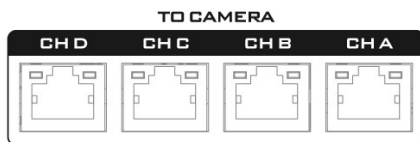

### RJ-45 ports to connect cameras A, B, C & D

Four RJ-45 ports are provided on the RMC-180 rear to connect PTZ cameras.

**NB:** Max allowable cable length is **300 m**.



### Tally Input

The RMC-180 has the ability to receive tally signals from Datavideo Switchers such as the HS-2000 or HS-2200. Using the video switcher's tally output signals, the RMC-180 can turn on an LED on the keyboard, giving the camera operator an indication of which camera is currently live at the switcher end.



### DC In Socket

Connect the supplied 12V 0.5A PSU to this socket. The connection can be secured by screwing the outer fastening ring of the DC In plug to the socket. The connection is centre positive.



### Power On/Off Switch

Switches the unit On / Off.



### Grounding Terminal

When connecting this unit to any other component, make sure that it is properly grounded by connecting this terminal to an appropriate point. When connecting, use the socket and be sure to use wire with a cross-sectional area of at least 1.0 mm<sup>2</sup>.



## Menu Setup

### 1. POWER CONTROL

Camera power ON / OFF

### 2. WHITE BALANCE STR

Save white balance setting of mode A or B.

(Please select the mode (A or B) before you adjust the white balance)

### 3. SHUTTER SET

Camera shutter mode selection

### 4. VOUT FORMAT SELECT

Video output format selection

### 5. PAN DIRECTION SET

Set the camera pan direction to normal or reversed (LEFT/RIGHT).

### 6. TILT DIRECTION SET

Set the camera tilt direction to normal or reversed (UP/DOWN).

### 7. ZOOM DIRECTION

Set the camera zoom direction to normal or reversed (ZOOM IN/OUT).



Turn the joystick left to zoom in or right to zoom out.

### 8. FOCUS DIRECTION SET

Set the camera focus direction to normal or reversed (LEFT/RIGHT).

- Step 1 - Push **the Auto/Manual** button, and the button LED will be turned on.
- Step 2 - Push **FOCUS Knob**, the **Auto/Manual** button will start flashing.
- Step 3 - Push **Auto/Manual** button to select the FOCUS control speed.
- Step 4 - Push and turn the **FOCUS Knob** to adjust the camera focus.

### 9. IRIS DIRECTION SET

Set the camera iris direction to normal or reversed (LEFT/RIGHT).

- Step 1 - Push **the Auto/Manual** button, and the button LED will be turned on.
- Step 2 – Push the **IRIS Knob**, the **Auto/Manual** button will start flashing.
- Step 3 – Push the **Auto Manual** button to select IRIS control speed.

- Step 4 - Push and turn the **IRIS Knob** to adjust the camera iris.

## 10. JOYSTICK SENSITIVITY

Joystick control sensitivity adjustment

## 11. RMC-180 FW VERSION

Displays the RMC-180 firmware version

## 12. EXIT

Exit the setup menu mode.

## Storing Different Camera Positions

The RMC-180 allows you to store up to four camera positions for each of the four possible cameras, CH A, B, C and D. This means, with four PTZ cameras connected to the RMC-180, up to sixteen camera positions can be stored.

**NB:** The position and settings are stored in the camera and not in the RMC-180.

To store a cameras position:

1. Select the camera that you wish to use: CH A / CH B / CH C / CH D



2. Adjust the camera lens to the desired position or view using the joystick. Set the focus, Iris and zoom to the desired camera video output.
3. Push the STR (store) button and it will be illuminated.



4. The corresponding four memory buttons of the selected camera will be illuminated and to save the current position, auto-focus and PTZ settings, simply press a memory button

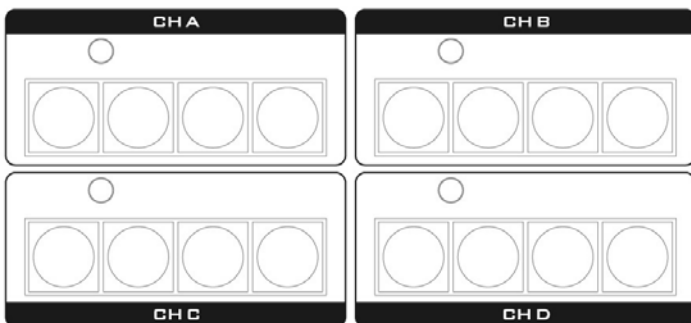

5. The pressed memory button will remain illuminated for 2 seconds and the button LED will be turned off after the settings are successfully saved.

## Tally Input Connector

### Pin Assignment

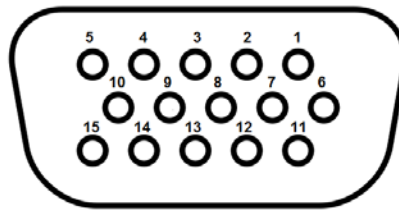

D-Sub 15-PIN Female

The pin assignment of the Tally Input Connector is shown in the following table:

Channel	CH 1	CH 2	CH 3	CH 4
PGM Tally	Pin 1	Pin 6	Pin 11	Pin 5
PVW Tally	Pin 3	Pin 8	Pin 13	Pin 15
GND	Pins 4, 9, 14			

## Firmware Upgrade Procedure

From time to time, Datavideo may release new firmware to either add new features or to fix reported bugs in the current RMC-180 firmware. Customers can update the firmware themselves if they wish or they can contact their local dealer or reseller for assistance should they prefer this method.

This section describes the firmware update process and it should take **approximately 30 minutes to complete**. Once started, **the update process should not be interrupted in any way** as this could result in a non-responsive unit.

### Requirement

- Latest firmware update files (bootloader and application firmware)
- A USB A to USB A cable not longer than 2 meters
- A Windows PC with USB 2.0 ports

1. Power off the RMC-180 and connect the USB A cable between the USB firmware upgrade port



on the RMC-180 rear panel and a USB port on the computer

2. Press and hold the four buttons indicated with  at the same time

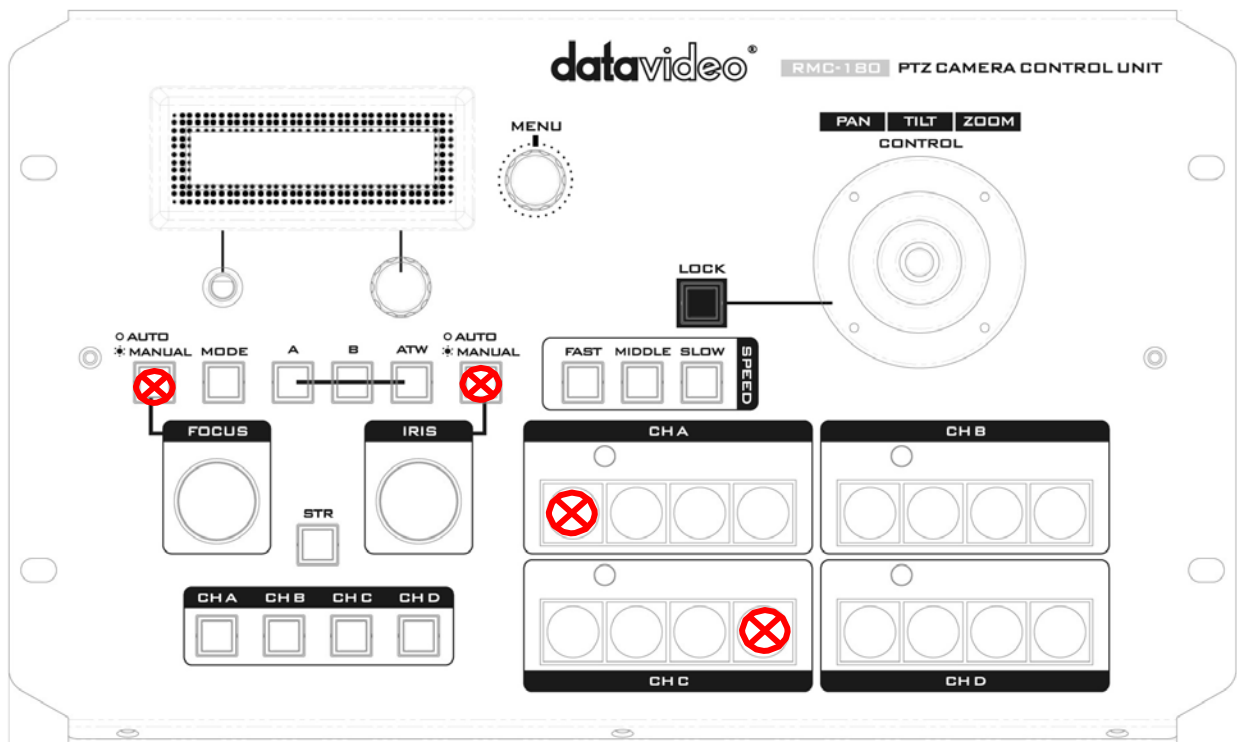

3. Another person switches on the RMC-180 device while one person presses and holds the buttons indicated with 

4. The user may release the buttons once the RMC-180 LCD displays the following information.

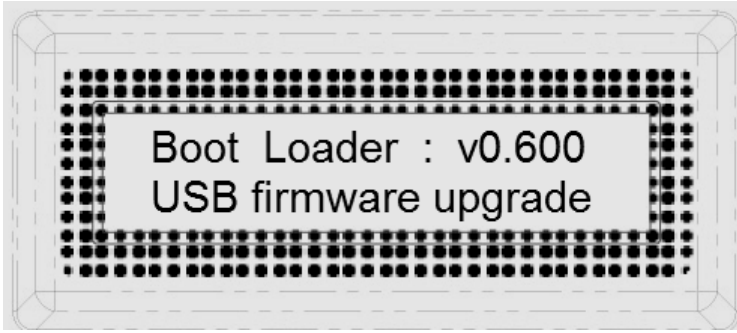

5. The RMC-180 device (**RMC-180\_U38**) will appear as a removable storage device on the PC as shown below.

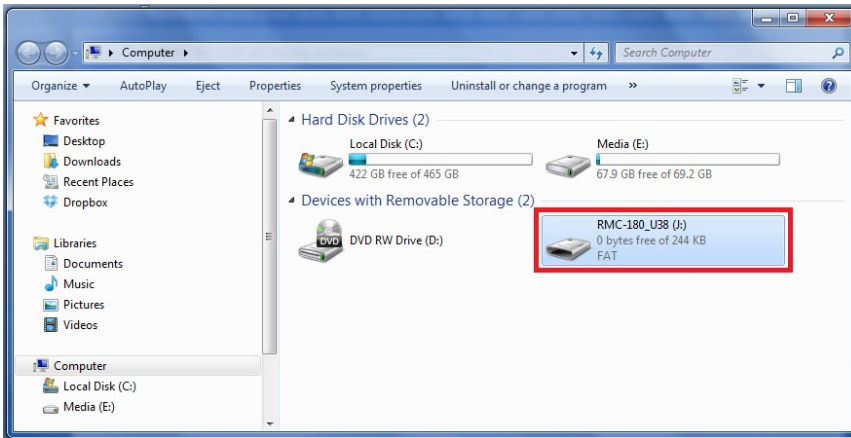

6. Double click on the RMC-180\_U38 removable storage device and delete the "bootcode.bin" file
7. Copy and paste the latest firmware file (bootcode.bin) into the RMC-180\_U38 removable storage device
8. Reboot the RMC-180 device until the LCD displays the following

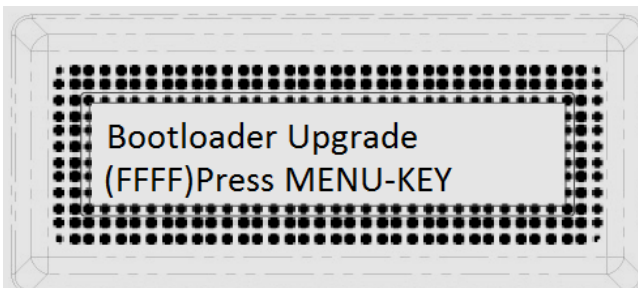

9. Press the MENU key to start the firmware upgrade and do not disconnect the power before the upgrade is complete

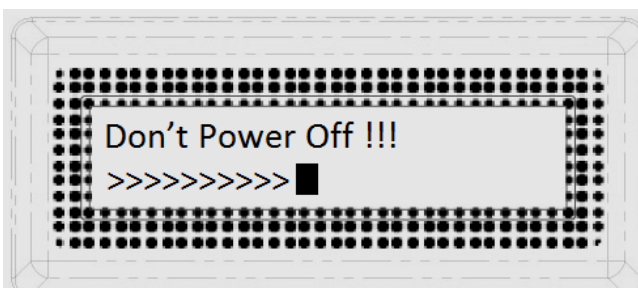

10. After the bootloader firmware upgrade is complete, the LCD display will show the following and the user may proceed to upgrading the application firmware.

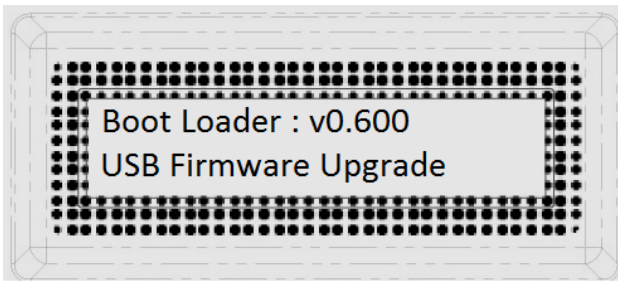

11. Remove bootcode.bin from the RMC-180 device and copy and paste the application firmware into the RMC-180 device

Name	Date modified	Type	Size
 RMC180_PTC150_1v002	2015/5/14 下午 0...	BIN 文件	76 KB

12. Reboot the RMC-180 device again and the LCD display will now show the following.

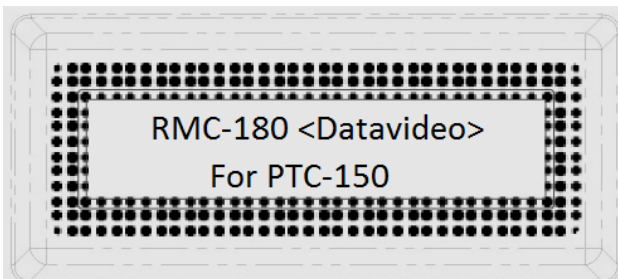

13. The RMC-180 device is now ready for controlling the connected cameras.

# Dimensions

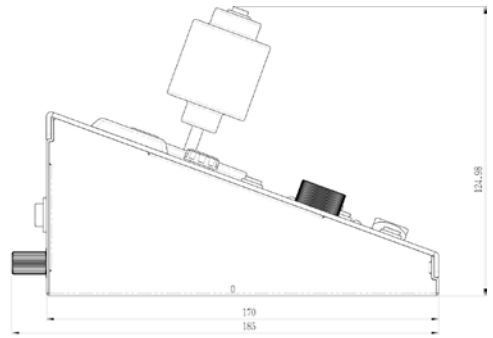
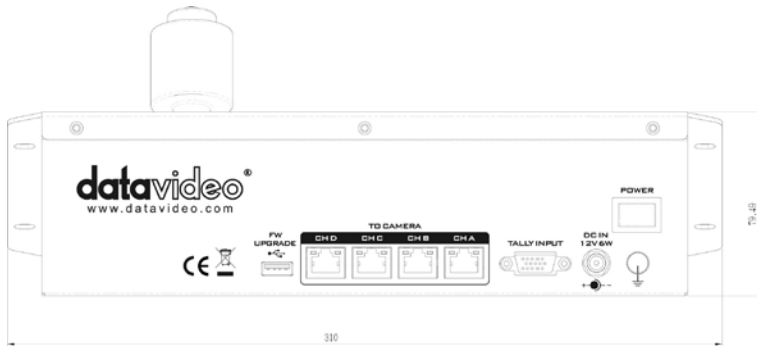

# Service & Support

It is our goal to make owning and using Datavideo products a satisfying experience. Our support staff is available to assist you to set up and operate your system. Contact your local office for specific support requests. Plus, please visit [www.datavideo.com](http://www.datavideo.com) to access our FAQ section.

## Datavideo Taiwan

Datavideo Technologies Co. Ltd  
10F. No. 176, Jian 1st Rd., Chung Ho  
District, New Taipei City 235, Taiwan,  
R.O.C.  
Tel: +886-2-8227-2888  
Fax: +886-2-8227-2777  
E-mail: [service@datavideo.com.tw](mailto:service@datavideo.com.tw)

## Datavideo Europe

Datavideo Technologies Europe BV  
Floridadreef 106  
3565 AM Utrecht,  
The Netherlands  
Tel: +31-30-261-96-56  
Fax: +31-30-261-96-57  
E-mail: [info@datavideo.nl](mailto:info@datavideo.nl)

## Datavideo United Kingdom

Datavideo UK Limited  
Units 1 & 2 Waterside Business Park  
Hadfield, Glossop, Derbyshire  
SK13 1BE, UK  
Tel: +44-1457 851 000  
Fax: +44-1457 850 964  
E-mail: [sales@datavideo.co.uk](mailto:sales@datavideo.co.uk)

## Datavideo USA

Datavideo Corporation  
7048 Elmer Avenue.  
Whittier, CA 90602,  
U.S.A.  
Tel: +1-562-696 2324  
Fax: +1-562-698 6930  
E-mail: [sales@datavideo.us](mailto:sales@datavideo.us)

## Datavideo China

Datavideo Technologies China Co  
101, NO. 618, LiuYing Rd, Zhabei District,  
Shanghai, China  
Tel: +86 21-5603 6599  
Fax: +86 21-5603 6770  
E-mail: [service@datavideo.cn](mailto:service@datavideo.cn)

## Datavideo Singapore

Datavideo Technologies (S) PTE Ltd  
No. 178 Paya Lebar Road #06-03  
Singapore 409030  
Tel: +65-6749 6866  
Fax: +65-6749 3266  
E-mail: [sales@datavideo.sg](mailto:sales@datavideo.sg)

## Datavideo Hong Kong

Datavideo Hong Kong Ltd  
G/F., 26 Cross Lane  
Wanchai, Hong Kong  
Tel: +852-2833-1981  
Fax: +852-2833-9916  
E-mail: [info@datavideo.com.hk](mailto:info@datavideo.com.hk)

## Datavideo France

Datavideo France s.a.r.l  
Cité Descartes 1, rue Albert Einstein  
Champs sur Marne  
774477-Marne la Vallée cedex 2  
Tel: +33-1-60370246  
E-mail: [info@datavideo.fr](mailto:info@datavideo.fr)

## Datavideo India

Datavideo Technologies India Pvt Ltd  
A-132, Sec-63, Noida-201307,  
Uttar Pradesh (UP), India.  
Tel: +91-0120-2427337  
Fax: +91-0120-2427338  
E-mail: [sales@datavideo.in](mailto:sales@datavideo.in)



Please refer to our website for update the latest version manual.  
[www.datavideo.com/PTZ+Camera+and+Control/RMC-180](http://www.datavideo.com/PTZ+Camera+and+Control/RMC-180)

**datavideo**  
[www.datavideo.com](http://www.datavideo.com)