



KRAMER ELECTRONICS LTD.

USER MANUAL

MODEL:

VM-50AN
1:5 Audio Distributor

P/N: 2900-000050 Rev 3



VM-50AN Quick Start Guide

This guide helps you install and use your product for the first time. For more detailed information, go to http://www.kramerelectronics.com/support/product_downloads.asp to download the latest manual or scan the QR code on the left.

Step 1: Check what's in the box

- VM-50AN 1:5 Audio Distributor
- 4 Rubber feet
- 1 Power supply (12V DC)
- 1 Quick Start sheet

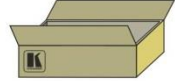

Save the original box and packaging materials in case you need to return your VM-50AN for service.

Step 2: Install the VM-50AN

Attach the rubber feet and place on a table or mount the VM-50AN in a rack (using an optional RK-1 rack mount).

Step 3: Connect the inputs and outputs

Always switch off the power on each device before connecting it to your VM-50AN.

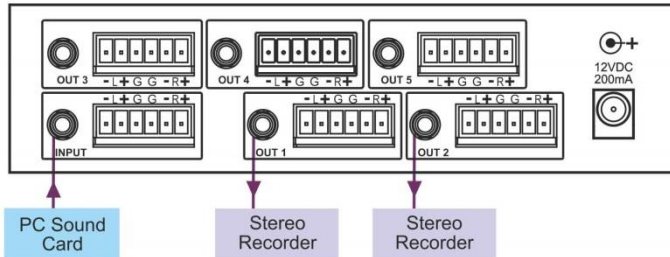

Always use Kramer high-performance cables for connecting AV equipment to the VM-50AN.

Step 4: Connect the power

Connect the 12V DC power adapter to the VM-50AN and plug the adapter into the mains electricity.



Step 5: Operate the VM-50AN

Set the input mode to balanced or unbalanced stereo. Using a small screwdriver, adjust the output level.

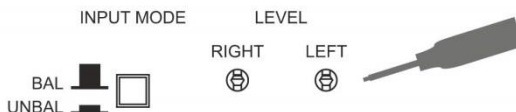

Contents

1	Introduction	1
2	Getting Started	2
2.1	Achieving the Best Performance	2
2.2	Safety Instructions	3
2.3	Recycling Kramer Products	3
3	Overview	4
3.1	Defining the VM-50AN 1:5 Audio Distributor	4
4	Using Your VM-50AN 1:5 Audio Distributor	6
4.1	Connecting the VM-50AN as a Balanced Stereo 1:5 Audio Distributor	6
4.2	Connecting the VM-50AN as an Unbalanced Stereo 1:5 Audio Distributor	7
4.3	Connecting the VM-50AN as a 1:10 Audio Distributor	8
5	Technical Specifications	10

Figures

Figure 1:	VM-50AN 1:5 Audio Distributor	4
Figure 2:	Connecting the VM-50AN as a Balanced Stereo 1:5 Audio Distributor	7
Figure 3:	Connecting the VM-50AN as an Unbalanced Stereo 1:5 Audio Distributor	8
Figure 4:	Connecting the VM-50AN as a 1:10 Audio Distributor	9

1 Introduction

Welcome to Kramer Electronics! Since 1981, Kramer Electronics has been providing a world of unique, creative, and affordable solutions to the vast range of problems that confront video, audio, presentation, and broadcasting professionals on a daily basis. In recent years, we have redesigned and upgraded most of our line, making the best even better!

Our 1,000-plus different models now appear in 11 groups that are clearly defined by function: GROUP 1: Distribution Amplifiers; GROUP 2: Switchers and Routers; GROUP 3: Control Systems; GROUP 4: Format/Standards Converters; GROUP 5: Range Extenders and Repeaters; GROUP 6: Specialty AV Products; GROUP 7: Scan Converters and Scalers; GROUP 8: Cables and Connectors; GROUP 9: Room Connectivity; GROUP 10: Accessories and Rack Adapters and GROUP 11: Sierra Products.

Congratulations on purchasing your Kramer **VM-50AN** *1:5 Audio Distributor*, which is ideal for the following typical applications:

- Video/audio duplication studios and retail outlets
- Any audio system requiring multiple outputs from a single source

2 Getting Started

We recommend that you:

- Unpack the equipment carefully and save the original box and packaging materials for possible future shipment
- Review the contents of this user manual



Go to http://www.kramerelectronics.com/support/product_downloads.asp to check for up-to-date user manuals, application programs, and to check if firmware upgrades are available (where appropriate).

2.1 Achieving the Best Performance

To achieve the best performance:

- Use only good quality connection cables (we recommend Kramer high-performance, high-resolution cables) to avoid interference, deterioration in signal quality due to poor matching, and elevated noise levels (often associated with low quality cables)
- Do not secure the cables in tight bundles or roll the slack into tight coils
- Avoid interference from neighboring electrical appliances that may adversely influence signal quality
- Position your Kramer **VM-50AN** away from moisture, excessive sunlight and dust



This equipment is to be used only inside a building. It may only be connected to other equipment that is installed inside a building.

2.2 Safety Instructions



Caution: There are no operator serviceable parts inside the unit

Warning: Use only the Kramer Electronics input power wall adapter that is provided with the unit

Warning: Disconnect the power and unplug the unit from the wall before installing

2.3 Recycling Kramer Products

The Waste Electrical and Electronic Equipment (WEEE) Directive 2002/96/EC aims to reduce the amount of WEEE sent for disposal to landfill or incineration by requiring it to be collected and recycled. To comply with the WEEE Directive, Kramer Electronics has made arrangements with the European Advanced Recycling Network (EARN) and will cover any costs of treatment, recycling and recovery of waste Kramer Electronics branded equipment on arrival at the EARN facility. For details of Kramer's recycling arrangements in your particular country go to our recycling pages at <http://www.kramerelectronics.com/support/recycling/>.

3 Overview

The **VM-50AN** is a high-performance distribution amplifier for balanced and unbalanced stereo audio signals. It takes one balanced or unbalanced stereo input and distributes the signal simultaneously to ten stereo outputs (five balanced and five unbalanced).

In addition, the **VM-50AN** features:

- A balanced/unbalanced input selection button
- Left and right level (gain) controls
- Operation as a stand-alone distributor, or as a companion to other Kramer "50" series products like the **VM-50V** video DA, or the **VM-50YC** s-Video DA

The **VM-50AN** is housed in a desktop sized enclosure. Two units can be rack mounted side-by-side with the optional RK-1 adapter in a 1U rack space.

3.1 Defining the VM-50AN 1:5 Audio Distributor

This section defines the **VM-50AN**.

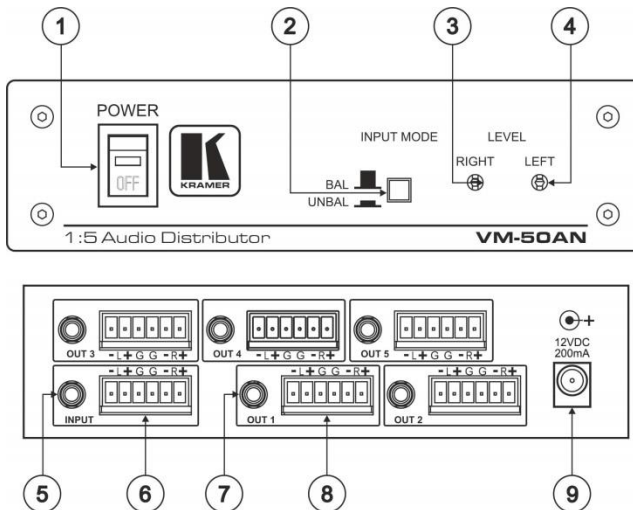

Figure 1: VM-50AN 1:5 Audio Distributor

#	Feature	Function
1	<i>POWER</i> Switch	Illuminated switch supplying power to the unit
2	<i>INPUT MODE BAL/UNBAL</i> Button	When released, selects the balanced stereo audio input when pushed in, selects the unbalanced stereo audio
3	<i>RIGHT LEVEL</i> Trimmer	Adjusts the right output signal level (use a small screwdriver)
4	<i>LEFT LEVEL</i> Trimmer	Adjusts the left output signal level (use a small screwdriver)
5	<i>INPUT</i> 3.5mm Mini Plug Connector	Connects to the unbalanced audio source
6	<i>INPUT</i> Terminal Block Connector	Connects to the balanced audio source
7	<i>OUT</i> 3.5mm Mini Plug Connector	Connects to the unbalanced audio acceptor (from 1 to 5)
8	<i>OUT</i> Terminal Block Connector	Connects to the balanced audio acceptor (from 1 to 5)
9	12 VDC 200mA	+12V DC connector for powering the unit

4 Using Your VM-50AN 1:5 Audio Distributor



Always switch off the power to each device before connecting it to your **VM-50AN**. After connecting your **VM-50AN**, connect its power and then switch on the power to each device.

This section describes how to connect the **VM-50AN** as:

- A balanced stereo 1:5 audio distributor, see [Section 4.1](#)
- An unbalanced stereo 1:5 audio distributor, see [Section 4.2](#)
- A 1:10 audio distributor, see [Section 4.3](#)

4.1 Connecting the VM-50AN as a Balanced Stereo 1:5 Audio Distributor

To connect and operate the **VM-50AN** as a balanced stereo 1:5 audio distributor, as the example in Figure 2 illustrates, do the following:

1. Connect a balanced stereo audio source (for example, a balanced stereo player) to the INPUT terminal block connector.
2. Connect up to five balanced stereo audio acceptors (for example, balanced stereo recorders) to the OUT terminal block connectors.
You do not have to connect all the outputs.
3. Connect the 12V DC power adapter to the power socket, connect the adapter to the mains electricity, and then turn on the power switch.
4. Release the BAL/UNBAL INPUT MODE button to select balanced stereo audio operation.
5. Adjust the right and/or left output signal level, if required.
Insert a screwdriver into the hole and carefully rotate it, to trim the level.

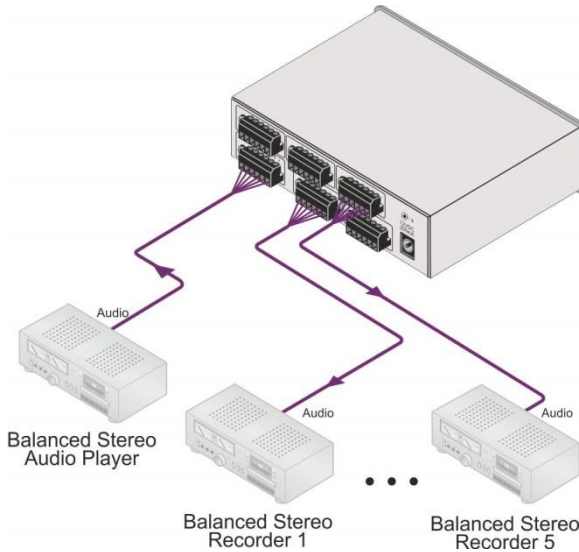

Figure 2: Connecting the VM-50AN as a Balanced Stereo 1:5 Audio Distributor

4.2 Connecting the VM-50AN as an Unbalanced Stereo 1:5 Audio Distributor

To connect the **VM-50AN** as an unbalanced stereo 1:5 audio distributor, as the example in Figure 3 illustrates, do the following:

1. Connect the unbalanced stereo audio source (for example, a PC sound card) to the INPUT mini 3.5mm socket.
2. Connect up to five unbalanced stereo audio acceptors (for example, balanced stereo recorders) to the OUT mini 3.5mm sockets.
You do not have to connect all the outputs.
3. Connect the 12V DC power adapter to the power socket, connect the adapter to the mains electricity, and then turn on the power switch.
4. Push in the BAL/UNBAL INPUT MODE button to select unbalanced stereo audio operation.
5. Adjust the right and/or left output signal level, if required.
Insert a screwdriver into the hole and carefully rotate it, to trim the level.

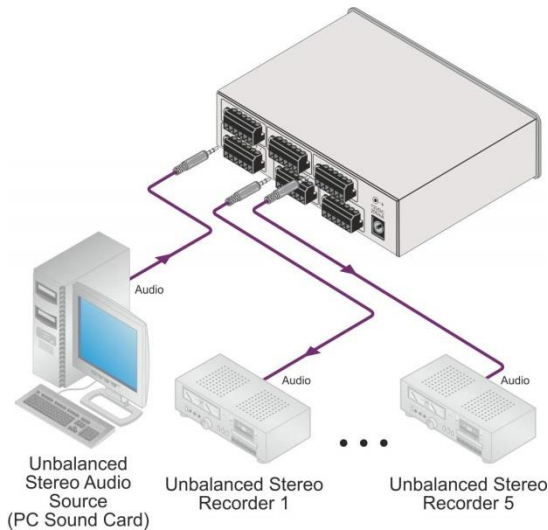

Figure 3: Connecting the VM-50AN as an Unbalanced Stereo 1:5 Audio Distributor

4.3 Connecting the VM-50AN as a 1:10 Audio Distributor

To connect the **VM-50AN** as a 1:10 audio distributor, as the example in [Figure 4](#) illustrates, do the following:



Warning: Both formats cannot be connected to the machine at the same time, as they share some of the input connections

1. Connect either (**but not both simultaneously**) the:
 - Balanced stereo audio source to the INPUT terminal block connector (and release the BAL/UNBAL INPUT MODE button to select balanced stereo audio operation), or
 - Unbalanced stereo audio source to the INPUT mini 3.5mm socket (and push in the BAL/UNBAL INPUT MODE button to select unbalanced stereo audio operation)
2. Connect up to 10 acceptors, as follows:
 - 5 balanced stereo audio acceptors to the OUT terminal block connectors, **and**
 - 5 unbalanced stereo audio acceptors to the OUT mini 3.5mm sockets

3. Connect the 12V DC power adapter to the power socket, connect the adapter to the mains electricity, and then turn on the power switch.
4. Adjust the right and/or left output signal level, if required.
Insert a screwdriver into the hole and carefully rotate it, to trim the level.

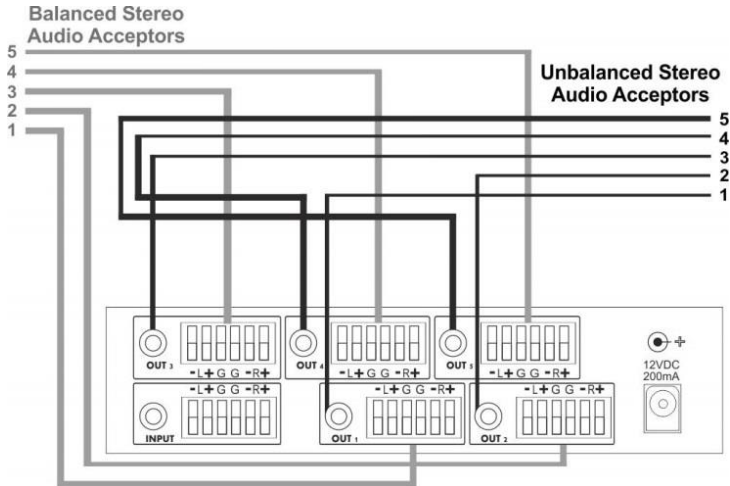

Figure 4: Connecting the VM-50AN as a 1:10 Audio Distributor

5 Technical Specifications

INPUTS:	1 balanced stereo audio, +4dBm 50k Ω on detachable terminal block connector 1 unbalanced stereo audio, 1Vpp/50k Ω on mini 3.5mm socket
OUTPUTS:	5 balanced stereo audio, +4dBm 50 Ω on detachable terminal block connectors 5 unbalanced stereo audio, +22dBm 470 Ω on mini 3.5mm sockets
MAX. OUTPUT LEVEL:	>24dBm
BANDWIDTH:	>40kHz; fully loaded
S/N RATIO:	84dB, unweighted
CONTROLS:	Level (for right and left): 0.4dB to 9.5dB
COUPLING:	Input: AC; Output: DC
AUDIO THD + NOISE:	0.002% @ 1kHz, balanced output
AUDIO 2nd HARMONIC:	0.022% @ 1kHz, balanced output
POWER CONSUMPTION:	12V DC, 200mA
OPERATING TEMPERATURE:	0° to +40°C (32° to 104°F)
STORAGE TEMPERATURE:	-40° to +70°C (-40° to 158°F)
HUMIDITY:	10% to 90%, RHL non-condensing
DIMENSIONS:	16.5cm x 12cm x 4.5cm (6.5" x 4.7" x 1.7", W, D, H)
WEIGHT:	0.6kg (1.3lbs) approx.
ACCESSORIES:	Power supply
OPTIONS:	RK-1 19" rack adapter
Specifications are subject to change without notice at http://www.kramerelectronics.com	

LIMITED WARRANTY

The warranty obligations of Kramer Electronics for this product are limited to the terms set forth below:

What is Covered

This limited warranty covers defects in materials and workmanship in this product.

What is Not Covered

This limited warranty does not cover any damage, deterioration or malfunction resulting from any alteration, modification, improper or unreasonable use or maintenance, misuse, abuse, accident, neglect, exposure to excess moisture, fire, improper packing and shipping (such claims must be presented to the carrier), lightning, power surges, or other acts of nature. This limited warranty does not cover any damage, deterioration or malfunction resulting from the installation or removal of this product from any installation, any unauthorized tampering with this product, any repairs attempted by anyone unauthorized by Kramer Electronics to make such repairs, or any other cause which does not relate directly to a defect in materials and/or workmanship of this product. This limited warranty does not cover cartons, equipment enclosures, cables or accessories used in conjunction with this product.

Without limiting any other exclusion herein, Kramer Electronics does not warrant that the product covered hereby, including, without limitation, the technology and/or integrated circuit(s) included in the product, will not become obsolete or that such items are or will remain compatible with any other product or technology with which the product may be used.

How Long Does this Coverage Last

Seven years as of this printing; please check our Web site for the most current and accurate warranty information.

Who is Covered

Only the original purchaser of this product is covered under this limited warranty. This limited warranty is not transferable to subsequent purchasers or owners of this product.

What Kramer Electronics will do

Kramer Electronics will, at its sole option, provide one of the following three remedies to whatever extent it shall deem necessary to satisfy a proper claim under this limited warranty:

1. Elect to repair or facilitate the repair of any defective parts within a reasonable period of time, free of any charge for the necessary parts and labor to complete the repair and restore this product to its proper operating condition. Kramer Electronics will also pay the shipping costs necessary to return this product once the repair is complete.
2. Replace this product with a direct replacement or with a similar product deemed by Kramer Electronics to perform substantially the same function as the original product.
3. Issue a refund of the original purchase price less depreciation to be determined based on the age of the product at the time remedy is sought under this limited warranty.

What Kramer Electronics will not do Under This Limited Warranty

If this product is returned to Kramer Electronics or the authorized dealer from which it was purchased or any other party authorized to repair Kramer Electronics products, this product must be insured during shipment, with the insurance and shipping charges prepaid by you. If this product is returned uninsured, you assume all risks of loss or damage during shipment. Kramer Electronics will not be responsible for any costs related to the removal or re-installation of this product from or into any installation. Kramer Electronics will not be responsible for any costs related to any setting up this product, any adjustment of user controls or any programming required for a specific installation of this product.

How to Obtain a Remedy under this Limited Warranty

To obtain a remedy under this limited warranty, you must contact either the authorized Kramer Electronics reseller from whom you purchased this product or the Kramer Electronics office nearest you. For a list of authorized Kramer Electronics resellers and/or Kramer Electronics authorized service providers, please visit our web site at www.kramerelectronics.com or contact the Kramer Electronics office nearest you.

In order to pursue any remedy under this limited warranty, you must possess an original, dated receipt as proof of purchase from an authorized Kramer Electronics reseller. If this product is returned under this limited warranty, a return authorization number, obtained from Kramer Electronics, will be required. You may also be directed to an authorized reseller or a person authorized by Kramer Electronics to repair the product.

If it is decided that this product should be returned directly to Kramer Electronics, this product should be properly packed, preferably in the original carton, for shipping. Cartons not bearing a return authorization number will be refused.

Limitation on Liability

THE MAXIMUM LIABILITY OF KRAMER ELECTRONICS UNDER THIS LIMITED WARRANTY SHALL NOT EXCEED THE ACTUAL PURCHASE PRICE PAID FOR THE PRODUCT. TO THE MAXIMUM EXTENT PERMITTED BY LAW, KRAMER ELECTRONICS IS NOT RESPONSIBLE FOR DIRECT, SPECIAL, INCIDENTAL OR CONSEQUENTIAL DAMAGES RESULTING FROM ANY BREACH OF WARRANTY OR CONDITION, OR UNDER ANY OTHER LEGAL THEORY. Some countries, districts or states do not allow the exclusion or limitation of relief, special, incidental, consequential or indirect damages, or the limitation of liability to specified amounts, so the above limitations or exclusions may not apply to you.

Exclusive Remedy

TO THE MAXIMUM EXTENT PERMITTED BY LAW, THIS LIMITED WARRANTY AND THE REMEDIES SET FORTH ABOVE ARE EXCLUSIVE AND IN LIEU OF ALL OTHER WARRANTIES, REMEDIES AND CONDITIONS, WHETHER ORAL OR WRITTEN, EXPRESS OR IMPLIED. TO THE MAXIMUM EXTENT PERMITTED BY LAW, KRAMER ELECTRONICS SPECIFICALLY DISCLAIMS ANY AND ALL IMPLIED WARRANTIES, INCLUDING, WITHOUT LIMITATION, WARRANTIES OF MERCHANTABILITY AND FITNESS FOR A PARTICULAR PURPOSE. IF KRAMER ELECTRONICS CANNOT LAWFULLY DISCLAIM OR EXCLUDE IMPLIED WARRANTIES UNDER APPLICABLE LAW, THEN ALL IMPLIED WARRANTIES COVERING THIS PRODUCT, INCLUDING WARRANTIES OF MERCHANTABILITY AND FITNESS FOR A PARTICULAR PURPOSE, SHALL APPLY TO THIS PRODUCT AS PROVIDED UNDER APPLICABLE LAW.

IF ANY PRODUCT TO WHICH THIS LIMITED WARRANTY APPLIES IS A "CONSUMER PRODUCT" UNDER THE MAGNUSON-MOSS WARRANTY ACT (15 U.S.C.A. §2301, ET SEQ.) OR OTHER APPLICABLE LAW, THE FOREGOING DISCLAIMER OF IMPLIED WARRANTIES SHALL NOT APPLY TO YOU, AND ALL IMPLIED WARRANTIES ON THIS PRODUCT, INCLUDING WARRANTIES OF MERCHANTABILITY AND FITNESS FOR THE PARTICULAR PURPOSE, SHALL APPLY AS PROVIDED UNDER APPLICABLE LAW.

Other Conditions

This limited warranty gives you specific legal rights, and you may have other rights which vary from country to country or state to state.

This limited warranty is void if (i) the label bearing the serial number of this product has been removed or defaced, (ii) the product is not distributed by Kramer Electronics or (iii) this product is not purchased from an authorized Kramer Electronics reseller. If you are unsure whether a reseller is an authorized Kramer Electronics reseller, please visit our Web site at www.kramerelectronics.com or contact a Kramer Electronics office from the list at the end of this document.

Your rights under this limited warranty are not diminished if you do not complete and return the product registration form or complete and submit the online product registration form. Kramer Electronics thanks you for purchasing a Kramer Electronics product. We hope it will give you years of satisfaction.



For the latest information on our products and a list of Kramer distributors, visit our Web site where updates to this user manual may be found.

We welcome your questions, comments, and feedback.

Web site: www.kramerelectronics.com

E-mail: info@kramerel.com



SAFETY WARNING

Disconnect the unit from the power supply before opening and servicing



P/N: 2900-000050



Rev: 3